



**UNIVERSITY OF NOVI SAD**  
**Technical Faculty "Mihajlo Pupin"**  
**Zrenjanin, Republic of Serbia**



**XIII International Conference**  
**Industrial Engineering and**  
**Environmental Protection**  
**IIZS 2023**

**PROCEEDINGS**

**Zrenjanin, Serbia, October 5-6, 2023.**



University of Novi Sad  
Technical Faculty "Mihajlo Pupin"  
Zrenjanin, Republic of Serbia



# **XIII International Conference - Industrial Engineering and Environmental Protection (IIZS 2023)**

Proceedings

Zrenjanin, October 5-6, 2023.

IN COOPERATION WITH PARTNERS:

 <p>UP T Universitatea Politehnica Timișoara</p>	<p>UNIVERSITY POLITEHNICA TIMISOARA, FACULTY OF ENGINEERING, HUNEDOARA, ROMANIA</p>	
	<p>UNIVERSITY «St. KLIMENT OHRIDSKI», TECHNICAL FACULTY, BITOLA, MACEDONIA</p>	
	<p>„AUREL VLAICU” UNIVERSITY OF ARAD, FACULTY OF ENGINEERING, ARAD, ROMANIA</p>	
	<p>UNIVERSITY OF EAST SARAJEVO, FACULTY OF MECHANICAL ENGINEERING EAST SARAJEVO, REPUBLIC OF SRPSKA, B&amp;H</p>	
	<p>UNIVERSITY OF GIRE SUN, FACULTY OF ENGINEERING, GIRE SUN, TURKEY</p>	

# Proceedings of the XIII International Conference - Industrial Engineering and Environmental Protection (IIZS 2023)

## Conference organizer:

Technical Faculty "Mihajlo Pupin", Zrenjanin, University of Novi Sad, Republic of Serbia

## Reviewers:

PhD Bogdana Vujić, Technical Faculty "Mihajlo Pupin", Zrenjanin, Serbia  
PhD Slavica Prvulović, Technical Faculty "Mihajlo Pupin", Zrenjanin, Serbia  
PhD Eleonora Desnica, Technical Faculty "Mihajlo Pupin", Zrenjanin, Serbia  
PhD Ljiljana Radovanović, Technical Faculty "Mihajlo Pupin", Zrenjanin, Serbia  
PhD Vladimir Šinik, Technical Faculty "Mihajlo Pupin", Zrenjanin, Serbia  
PhD Jasmina Pekez, Technical Faculty "Mihajlo Pupin", Zrenjanin, Serbia  
PhD Višnja Mihajlović, Technical Faculty "Mihajlo Pupin", Zrenjanin, Serbia  
PhD Snežana Filip, Technical Faculty "Mihajlo Pupin", Zrenjanin, Serbia  
PhD Una Marčeta, Technical Faculty "Mihajlo Pupin", Zrenjanin, Serbia  
PhD Mića Đurđev, Technical Faculty "Mihajlo Pupin", Zrenjanin, Serbia  
PhD Ivan Palinkaš, Technical Faculty "Mihajlo Pupin", Zrenjanin, Serbia  
PhD Zoran Čepić, Faculty of Technical Sciences. Novi Sad, Serbia  
PhD Marina Naodović, Technical Faculty "Mihajlo Pupin", Zrenjanin, Serbia  
PhD Jasna Tolmač, Technical Faculty "Mihajlo Pupin", Zrenjanin, Serbia  
PhD Saša Jovanović, Technical Faculty "Mihajlo Pupin", Zrenjanin, Serbia  
PhD Sanja Stanisavljev, Technical Faculty "Mihajlo Pupin", Zrenjanin, Serbia  
PhD Edit Terek Stojanović, Technical Faculty "Mihajlo Pupin", Zrenjanin, Serbia  
PhD Mihalj Bakator, Technical Faculty "Mihajlo Pupin", Zrenjanin, Serbia  
PhD Mila Kavalić, Technical Faculty "Mihajlo Pupin", Zrenjanin, Serbia  
PhD Dalibor Dobrilović, Technical Faculty "Mihajlo Pupin", Zrenjanin, Serbia  
PhD Vladimir Brtka, Technical Faculty "Mihajlo Pupin", Zrenjanin, Serbia  
PhD Milija Kraišnik, Mechanical Faculty, East Sarajevo, Bosnia and Herzegovina

## Publisher:

Technical Faculty "Mihajlo Pupin", Zrenjanin, University of Novi Sad, Đure Đakovića bb, 23101 Zrenjanin, Republic of Serbia

## For publisher:

PhD Milan Nikolić, Dean of Technical Faculty "Mihajlo Pupin", Zrenjanin

## Technical preparation:

PhD Jasna Tolmač, Technical Faculty "Mihajlo Pupin", Zrenjanin, Republic of Serbia  
MSc Luka Đorđević, Technical Faculty "Mihajlo Pupin", Zrenjanin, Republic of Serbia  
MSc Borivoj Novaković, Technical Faculty "Mihajlo Pupin", Zrenjanin, Republic of Serbia  
PhD Marina Naodović, Technical Faculty "Mihajlo Pupin", Zrenjanin, Republic of Serbia  
PhD Mića Đurđev, Technical Faculty "Mihajlo Pupin", Zrenjanin, Republic of Serbia

---

Organization of this Conference is supported by the Ministry of Education, Science and Technological Development, Republic of Serbia and The Provincial Secretariat for Higher Education and Scientific Research

---



## CIP Classification

CIP - Каталогизација у публикацији  
Библиотека Матице српске, Нови Сад

62:005.3(082)(0.034.4)

502/504(082)(0.034.4)

**INTERNATIONAL Conference Industrial Engineering and Environmental Protection (13 ; 2023 ; Zrenjanin)**

Proceedings [Elektronski izvor] / XIII International Conference Industrial Engineering and Environmental Protection (IIZS 2023), Zrenjanin, 5-6th October 2023. - Zrenjanin : Technical Faculty "Mihajlo Pupin", 2023. - 1 elektronski optički disk (CD-ROM) ; 12 cm

Nasl. sa naslovnog ekrana. - Bibliografija uz svaki rad.

ISBN 978-86-7672-368-3

а) Индустрijско инжењерство - Зборници б) Животна средина - Заштита - Зборници

COBISS.SR-ID 129354761

## **SCIENTIFIC COMMITTEE - TECHNICAL FACULTY „MIHAJLO PUPIN“**

PhD Slavica Prvulović, Technical Faculty "Mihajlo Pupin", Zrenjanin, Serbia  
PhD Ljiljana Radovanović, Technical Faculty "Mihajlo Pupin", Zrenjanin, Serbia  
PhD Bogdana Vujić, Technical Faculty "Mihajlo Pupin", Zrenjanin, Serbia  
PhD Eleonora Desnica, Technical Faculty "Mihajlo Pupin", Zrenjanin, Serbia  
PhD Vladimir Šinik, Technical Faculty "Mihajlo Pupin", Zrenjanin, Serbia  
PhD Jasmina Pekez, Technical Faculty "Mihajlo Pupin", Zrenjanin, Serbia  
PhD Snezana Filip, Technical Faculty "Mihajlo Pupin", Zrenjanin, Serbia  
PhD Višnja Mihajlović, Technical Faculty "Mihajlo Pupin", Zrenjanin, Serbia  
PhD Jelena Stojanov, Technical Faculty "Mihajlo Pupin", Zrenjanin, Serbia  
PhD Jasna Tolmač, Technical Faculty "Mihajlo Pupin", Zrenjanin, Serbia  
PhD Mića Đurđev, Technical Faculty "Mihajlo Pupin", Zrenjanin, Serbia  
PhD Ivan Palinkaš, Technical Faculty "Mihajlo Pupin", Zrenjanin, Serbia

## **INTERNATIONAL SCIENTIFIC COMMITTEE**

PhD James G. Speight, CD&W Inc., Laramie, Wyoming, USA  
PhD. dr Hosam E.A.F. Bayoumi Hamuda, Obuda University, Budapest, Hungary  
PhD Svetlana Lilkova, University of Architecture, Civil Engineering and Geodesy (UACEG), Faculty of Hydraulic Engineering, Sofia, Bulgaria  
PhD Dimitar G. Petrov, Technical University Sofia, branch Plovdiv, Bulgaria  
PhD Valentina Emilia Balas, „Aurel Vlaicu” University of Arad, Faculty of Engineering, Arad, Romania  
PhD Imre Kiss, University Politehnica Timisoara, Faculty of engineering, Hunedoara, Romania  
PhD Simona Dzitac, University of Oradea, Energy Engineering and Industrial Management Faculty, Oradea, Romania  
PhD Francisc Popescu, University Politehnica Timisoara, Timisoara, Romania  
PhD Mukrimin Sevket Guney, University of Giresun, Faculty of Engineering, Giresun, Turkey  
PhD Muharrem Hilmi Aksoy, Selcuk University, Engineering Faculty, Konya, Turkey  
PhD Alexander Salnikov, Ukhta State Technical University (USTU), Ukhta, Republic of Komi, Russia  
PhD Hrvoje Glavaš, Josip Juraj Strossmayer University of Osijek, Faculty of Electrical Engineering, Computer Science and Information Technology, Osijek, Croatia  
PhD Tomislav Barić, Josip Juraj Strossmayer University of Osijek, Faculty of Electrical Engineering, Computer Science and Information Technology, Osijek, Croatia  
PhD Marijana Hadzima-Nyarko, Josip Juraj Strossmayer University of Osijek, Faculty of Civil Engineering, Osijek, Croatia  
PhD Silva Lozančić, Josip Juraj Strossmayer University of Osijek, Faculty of Civil Engineering, Osijek, Croatia  
PhD Mirko Karakašić, University of Slavonski Brod, Faculty of Mechanical Engineering Slavonski Brod, Slavonski Brod, Croatia  
PhD Vangelce Mitrevski, University «sv. Kliment Ohridski», Technical Faculty, Bitola, Macedonia  
PhD Milija Kraišnik, University of East Sarajevo, Faculty of Mechanical Engineering, Republic of Srpska, Bosnia and Herzegovina  
PhD Mirjana Vojinovic Miloradov, professor emeritus, University of Novi Sad, Faculty of Technical Sciences, Novi Sad, Serbia  
PhD Bratislav Blagojevic, University of Niš, Faculty of Mechanical Engineering, Niš, Serbia  
PhD Blaža Stojanovic, University of Kragujevac, Faculty of Engineering, Kragujevac, Serbia  
PhD Dragan D. Milanovic, University of Belgrade, Faculty of Mechanical Engineering, Belgrade, Serbia  
PhD Mijodrag Milošević, University of Novi Sad, Faculty of Technical Sciences, Novi Sad, Serbia  
PhD Dejan Lukic, University of Novi Sad, Faculty of Technical Sciences, Novi Sad, Serbia  
PhD Milan Rackov, University of Novi Sad, Faculty of Technical Sciences, Novi Sad, Serbia  
PhD Jasmina Radosavljevic, University of Niš, Faculty of Occupational Safety, Niš, Serbia  
PhD Amelija Đorđević, University of Niš, Faculty of Occupational Safety, Niš, Serbia  
PhD Snežana Dragicevic, University of Kragujevac, Faculty of Technical Sciences, Cacak, Serbia

PhD Ivona Radovic, University of Belgrade, Faculty of Technology and Metallurgy, Belgrade, Serbia  
PhD Mirjana Kijevcanin, University of Belgrade, Faculty of Technology and Metallurgy, Belgrade, Serbia  
PhD Aleksandra Sretenovic, University of Belgrade, Faculty of Mechanical Engineering, Belgrade, Serbia  
PhD Aleksandra Mihailovic, University of Novi Sad, Faculty of Technical Sciences, Novi Sad, Serbia  
PhD Nebojša Ralevic, University of Novi Sad, Faculty of Technical Sciences, Novi Sad, Serbia  
PhD Maja Petrovic, University of Novi Sad, Faculty of Technical Sciences, Novi Sad, Serbia  
PhD Zoran Cepic, University of Novi Sad, Faculty of Technical Sciences, Novi Sad, Serbia  
PhD Aleksandar Ašonja, University Business Academy in Novi Sad, Faculty of Economics and Engineering Management in Novi Sad, Serbia  
PhD Marina Milovanovic, University "Union – Nikola Tesla", Faculty for entrepreneurial business and real estate management, Belgrade, Serbia  
PhD Jasmina Perišić, University "Union – Nikola Tesla", Faculty for entrepreneurial business and real estate management, Belgrade, Serbia  
PhD Jordana Ninkov, Senior Research Associate, Institute of Field and Vegetable Crops, Novi Sad, Serbia  
PhD Marko Ristić, Research Associate, Institute Mihajlo Pupin, Belgrade, Serbia

## **ORGANIZING COMMITTEE**

### **PhD Mića Đurđev, Technical Faculty "Mihajlo Pupin", Zrenjanin, Serbia, chairman**

PhD Višnja Mihajlović, Technical Faculty "Mihajlo Pupin", Zrenjanin, Serbia  
PhD Ljiljana Radovanović, Technical Faculty "Mihajlo Pupin", Zrenjanin, Serbia  
PhD Snezana Filip, Technical Faculty "Mihajlo Pupin", Zrenjanin, Serbia  
PhD Slavica Prvulović, Technical Faculty "Mihajlo Pupin", Zrenjanin, Serbia  
PhD Eleonora Desnica, Technical Faculty "Mihajlo Pupin", Zrenjanin, Serbia  
PhD Bogdana Vujić, Technical Faculty "Mihajlo Pupin", Zrenjanin, Serbia  
PhD Jasmina Pekez, Technical Faculty "Mihajlo Pupin", Zrenjanin, Serbia  
PhD Vladimir Šinik, Technical Faculty "Mihajlo Pupin", Zrenjanin, Serbia  
PhD Jasna Tolmač, Technical Faculty "Mihajlo Pupin", Zrenjanin, Serbia  
PhD Zoran Čepić, Faculty of Technical Sciences, Novi Sad, Serbia  
PhD Marina Naodović, Technical Faculty "Mihajlo Pupin", Zrenjanin, Serbia  
PhD Una Marčeta, Technical Faculty "Mihajlo Pupin", Zrenjanin, Serbia  
MSc Borivoj Novaković, Technical Faculty "Mihajlo Pupin", Zrenjanin, Serbia  
MSc Luka Đorđević, Technical Faculty "Mihajlo Pupin", Zrenjanin, Serbia  
BSc Dejan Bajić, Technical Faculty "Mihajlo Pupin", Zrenjanin, Serbia  
PhD Ivan Palinkaš, Technical Faculty "Mihajlo Pupin", Zrenjanin, Serbia



XIII International Conference - Industrial Engineering and Environmental Protection (IIZS 2023) is financially supported by  
*Ministry of Education, Science and Technological Development,  
Republic of Serbia, and  
The Provincial Secretariat for Higher Education and Scientific Research*

# INTRODUCTION

---

Department of Mechanical Engineering and Department of Environmental Protection of Technical Faculty "Mihajlo Pupin" Zrenjanin have organized the XIII International Conference Industrial Engineering and Environmental Protection – IIZS 2023. The first international conference IIZS was organized in October 2011, and since October 2017, two departments have jointly participated in organizing this event. The topics of the scientific conference cover the fields of Industrial engineering and Environmental protection: Mechanical engineering, Energetics and Process Technique, Design and Maintenance, Oil and Gas Engineering, Health and Environmental Protection, Environmental Management, Occupational Safety, and Engineering management.

This year, IIZS was organized in a hybrid manner. Received and accepted papers were presented orally on the premises of the Technical faculty "Mihajlo Pupin" Zrenjanin and online using the Zoom platform. A specific number of papers was presented through posters. The Proceedings of IIZS 2023 contains 69 papers from 198 participants, among whom 49 are foreign authors. Besides Serbia, the authors come from 12 countries: Croatia, Bosnia and Herzegovina, Romania, India, Iran, Turkey, Bulgaria, Denmark, China, Montenegro, Slovenia, Austria, and Slovakia.

The main objectives of the IIZS 2023 conference are to innovate and expand engineering knowledge from industry and environmental protection, provide support to researchers in presenting their research results, establish new contacts with leading national and international institutions and universities, popularize the faculty and its leading role in our society and its immediate environment, draw the attention of diligent young researchers to study at our faculty, cooperate with other organizations, public companies, and industry, initiate collection of new ideas in solving specific practical problems, introduce professional and business organizations to results of scientific and technical research, present scientific knowledge and exchange experiences regarding the topics of the conference program.

We wish to express our gratitude to our long-term partners of the conference – „Aurel Vlaicu” the University of Arad, Faculty of Engineering, Arad, Romania, University “St. Kliment Ohridski,” Technical faculty, Bitola, Macedonia, University Politehnica Timisoara, Faculty of engineering, Hunedoara, Romania, University of East Sarajevo, Faculty of mechanical engineering East Sarajevo, B&H, Republic of Srpska, and University of Giresun, Faculty of Engineering, Giresun, Turkey for supporting the organization of IIZS 2023. We are also grateful to all the authors who have contributed with their papers to organizing the scientific meeting IIZS 2023.

We want to extend our special thanks to the Technical faculty “Mihajlo Pupin” Zrenjanin and Dean Prof. Ph.D. Milan Nikolic for their active support concerning the organization of IIZS 2023. Also, our gratitude goes to the Ministry of Education, Science and Technological Development, Republic of Serbia, for providing financial support to organize this event.

The IIZS Conference became a traditional meeting of researchers from all over the world every year. We are open to and thankful for all valuable suggestions that could contribute to the next International Conference on Industrial Engineering and Environmental Protection organizationally and technically.

**Chairman of the Organizing Committee**  
Assist. Prof. Mića Đurđev, PhD

Zrenjanin, October 5-6, 2023.



**Conference participants are from the following countries:**



Romania



Bosnia and Herzegovina



Austria



North Macedonia



Bulgaria



Croatia



Slovakia



Serbia



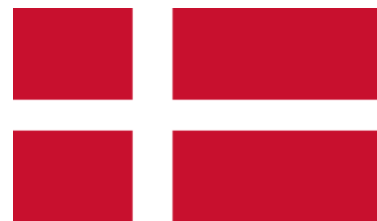
Montenegro



Turkey



Iran



Denmark



India



China



Slovenia

# CONTENTS

## PLENARY SESSION

THE DEVELOPMENT OF MATHEMATICAL MODELS OF VISCOUS FLUID FLOW AND ARISING ISSUES ( <b>Maša Bukurov, Nikola Oluški</b> ) .....	2
TOWARD A CIRCULAR ECONOMY: WASTE VALORIZATION FOR THE PRODUCTION OF BIODIESEL AND ENRICHED PELLETS ( <b>Gorica R. Ivaniš, Zoran V. Simić, Sofija P. Miškov Panić, Mirjana Lj. Kijevčanin, Ivona R. Radović</b> ) .....	9
MACHINE LEARNING APPLICATIONS IN FOOD ENGINEERING AND DISEASE DETECTION ( <b>Gururaj H L</b> ) .....	15
REPLACEMENT OF FLUORESCENT LIGHT SOURCES WITH LED ( <b> Hrvoje Glavaš, Zorislav Kraus, Zvonimir Klaić, Stjepan Kočevar</b> ) .....	22
ANALYSIS OF THE PRODUCTIVITY OF PERFORMING ENERGY RENOVATION WORKS ( <b>Silva Lozančić, Držislav Vidaković, Naida Ademović, Marijana Hadzima-Nyarko</b> ) .....	30

## ORAL / POSTER PRESENTATION

### Session 1: Mechanical Engineering

OUT OF PLANE VIBRATIONS OF CRACKED CURVED PIPES CONVEYING FLUID ( <b>Dimitar Lolov, Svetlana Lilkova-Markova</b> ).....	40
INTERNATIONAL ACTIVITIES OF MECHANICAL ENGINEERING STUDENTS AT THE TECHNICAL FACULTY "MIHAJLO PUPIN" ZRENJANIN ( <b>Eleonora Desnica, Višnja Mihajlović, Ljiljana Radovanović, Simona Džitac, Jasmina Pekez</b> ).....	45

THE ROLE OF CERIUM AS RARE EARTH ELEMENT AT ONE HOT WORK TOOL STEEL ( <b>Zoran Karastojković, Nikola Bajić, Jasmina Pekez, Zoran Janjušević</b> ) .....	50
SYNERGIC AND DEVELOPMENTAL MULTIDISCIPLINARY IN MAINTENANCE OF COMPLEX TECHNICAL SYSTEMS IN ONLINE ENVIRONMENT ( <b>Zlatko Lacković, Milan Ivanović, Krešimir Lacković</b> ) .....	56
OPTIMIZATION OF CUTTING PARAMETERS FOR MAXIMIZING PROFIT RATE IN MILLING USING A DETERMINISTIC APPROACH ( <b>Milan Trifunović, Miloš Madić</b> ) .....	64
FUME EXTRACTION SYSTEMS FOR TEXTILE LASER CUTTING MACHINES ( <b>Ineta Nemeša, Marija Pešić, Borislav Stoyanov, Valentina Bozoki</b> ) .....	72
ENHANCING TRAFFIC SAFETY AND EFFICIENCY THROUGH DEEP LEARNING-BASED IMAGE PROCESSING WITH TENSORFLOW IN TRANSPORTATION ( <b>Dragan A. Milošević, Dragoljub Ilić, Mića Djurdjev, Miroslav Vulić</b> ) .....	79
HARDNESS TEST OF 3D PRINTED SPECIMEN FROM ABS PLASTIC ( <b>Dušan Jovanić, Valentina Mladenović, Ljubica Lazić Vulićević</b> ) .....	86
PREDICTING SURFACE ROUGHNESS IN THE MILLING OF BIOCOMPATIBLE ALLOY TI-6AL-4V ( <b>Igor Babić, Lana Šikuljak, Aleksandar Košarac, Slaviša Moljević, Milenko Sekulić, Borislav Savković, Anđelko Aleksić</b> ) .....	94
THE CURRENT STATE OF ART ON MICROFORMING ( <b>Jelica Anić, Mladomir Milutinović, Milija Krašnik, Slaviša Moljević</b> ) .....	105
ROBOTIC PROCESS AUTOMATION AND TEST AUTOMATION: EFFECTS ON BUSINESS PROCESSES AND SOFTWARE DEVELOPMENT PROCESSES ( <b>Sabri Yalçın</b> ) .....	113
NUMERICAL ANALYSIS OF GAS-SOLID FLOW IN A REVERSE FLOW CYCLONE SEPARATOR ( <b>Muharrem Hilmi Aksoy, Ali Öner, Muhammed Osman Duman, Mert Turan</b> ) ..	118

## **Session 2: Energetics and Process Technique**

THERMODYNAMIC ANALYSIS OF A SOLAR WALL SYSTEM FOR AIR HEATING AND ENERGY STORAGE ( <b>Snežana Dragičević</b> ) .....	128
TEMPERATURE BEHAVIOR OF THERMAL CONDUCTIVITY OF COMPOUND CRYSTALLINE NANOSTRUCTURES ( <b>Dušan I. Ilić, Nikola R. Vojnović, Siniša M. Vučenović, Jovan P. Šetrajčić</b> ) ...	135
PRELIMINARY RESULTS ON ENERGETIC POTENTIAL FOR DIFFERENT TYPES OF BIOMASS BASED MATERIALS ( <b>Bacoș Timotei Bogdan, Cioablă Adrian Eugen, Luisa Izabel Dungan, Aleksandar Djuric</b> ) .....	141
THE CLIMATE-FRIENDLY CAR DEALERSHIP ( <b>Momir Tabakovic, Mihajlo Keseric</b> ).....	148
RELIABILITY OF THE BIOGAS PLANT ( <b>Jovana Radnović, Ljiljana Radovanović, Marko Ristić, Borivoj Novaković</b> )..	156

## **Session 3: Designing and Maintenance**

SOFTWARE INFORMATION SECURITY MANAGEMENT FOR GOVERNMENT AUTHORITIES ( <b>Rade Dragović, Sanja Stanisavljev, Dalibor Dobrilović, Dragan Dragović, Vladimir Milošev</b> ) .....	166
NUMERICAL SIMULATION AND VERIFICATION OF SINK MARKS ON THE MANUFACTURED PLASTIC PARTS ( <b>Ivan Matin, Branko Štrbac, Milana Mićunović Ilić, Miloš Ranisavljev, Miodrag Hadžistević, Zorana Lanc</b> ) .....	174
ANALYSIS OF THE DYNAMIC BEHAVIOR OF HYDRO AGGREGATES WITH AN INSTALLED CAPACITY OF 55 MW ( <b>Slobodan Juric, Slavica Prvulovic, Jasna Tolmac, Luka Đorđević, Ljubisa Josimovic, Milos Josimovic</b> ) .....	180
MACHINE LEARNING FOR PREDICTIVE MAINTENANCE IN INDUSTRY 4.0: CURRENT TRENDS AND CHALLENGES ( <b>Dragan A. Milošević, Dragoljub Ilić, Miroslav Vulić</b> ).....	188

SURFACE ROUGHNESS OPTIMIZATION IN LASER CUTTING BY USING TAGUCHI METHOD  
(**Tamara Šajnović, Dragan Rodić, Marin Gostimirović, Dejan Lukić, Mijodrag Milošević**) ..... 195

RELIABILITY-BASED RISK ASSESSMENT OF AUXILIARY MACHINERY IN OPEN-PIT MINES: CASE STUDY OF A HYDRAULIC EXCAVATOR  
(**Vesna Spasojević Brkić, Nikola Petrović, Uglješa Bugarić**) ..... 200

#### **Session 4: Oil and Gas Engineering**

SELECTION OF THE METHOD OF UNDERGROUND EXPLOITATION OF DEPOSITS ON THE BASIS OF THEIR IMPACT ON THE ENVIRONMENT  
(**Dejan Bogdanović**) ..... 209

BASIC ELEMENTS OF DESIGNING AND CONSTRUCTION OF GAS MEASUREMENT AND REGULATION STATIONS  
(**Jasna Tolmač, Saša Jovanović, Slavica Prvulović, Milan Marković**) ..... 216

#### **Session 5: Engineering Management**

THE APPLICATION OF NEURAL NETWORKS IN FINANCIAL RISK MANAGEMENT  
(**Duško Petrović, Ivana Jošanov-Vrgović**) ..... 224

KNOWLEDGE MANAGEMENT AND INDUSTRY 4.0 TECHNOLOGIES – PRELIMINARY LITERATURE REVIEW  
(**Jelena Slavić, Željko Stojanov**) ..... 231

INVESTIGATING THE IMPLEMENTATION OF INTEGRATED MANAGEMENT SYSTEM (IMS)  
(**Aleksandra Šućurović, Jelena Kiurski Milošević, Eleonora Terečik**) ..... 237

REUSE CENTER LOCATION SELECTION  
(**Ali Reza Afshari, Abdolhossein Sadrnia**) ..... 244

DEVELOPMENT OF AUTOMATION IN THE DIRECTION OF HYPERAUTOMATION  
(**Stanko P. Stankov**) ..... 254

TRUST IN CONSTRUCTION PROJECTS  
(**Ali Reza Afshari, Diana Dast Pak**) ..... 261



NATURAL ENVIRONMENT PROTECTION AS A STAKEHOLDER IN SERBIAN HEALTHCARE SYSTEM ( <b>Tanja Milić, Dragica Milić</b> ).....	269
NEW INDUSTRIAL REVOLUTION WITH INDUSTRY 5.0 LABEL ( <b>Stanko P. Stankov</b> ).....	276
THE INFLUENCE OF INFORMATION TECHNOLOGIES ON THE EFFICIENCY OF PRODUCTION CONTROL ( <b>Vlado Medaković, Bogdan Marić</b> ) .....	284

## **Session 6: Health and Environmental Protection**

REMOTE AND OPEN PATH MONITORING TECHNIQUES APPLIED IN AIR QUALITY MEASUREMENTS IN URBAN AREAS ( <b>Madalina I. Zot, Aleksandar Djurić, Francisc Popescu, Bogdana Vujić, Adrian Cioabla, Una Marčeta</b> ) .....	293
TEXTILE WASTE ( <b>Jasmina Radosavljević, Ana Vukadinović</b> ) .....	298
A SIMULATION MODEL OF AIR POLLUTANTS DISPERSION IN THE BELGRADE CITY AREA ( <b>Adrijana Babić, Zoran Čepić, Jelena Radonić, Borivoj Stepanov, Zorana J. Andersen</b> ).....	305
ANALYTICAL MODELING OF SPATIAL DISTRIBUTION AIR POLLUTANTS FROM STATIONARY POINT SOURCES OF POLLUTION ( <b>Jelena Lamovec, Stevo K. Jaćimovski, Dušan I. Ilić, Jovan P. Šetrajčić</b> ).....	311
THE IMPORTANCE OF USING AIR FILTER IN THE PROCESS OF STEAM STERILIZATION OF MEDICAL WASTE ( <b>Jelena Kiurski-Milošević, Aleksandra Šučurović, Nataša Zec</b> ) .....	319
THE DIAGNOSTICS OF ELASTIC ENERGY OF RELAXATION PROCESSES IN OXYGEN SATURATION TIME IN THE AERATED REFINERY WASTEWATER ( <b>Miladin V. Ševaljević, Stojan N. Simić, Mirjana M. Ševaljević</b> ) .....	323
THE PROCESSES WHICH CONTROL MAXIMALTRANSFER EFFICIENCY OF ELECTRIC POWER INVOLVED IN OXYGEN EQUILIBRIUM DISSOLUTION IN THE AERATED WATER ( <b>Petar V. Ševaljević, Stojan N. Simić, Mirjana M. Ševaljević</b> ).....	331

IMPACT OF RAINFALL ON THE MICROPLASTICS BEHAVIOR IN THE ENVIRONMENT

**(Maja Vujić, Eleonora Terečik, Sanja Vasiljević, Malcolm Watson, Đurđa Kerkez, Jasmina Agbaba, Aleksandra Tubić)** ..... 339

CONTENT OF POTENTIALLY TOXIC ELEMENTS IN SOIL OF URBAN PARKS IN NOVI SAD

**(Aleksandra Mihailović, Robert Lakatoš, Selena Samardžić, Savka Adamović, Jordana Ninkov, Dragan Adamović, Stanko Milić)** ..... 344

LANDFILLS MEET PLASTICIZERS: TRADITIONAL, NOVEL AND SUBSTITUTIONS AND THEIR IMPACT ON THE ENVIRONMENT AND HUMAN HEALTH

**(Tijana Adamov, Ivan Španik, Nemanja Koljančić, Maja Petrović)** ..... 350

FRESH HYPERALKALINE GROUNDWATERS CONTAIN POLYURETHANE-DEGRADING *FLAVOBACTERIUM*

**(Vladimir Šaraba, Jasmina Nikodinovic-Runic, Milica Ciric)**..... 357

## **Session 7: Environmental Management and Occupational Safety**

POTENTIAL IMPACT OF HOME COMPOSTING ON ORGANIC WASTE DIVERSION FROM LANDFILLS IN SERBIA

**(Igor Jezdimirović, Zoran Čepić, Nemanja Stanisavljević, Višnja Mihajlović, Xiaoming Wang)** ..... 363

DETERMINATION OF CHEMICAL PROPERTIES OF SOILS IN ZRENJANIN PARKS  
**(Milana Drašković, Nataša Zec)** ..... 371

CROSS-SECTION OF LAW ON ENVIRONMENTAL PROTECTION LEGAL REQUIREMENTS AND ISO 14001 REQUIREMENTS

**(Marija Perović, David Mitrinović, Marija Todorović)**..... 379

RECENT ADVANCES IN PHOTOCATALYTIC REMOVAL OF EMERGING PHARMACEUTICAL KETOPROFEN – A SHORT REVIEW

**(Mladenka Novaković, Ivana Mihajlović)**..... 384

THE DISTRIBUTION OF CD AND PB BETWEEN THE INTERMEDIATE AND FINAL SINKS IN COMPOSTING AND ANAEROBIC DIGESTION PROCESSES

**(Xiaoming Wang, Nikolina Tošić, Marko Muhadinović, Tijana Marinković, Srđan Kovačević, Nemanja Stanisavljević)** ..... 391

MACHINE LEARNING-BASED ANALYSIS OF NITROGEN REMOVAL IN A WASTEWATER TREATMENT PLANT  
(**Ana Vukmirović, Nikola Jovišić, Slobodan Ilić, Srđan Vukmirović**).....398

THE IMPACT OF POLLUTANTS FROM THE MALJEVAC LANDFILL ON THE SURROUNDING LAND AND WATER OF THE PALESKI STREAM IN MONTENEGRO  
(**Nada Markovic, Nebojsa Ralevic, Miljan Šunjević, Mirjana Vojinovic Miloradov**)  
.....404

## **Session 8: Students Session**

APPLYING MULTICRITERIA ANALYSIS IN SOLAR PANEL SELECTION: INSIGHTS FROM VIKOR METHOD  
(**Luka Djordjević, Borivoj Novaković, Mića Djurdjev, Sanja Stanisavljev, Milan Nikolić**).....411

GREEN MARKETING CONCEPT AS A SIGN OF SUSTAINABLE BUSINESS  
(**Verica Gluvakov, Dragan Čočkaló, Mihalj Bakator, Mila Kavalić, Stefan Ugrinov**)  
.....418

ROLE OF GREEN HUMAN RESOURCE MANAGEMENT IN SMALL AND MEDIUM ENTERPRISES IN CREATING SUSTAINABLE BUSINESS CONCEPT  
(**Stefan Ugrinov, Dragan Čočkaló, Mihalj Bakator, Mila Kavalić, Verica Gluvakov**)  
.....424

GREEN MANAGEMENT AND GREEN ORGANIZATIONAL CULTURE IN MODERN BUSINESS  
(**Dragana Kovač, Edit Terek Stojanović, Maja Gaborov, Igor Vecštejn**).....430

DIGITAL INNOVATIONS AND DIGITAL TRANSFORMATION OF BUSINESS ORGANIZATIONS  
(**Biljana Maljugić, Srđana Taboroši, Dijana Tadić Stanić, Marija Matotek Anđelić, Nenad Dajić**).....436

ONLINE MARKETING AUTOMATION WITH PYTHON-BASED SOCIAL BOT  
(**Vuk Amižić, Ljubica Kazi, Dalibor Šeljmeši, Jovana Borovina**).....442

FOSSIL FASHION: TEXTILE MATERIALS FROM THE OIL AND THE ENVIRONMENTAL RESPONSIBILITY  
(**Valentina Bozoki, Ineta Nemeša, Marija Pešić, Nadiia Bukhonka, Dejan Bajić**)  
.....449

METHODOLOGY FOR CALCULATING THE REQUIRED VOLUME OF CEMENT FOR CEMENTING THE EXPLOITATION CASING AT WELL B-10 <b>(Milan Marković, Dejan Bajić, Branislava Radišić)</b> .....	454
AUTOMATED DECISION SUPPORT SYSTEMS USING ARTIFICIAL INTELLIGENCE IN QUALITY ENGINEERING WITHIN THE AUTOMOTIVE INDUSTRY <b>(Sondra Preascilla Ioana Văcărescu, Nicolae Paraschiv, Valentina Emilia Balas)</b> .....	462
THE STUDY OF WATER PARAMETERS IN AN AQUAPONIC SYSTEM <b>(Daniel Alexuță, Marius M. Bălaș)</b> .....	468
AUTOMATED SYSTEMS IN SMART AGRICULTURE <b>(Marius Susa, Nicolae Paraschiv)</b> .....	475
COMPARISON OF COAL TRANSPORT WITH TRUCKS AND CONVEYORS AT THE SURFACE MINE BOGUTOVO SELO <b>(Radan Lazic, Ljiljana Radovanović, Ivan Palinkaš, Jasmina Perišić)</b> .....	480



**XIII International Conference Industrial  
Engineering and Environmental  
Protection 2023 (IIZS 2023)  
October 05-06, 2023, Zrenjanin, Serbia**

---

# **Plenary Session**





## THE DEVELOPMENT OF MATHEMATICAL MODELS OF VISCOUS FLUID FLOW AND ARISING ISSUES

Maša Bukurov<sup>1</sup>, Nikola Oluški<sup>1</sup>

<sup>1</sup>University of NoviSad, Faculty of Technical Science, Novi Sad, Serbia  
e-mail: [mbukurov@uns.ac.rs](mailto:mbukurov@uns.ac.rs)

**Abstract:** Although the greatest names in science have been grappling with one of the most complex problems for the past three centuries, the problem of turbulent viscous fluid flow has not been represented by a closed system of equations to this day. The attempts of Euler, Navier, Stokes, Bussinesque, Reynolds, Prandtl and others are getting in the last 50 years new support, such as computational fluid dynamics i.e., numerical modeling but also artificial intelligence with its tools such as deep learning and neural networks which are supposed to provide turbulence closure modeling. A historical overview and efforts of modern science and modern techniques are presented in this paper as well as some arising issues.

**Key words:** viscous fluids flow, turbulence modeling, deep learning

### INTRODUCTION

The development of fluid mechanics can be traced through historical data related to the great names of science, primarily mathematicians and physicists, but also engineers, inventors and lovers of the rich field of fluid studies. The first written document about fluid behavior was left to us 250 years B.C. by Archimedes entitled "On floating bodies". Despite the two-millennium study of fluids, to this day we do not have a closed mathematical model that describes the turbulent flow of a viscous fluid.

In 1755 Leonhard Euler (1707-1783) formed his famous equation for ideal fluid flow. After Euler, it appears that only Navier was motivated to formally tackle this problem and to succeed in solving it in 1822. He expanded Euler's equation by introducing the viscous forces. Many investigators had put effort into solving the equation of motion for viscous flows as developed by Navier, and like him, Stokes had a very clear intention on the practicality of his efforts by confronting theory with experiments [1] in the 1830s and 1840s. This may be a reason why he and Navier became associated with the equation of motion for viscous flows. However, it would be fair to call the equation Euler-Navier-Stokes if it is necessary to include in the name the contribution of Stokes which was not fundamental, [1].

The Euler equation is given as:

$$\frac{d\vec{v}}{dt} = \vec{f} - \frac{1}{\rho} \text{grad}p \quad (1)$$

where are:

$\vec{v}$ - velocity vector,  $\vec{f}$ - body forces,  $p$  – pressure,  $\rho$  - density.

Hence the Navier-Stokes (N-S) equations being an extension of Euler's given in vector form also represents nonlinear partial differential equations:

$$\frac{d\vec{v}}{dt} = \vec{f} - \frac{1}{\rho} \text{grad}p + \nu \Delta \vec{v} + \frac{1}{3} \nu \text{grad div} \vec{v} \quad (2)$$

where  $\nu$  is kinematic viscosity. The continuity equation which is coupled with Navier-Stokes equations reads:

$$\frac{\partial \rho}{\partial t} + \text{div}(\rho \vec{v}) = \rho \bar{\varepsilon} \quad (3)$$

where  $\bar{\varepsilon}$  is specific yield of source or sink is also a partial differential equation.

## MATERIAL AND METHODS

The aim of this paper is to present the development of a mathematical model that describes the flow of a viscous fluid, future tendencies and arising issues. In doing so, literary data were used that followed the development of fluid mechanics in the last two and a half centuries. The literature data are in abundance. It takes a lot of time to establish a solid path which can be followed through the labyrinth of investigations, research and experiments conducted by many famous and less famous scientists.

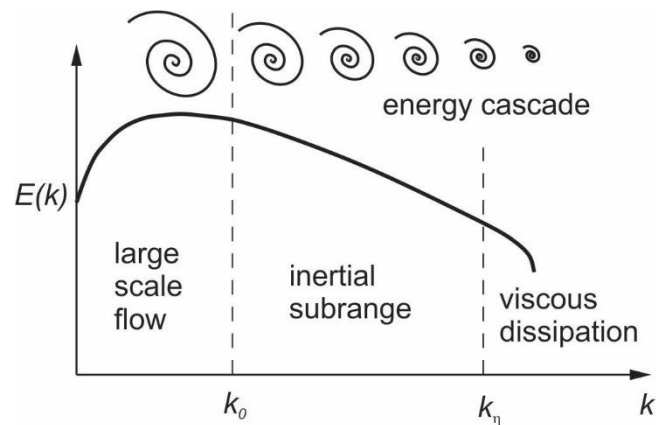
In this paper the main question will be if it is possible to solve one of the hardest problems in fluid mechanics, as well as in computational science, the problem of turbulence modeling, or turbulence closure modeling using modern techniques of deep learning or deep neural networks. Also, what does the future bring in this field from the standpoint of an educator.

In order to design certain objects such as aircraft, ships, submarines or turbine blades it is needed to estimate certain quantities with which the fluid flow field interacts with the objects, such as lift or drag. The starting point in fluid dynamics is the Navier-Stokes equations. They are time and space-dependent conservation of momentum equations. Navier-Stokes equations together with continuity equation represent a set of nonlinear partial differential equations which can be solved analytically only for a certain number of examples for laminar fluid flow in 2D, but solving these equations in 3D is, even nowadays, if not impossible, then extremely difficult, [1]. Previously, engineers made further approximations and simplifications to the equation set until they had a group of equations that they could solve. Contemporarily, high-speed computers have been used to solve approximations to equations using a variety of techniques, e.g., finite difference, finite volume, finite element, and spectral methods, [2].

### Analytical Approach

Today N-S equation represents one of the seven most important unsolved problems established by the Clay Institute of Mathematics. A fundamental problem in analysis is to decide whether such smooth, physically reasonable solutions exist for the Navier-Stokes equations. [3]. There are analytical solutions for the laminar fluid flow examples, but the turbulent flow is much more complicated. It is represented with Reynolds equations which are time-averaged Navier-Stokes equations. By doing so, an unknown term - Reynolds stresses is introduced. They represent the impact of the turbulent fluctuations on the mean flow. The Reynolds equations are partial differential equations of second order and of elliptical type that do not possess analytical solutions. In order to solve these equations, it is necessary to introduce not only time averaging but also some additional hypothesis which will establish a connection between turbulent stresses and averaged velocities.

Flow over an obstacle produces turbulent separated structures over a wide range of scales with existing patterns. Large-scale structures (eddies, vortices) are mainly responsible for either drag, lift or mixing efficiency. It would be an extremely expensive simulation if it would characterize every single degree of freedom. Instead, a reduced order model would be sufficient to present how the big energy-containing structures work together to change the property of interest (e.g. drag on a boundary layer). Kolmogorov turbulent energy cascade shows length scales of existing eddies or vortices in a turbulent flow, Fig. 1.



**Fig. 1.** Kolmogorov turbulent energy cascade

The exact solutions of the Euler equation and Navier–Stokes equation are proposed by different authors using different methods. Among the most effective are Lie group theory and Baecklund transformation, symmetry reduction method [4], or transformation into the linear diffusion equations on a different basis [4-6]. Moreover, the N-S equations are solved by introducing some simplifications, e.g. the Cole-Hopf transformation is applicable for an incompressible flow and allows reducing the Navier-Stokes equation to the Einstein - Kolmogorov equation, [7].

Some authors [8] proposed the conversion of Navier-Stokes equations to a one linear diffusion equation based on the proposed linear velocity operator concept where the velocity operator is formulated in terms of a generalized new physical parameter.

The examples of flows for which analytical solutions are possible to find, with certain restraints, are those through ducts, pipes, coaxial gaps, between two parallel plates, etc. [9]. However, analytical solutions to even the simplest turbulent flows do not exist, [10].

### **Computational Fluid Dynamics (CFD)**

In order to calculate how the object interacts with the fluid, and vice versa, it is necessary to simulate fluid flow to estimate quantities of interest. One way to do that is by using Computational Fluid Dynamics (CFD). CFD is a science that, with the help of digital computers, produces quantitative predictions of fluid-flow phenomena based on the conservation laws (conservation of mass, momentum, and energy) governing fluid motion and it complements experimental and theoretical fluid dynamics [11]. CFD enables analyses of complex problems involving fluid-fluid, fluid-solid or fluid-gas interaction, minimizes the planning time and saves costs of experiments. The results of CFD simulations are numerical solutions of the governing equations of fluid dynamics.

Real flow structures might have many orders of magnitude of scales both in space and time and instead of modeling all of them which is very expensive for computers, it is possible to approximate how small scales affect the big energy-containing scales that are actually of the main interest since they are mostly responsible for a lift and drag. This field is called closure modeling.

The turbulence modeling should enable avoidance simulation of a wide range of turbulent scales and provide closure of turbulence modeling. This field is rapidly progressing with a constant flow of results in literature, and recently the support of artificial intelligence and its tools, machine learning and more advanced deep neural networks, provide a better understanding of turbulence and the possibility of optimizing real fluid flow.

### **Direct Numerical Simulation (DNS)**

Direct Numerical Simulation (DNS) is a research tool of CFD; it does not provide exact solutions to the Navier-Stokes equations for engineering problems. The aim of DNS is to get

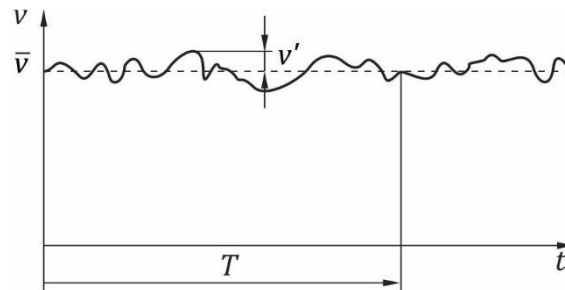
a detailed, both in spatial and temporal scales, model of a flow field, e.g., flow around an airfoil, or a turbine blade. But typically, it is too expensive, and lasts too long; even with Moore's law of exponentially growing computer power, it will still take too much time to simulate the largest scale turbulent problems at all resolutions in space and time, not to mention optimization process which would take even more time. Because of that it is a must to do the turbulence modeling.

### Problem of Turbulence Modeling

One of the most demanding and intriguing problems of fluid mechanics is the problem of turbulence. The wide range of scales of time and space in turbulent flows demands significant resources, both in time and computer configuration to model turbulence.

Turbulent flow is characterized with oscillatory behavior of physical properties; hence they can be represented such as averaged value plus fluctuation, Fig. 2.

$$v = \bar{v} + v' \quad (4)$$



**Fig. 2.** Instantaneous velocity in turbulent flow  $v$ , averaged velocity  $\bar{v}$  and fluctuation  $v'$

In addition to velocity, other turbulent flow properties also show oscillatory characteristics. In order to model a turbulent flow, it is necessary to approximate turbulent stresses, which are too demanding in time and computer power requirements to model. The engineering computation of turbulent flows therefore relies on simpler descriptions with introduction of the statistical consideration of the flow.

Bussinesque proposed methods for presenting viscous stresses, and Reynolds contributed. The work of Prandtl, Kolmogorov, Taylor and von Karman [12] was aimed to characterize turbulence. With the growth of computer power, possibilities of numerical simulations increased, but simplified engineering approximations continue to remain popular and widespread, [13]. There are many approaches [14,15], but the two most common approaches are RANS (Reynolds Averaged Navier-Stokes) and LES (Large Eddy Simulation). The RANS approach is based on time-averaged Reynolds equations and requires closures to represent the turbulent stresses and scalar fluxes emerging from the averaging process. The discipline of turbulence modeling has evolved using a combination of intuition, asymptotic theories and empiricism, while constrained by practical needs such as numerical stability and computational efficiency, [13].

The large eddy simulation (LES) technique of turbulence modelling reducesthecomplexity of simulation by focusing on turbulence on larger length scales and larger time scales, while the smaller scale flow behavior can be described using a subgrid model. The LES technique is an exact method which is still computationally tractable, while the RANS is a less precise method which is more computationally efficient than LES.

### Machine Learning (ML)

Fluid mechanics, with massive amounts of data increasing daily, either from experiments or simulations, is a field with massive potential for machine learning, rapidly becoming an integral part of everyday life.

Simply put, machine learning is building models from data using optimization. More precisely, machine learning algorithms are a growing set of data-intensive optimization and regression techniques ideal for these types of high-dimensional, nonlinear, nonconvex, and constrained optimizations [16].

The essential tasks in fluid dynamics are connected to reduced-order modeling, experimental data processing, shape optimization, turbulence closure modeling, and control [17]. Machine learning can be used for three main objectives:

- 1) to accelerate direct numerical simulations
- 2) to improve modeling basically in the context of LES and RANS and
- 3) to obtain more robust reduced order models, [18].

Machine learning application in fluid dynamics encounters many obstacles, as mentioned in [17]. But this is a very fast-growing field with constant advance which can be seen in papers produced recently in the field of reduced order modeling [19], or for detecting interface between turbulent and non-turbulent flow [20]. One of the most developed segments of ML is image processing. It is also an aspect of ML applicable to improve flow visualization, what is done in [21], where was conducted super-resolution analysis of grossly under-resolved turbulent flow field data. A group of authors [22] used ML to stabilize fluid flow in the wake of a fluidic pinball, and in [23], to stabilize an open cavity flow experiment. In order to improve Reynolds-averaged Navier Stokes (RANS) turbulence models, ML is applied in the paper [24] using a data-driven approach. In [13] is presented how machine learning and data-driven methods are being used to tackle the closure problem and how machine learning can make a practical impact on everyday industrial flows. Optimization problems are also solved increasingly well with the aid of machine learning, and instead of using the full Navier-Stokes equations, which are far too demanding in computer power and time, it is possible to build surrogate models with the aid of ML that are accurate and fast enough to use in real-time for feedback control.

Another mighty tool of ML is deep neural networks (DNN), the dominant data mining tool for big data applications [25], using an artificial neural network with multiple layers between the input and output layers.

In case of RANS modeling in [26] is presented how a custom deep neural network with additional tensor input based on prior physical knowledge can be improved compared with a generic neural network architecture that does not embed this invariance property.

## RESULTS AND DISCUSSION

In the future, mechanics of fluids will take a central role in many fields of human activities, including energy sector, transportation, utility sector, etc. Most of these activities will be enabled by advanced fluid mechanics models and controls, and these tasks can generally be written as challenging optimization problems. These optimizations are nonlinear, non-convex, multi-scale, very high dimensional, and that is exactly where machine learning is significantly advancing.

In the 21st century, computational methods and software tools are put on another level. An increase in computer power has made engineering and scientific computations more available and economically viable. Modeling has become a mainstream step in engineering analysis and design of products, processes, and systems. However, the required training that engineering and science students often receive is not at the adequate level. Therefore, they may not have all the background training required to use software packages. This has created a challenge for industry to have trained professionals who can create "reliable" models and fully utilize commercially available software packages. On the other hand, students, engineers, and scientists may not have the luxury of time and training to learn all the necessary technical subjects like physics, mathematical modeling, numerical methods, and programming languages. Therefore, some arising thoughts and questions are:



- The theory is chasing the praxis, but the experiment remains the primary tool in fluid flow analysis, even though CFD has gone a long way with a lot of data and is constantly advancing. But, we need both experiment and computation [27].
- There is a transition from first principles to data-driven techniques.
- The abundance of data from experimental research and simulations provided a solid base for machine learning. Application of deep learning and neural networks provided additional advancement in closure problems. However, the physical involvement is logical and should be prioritized over the mathematical approach.
- How should the students be thought? There can be two kinds of schools: one deep and broad, and the other will treat the application of CFD and ML as black box. That would lead to two kinds of engineers: engineers with wide knowledge, capable of thinking broadly and capable of introducing new concepts, and engineers who will specialize in a narrow field, with less ability to provide some general solutions. The first approach requires longer education, more devotion and more abundant resources.

## CONCLUSION

Under the umbrella of authority such as Euler, Navier, Stokes, Reynolds, Prandtl, etc., it is difficult to stand out and deviate from the established path. And that is exactly the step that should be taken: to step away from the problem and try to look at it from another angle, by possible expansion of the system boundaries in order to, at least, get nearer to the solution of the turbulence closure problem. The existing transition from first principles (such as the Navier-Stokes equation) to data-driven techniques is exactly such a step which leads us to the solution using another way: ML. What is important is that machine learning should not become a black box and must be connected to physically interpretable and generalizable models which are clear, trustworthy, repeatable under different circumstances and can be interacted with. The most important issue is the future education of engineering and science students and to which extent it should be provided to them.

Educational institutions must embrace a dynamic approach to equip the next generation of engineers with the skills and mindset needed to tackle these complex problems. This involves fostering a deep understanding of both traditional principles and cutting-edge techniques like machine learning. Thus, the paramount challenge ahead is to seamlessly integrate machine learning while reshaping the education of future engineers.

## REFERENCES

- [1] Bistafa, S. R., On the development of the Navier–Stokes equation by Navier, *Revista Brasileira de Ensino de Física*, Vol. 40, No. 2, p.2603, 2018
- [2] Bell, J.B., Colella, P. and Glaz, H.M., A second-order projection method for the incompressible Navier-Stokes equations. *J. Comput. Phys.*, Vol. 85, pp. 257–283, 1989.
- [3] Carlson, J. Jaffe, A. and Wiles, A. Editors: *The Millennium Prize Problems*, Clay Mathematics Institute American Mathematical Society, 2006.
- [4] Liu, M., Li, X., Zhao, Q.: Exact solutions to Euler equation and Navier–Stokes equation. *Zeitschrift fuer angewandte Mathematik und Physik ZAMP*, *Z. Angew. Math. Phys.*, Vol. 70, pp. 43, 2019.
- [5] Gunawan Nugroho, Ahmed M.S. Ali, Zainal A. Abdul Karim: A class of exact solutions to the three-dimensional incompressible Navier–Stokes equations. *Applied Mathematics Letters.*, 23, 1388\_1396 (2010).
- [6] Mohammadein, S. A.1, Gad El-Rab, R.A., and Ali, M.S.: The Simplest Analytical Solution of Navier-Stokes Equations, *Inf. Sci. Lett.* 10, No. 2, 159-165, 2021
- [7] Vladimir V. KULISH\* & José L. LAGE: Exact solutions to the Navier-Stokes equation for an incompressible flow from the interpretation of the Schroedinger wave function.

- School of Mechanical & Aerospace Engineering, Nanyang Technological University, Singapore 639798, Source arXiv, Jan 2013.
- [8] Mohammadein, S. A. New Treatment of Fluid Mechanics with heat and Mass Transfer: Theory of Diffusion. Submitted to Appl. Math & Info Sci Lett.
- [9] Bukurov, Ž., Cvijanović, P.: *Mehanika fluida izbirka zadataka*, Univerzitet u Novom Sadu, Fakultet tehničkih nauka, Novi Sad, 1987.
- [10] Moin, P., Mahesh, K.: DIRECT NUMERICAL SIMULATION: A Tool in Turbulence Research, *Annu. Rev. Fluid Mech.* Vol. 30, pp.539–78, 1998.
- [11] Hu, H.H.: *Computational Fluid Dynamics, Fluid Mechanics, Fifth Edition*, Elsevier Inc., 2012.
- [12] Darrigol, O.: *Worlds of flow: A history of hydrodynamics from the Bernoullis to Prandtl*, Oxford University Press, 2005.
- [13] Duraisamy, K., Iaccarino, G., Xiao, H.: Turbulence Modeling in the Age of Data, *Annual Review of Fluid Mechanics*, No. 51, pp. 1–23, 2019.
- [14] Girimaji, S.S.: Partially-Averaged Navier-Stokes Model for Turbulence: A Reynolds-Averaged Navier-Stokes to Direct Numerical Simulation Bridging Method, *Journal of Applied Mechanics*, Vol. 73 No.3, pp 413-421, 2006.
- [15] Spalart, P. R.: Detached-Eddy Simulation, *Annual review of Fluid Mechanics*, Vol. 41, pp. 181-202, 2009.
- [16] Brunton, S., Kutz, J.N., Manohar, K., Aravkin, A.Y., Morgensen, K., Klemisch, J., Goebel, N., Buttrick, J., Poskin, J., Blom-Schieber, A.W., Hogan, T., McDonald, D.: *Data-Driven Aerospace Engineering: Reframing the Industry with Machine Learning*, Published Online: 20 Jul 2021 <https://doi.org/10.2514/1.J060131>,
- [17] Brunton, S. L., Noack B.R., Koumoutsakos, P.: Machine Learning for Fluid Mechanics, *Annual Review of Fluid Mechanics*, Vol. 52, pp.477-508, 2020.
- [18] Vinuesa, R., Brunton, S.: Enhancing computational fluid dynamics with machine learning, *Nature Computational Science*, Vol. 2, pp. 358–366, 2022.
- [19] Loiseau, J.C., Noack, B.R., Brunton, S.L.: Sparse reduced-order modeling: Sensor-based dynamics to full-state estimation, *Journal of Fluid Mechanics*, Volume 844, pp. 459 – 490, 2018.
- [20] Li, B., Yang, Y., Zhang, X., He, G., Deng, B., Shen, L.: Using machine learning to detect the turbulent region in flow past a circular cylinder, *J. Fluid Mech.*, Vol. 905, A10, 2020.
- [21] Fukami, K., Fukagata, K., Taira, K.: Super-resolution reconstruction of turbulent flows with machine learning, *J. Fluid Mech.*, Vol. 870, pp. 106-120, 2019.
- [22] Maceda, G., Li, Y., Lusseyran, F., Morzynski, M., Noack, B.R.: Stabilization of the fluidic pinball with gradient-enriched machine learning control, *J. Fluid Mech.*, Vol. 917, A42, 2021.
- [23] Maceda, G., Varon, E., Lusseyran, F., Noack, B.R.: Stabilization of a multi-frequency open cavity flow with gradient-enriched machine learning control, *J. Fluid Mech.*, Vol. 955, A20, 2023.
- [24] Grabe, C., Jäckel, F., Khurana, P.: Data-driven augmentation of a RANS turbulence model for transonic flow prediction, *International Journal of Numerical Methods for Heat & Fluid Flow*, Vol. 33 No. 4, pp. 1544-1561, 2023.
- [25] Kutz, J.N.: Deep learning in fluid dynamics, *J. Fluid Mech.*, Vol. 814, pp. 1-4, 2017.
- [26] Ling, J., Kurzawski, A., Templeton, J.: Reynolds averaged turbulence modelling using deep neural networks with embedded invariance, *Journal of Fluid Mechanics*, Vol. 807, pp. 155-166, 2016
- [27] Goldstein, S.: *Fluid Mechanics in the First Half of this Century*, By *Annu. Rev. Fluid Mech.* Vol. 1, p.1-29. 1969.



## TOWARD A CIRCULAR ECONOMY: WASTE VALORIZATION FOR THE PRODUCTION OF BIODIESEL AND ENRICHED PELLETS

Gorica R. Ivaniš<sup>1</sup>, Zoran V. Simić<sup>2</sup>, Sofija P. Miškov Panić<sup>1</sup>, Mirjana Lj. Kijevčanin<sup>1</sup>, Ivona R. Radović<sup>1</sup>

<sup>1</sup>Faculty of Technology and Metallurgy, University of Belgrade, Belgrade, R. Serbia,  
<sup>2</sup>Innovation Centre of the Faculty of Technology and Metallurgy, Belgrade, R. Serbia  
e-mail: [ivonag@tmf.bg.ac.rs](mailto:ivonag@tmf.bg.ac.rs)

**Abstract:** The most common model of linear economy is currently unsustainable, from the economic, energy and ecological aspects. The enormous increase in human needs for various products and energy has led to a reduction in raw material reserves, on the one hand, and the accumulation of waste, on the other. Therefore, it is necessary to widely adopt the circular economy model, where waste is treated as a raw material, with the idea of achieving zero waste production without use of virgin raw materials. In that sense, in this work food and agricultural waste was used to obtain liquid and solid biofuels. Used cooking oil was used as a raw material in the production of biodiesel, while the waste shell of a hen's egg served as the source of a catalyst for the reaction. Glycerine, as a side product of the chemical reaction, was mixed with agricultural and woody biomass in the production of enriched pellets. The fuels obtained in this way were thermodynamically characterized. For biodiesel and glycerine, the density and viscosity at atmospheric pressure and temperatures were measured, while for the mixtures of crude glycerine and biomass, the calorific value was determined. The obtained products show promising characteristics as potential energy source.

**Key words:** waste eggshell, used cooking oil, crude glycerine, biodiesel, biomass, pellet

### INTRODUCTION

The problems related to climate change and global warming, which are partly caused by the emission of greenhouse gases, are becoming more noticeable and serious every day. In addition to the limited reserves of fossil fuels, another issue with their use is the emission of a large amount of greenhouse gases. Therefore, intensive work is being done to replace them and to promote the use of biofuels. The combustion of biodiesel emits 11% less CO and 10% less polluting particles and the net emission of CO<sub>2</sub> is 78% lower than when using diesel [1,2]. Furthermore, the burning of fossil fuels to generate heat leads to the creation of huge amounts of CO<sub>2</sub>, NO<sub>x</sub>, SO<sub>2</sub> and other pollutants, which can be significantly reduced by using biomass-derived pellets.

The goal of the present research is to contribute to the practical application of the circular economy in the field of biofuel production. Biodiesel is obtained by a transesterification reaction between oil/fat and alcohol, with the presence of a catalyst, and glycerol is separated as a side product. Aiming to revalorize waste through the production of biodiesel, the basic raw material was used cooking oil, and the catalyst was obtained from the waste shell of a hen's egg [3]. Furthermore, glycerol, which is produced in significant quantities as a by-product, was further used as an additive in the production of pellets.

Commercial biodiesel production is most commonly a homogeneously catalysed transesterification reaction, where used catalyst is in liquid state. This leads to need for washing biodiesel from the liquid catalyst, where a lot of waste water is created requiring large amounts of energy and means for water purification. That can be avoided by applying a heterogeneously catalyzed reaction, i.e. using solid CaO as a catalyst. This ensures energy and economic savings and reduces the amount of generated waste, which is one of the basic postulates of the circular economy.

Eggshells are hazardous solid organic waste that is mostly accumulated without any prior treatment. The unpleasant smell of egg shell biodegradation, as well as the fact that the egg membrane attracts pests, which causes the spread of diseases, increased the need to find solutions for managing this type of waste. Eggshell contains 96–97%  $\text{CaCO}_3$  with 3–4% organic matter, which indicates a huge potential for its revalorization, such as the production of  $\text{CaO}$ , which serves as a catalyst in the biodiesel production reaction [4].

Disposal of used cooking oil is a huge problem because it is most often poured into drains, which leads to clogging of sewer pipes. In addition, used cooking oil drastically reduces the efficiency of wastewater treatment plants and is extremely harmful to the aquatic ecosystem. Reusing used cooking oil in food is not recommended due to its tendency to turn into trans-fat after use, so other forms of recycling such as biodiesel production are recommended.

The present research proposes to use a catalyst obtained from waste in a very simple way, which makes it extremely cheap, and the basic raw material was also waste - used cooking oil. Thus, in addition to the economic optimization of the biodiesel production process, the problem of waste disposal is also solved, which is a significant additional benefit.

The use of crude glycerol, obtained in significant quantities during the production of biodiesel (1 kg per 10 kg of biodiesel produced), is very limited due to its impurities and variable composition. Crude glycerol is traditionally considered a low-value waste, whose disposal can have harmful impact on the environment, so the issue of its removal is extremely important. Crude glycerol can be integrated with waste biomass, such as agricultural and wood residues, to improve its properties as a fuel. Crude glycerine can serve as a binder in the production of pellets, which increases the yield and durability of pellets during storage and transportation, and also serves as a lubricant, which reduces the energy required for pelletisation. The influence of glycerol additives on the combustion of pellets has been investigated and it was concluded that the thermal efficiency of the boiler in which pellets were used remained almost the same [5,6], while the  $\text{NO}_x$  emission was significantly reduced when burning pellets with glycerol [7].

The aim of the research presented here was to contribute to environmental protection and the reduction of human impact on climate change, by applying main principles of circular economy. Waste egg shell was transferred to  $\text{CaO}$  which served as catalyst in the production of biodiesel (heterogeneous catalysis) from used sunflower cooking oil. The obtained biodiesel and crude glycerine was analysed and their thermodynamic properties were measured. The obtained glycerine was mixed with agricultural and woody biomass and the energy content of such mixtures was analyzed.

## **MATERIAL AND METHODS**

### **Material**

Waste hen's eggshells were provided by Melange, egg processing factory from Belgrade, R. Serbia. Used sunflower cooking oil was collected by the authors in households. Methanol was purchased from Sigma Aldrich with purity of 99.8 mol %.

### **Experimental**

Waste hen's eggshells were collected and thoroughly cleaned and dried in an oven. The clean eggshells were crushed and converted to  $\text{CaO}$  by annealing at 1103.15 K [3]. The used cooking oil was collected, filtered through filter paper and used as the basic raw material for the production of biodiesel. Chemical composition of used oil was determined by a certified laboratory using gas chromatography with flame ionic detector. Biodiesel was synthesized from used cooking oil and methanol (molar ratio of methanol to oil was 10:1) in the presence of heterogeneous  $\text{CaO}$  catalyst. (catalyst/oil weight ratio was 5 %). Transesterification reaction was conducted in a batch reactor at 338.15 K for 2 h [3]. Biodiesel and methanol were separated from glycerol and catalyst using centrifuge and separating funnel, whereas methanol was evaporated in a rotary evaporator (Fig. 1).

Crude glycerine as a side product of the reaction was mixed with waste biomass, beech and wheat straw, in small portions, in order to examine the possibility of its use as an additive in pellet production.



**Fig. 1.** The apparatus used for the biodiesel production

Densities and viscosities of the produced biodiesel and crude glycerine were measured by means of Stabinger viscometer (model SVM 3000/G2) at various temperatures and atmospheric pressure.

The calorific value and element analysis of the mixtures of the obtained crude glycerine and biomass was determined in Institute of nuclear sciences „Vinča“, Department of Thermal Engineering and Energy – „ITE“, Department of Thermal Engineering and Energy – „ITE“.

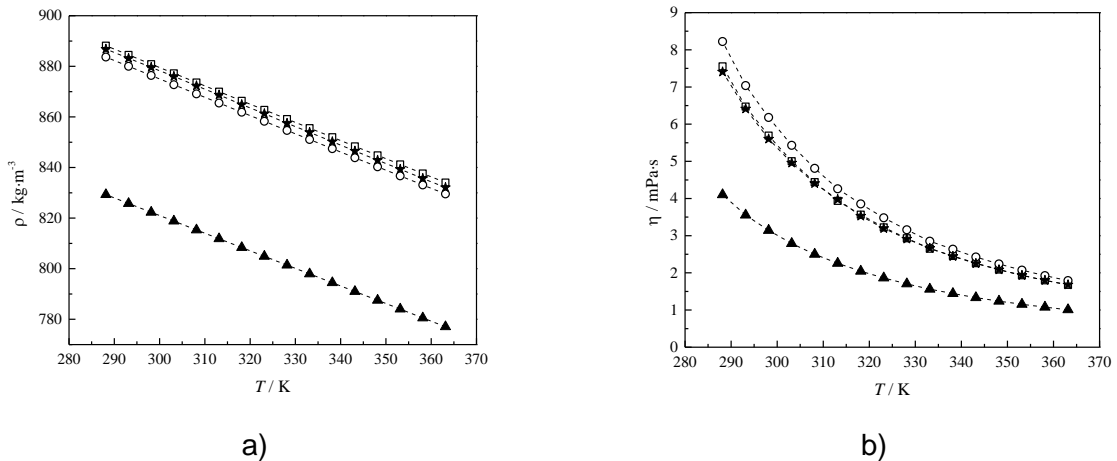
The samples were prepared according to method SRPS CEN/TS 14780: 2011 in a biomass mill Retsch SM 100. The calorific value and element analysis is determined according to the methods SRPS EN ISO 18125:2017 and BS EN ISO 16948: 2015 using IKA C 200 Calorimeter and LECO - CHN 628 with Sulfur module.

## RESULTS AND DISCUSSION

Analysis of the composition of the used sunflower oil showed that it mostly consists of linoleic acid 54.24 g/100g, oleic acid 33.07 g/100g, palmitic acid 7.09 g/100g and stearic acid 3.58 g/100g. Gas chromatography of the obtained biodiesel proved very high yield of the reaction of 99 mas %, which confirms the good quality of the catalyst obtained from eggshell.

Density and viscosity of the obtained biodiesel were measured in temperature range (288.15 - 363.15) K at atmospheric pressure. As expected, density linearly decreases with the increase in temperature, whereas the viscosity dependence on temperature was exponential (Fig. 2). The obtained values fit within the limits prescribed by the standard for biodiesel EN 14214 [8].

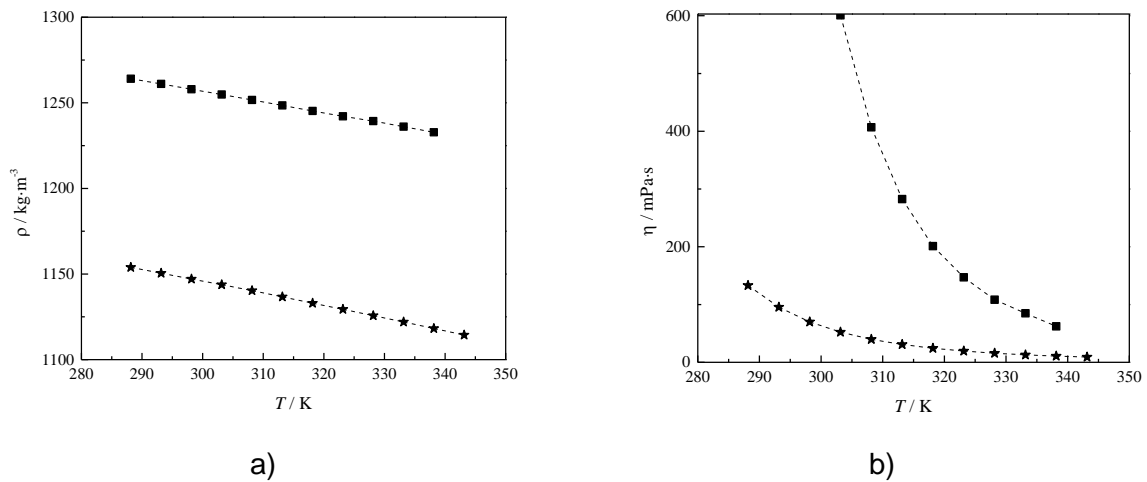
The measured density and viscosity of the produced biodiesel (USME) were compared to the values obtained in the previous research for the biodiesel obtained by methanolysis of pure sunflower oil (SME) [2] and ethanolysis of pure sunflower oil (SEE) [2], and for commercial diesel fuel [9] (Fig. 2).



a) b)  
**Fig. 2.** a) Density and b) viscosity at atmospheric pressure of ( $\square$ ) SME [2], ( $\circ$ ) SEE [2], ( $\star$ ) USME and ( $\blacktriangle$ ) EuroDiesel [9].

It was shown that biodiesel has a higher density and viscosity compared to diesel fuel which is one of the reasons to use lower blends of biodiesel with diesel in diesel engines instead of pure biodiesel [9]. The biodiesel obtained from used sunflower oil has almost identical thermodynamic properties to that obtained from pure sunflower oil. Further, the use of ethanol (SEE) and methanol (SME) in the transesterification reaction gives biodiesels with very similar thermodynamic properties.

Density and viscosity of the produced crude glycerine were measured at temperatures (288.15 - 343.15) K at atmospheric pressure and they exhibited expected dependence on temperature (Fig. 3).



a) b)  
**Fig. 3.** a) Density and b) viscosity at atmospheric pressure of ( $\star$ ) crude glycerine and ( $\blacksquare$ ) pure glycerine [10,11]

The measured density and viscosity of crude glycerine were compared to the values found in literature for pure glycerine [10,11]. The produced crude glycerine was significantly less dense and less viscous than pure glycerine, indicating a certain fraction of impurities in it. On the other hand, high density and viscosity are one of the main challenges when using glycerine, so in that sense crude glycerine has more desirable thermodynamic properties for wider use.

The crude glycerine was mixed with waste biomass, specifically beech and wheat straw, in the fractions of 5 mas % and 10 mas % of glycerine, aiming to investigate the possibility of

producing enriched pellets from such mixtures. The studying of calorific values of the prepared mixtures showed that the addition of crude glycerine increased the calorific value. In the case of beech it was from 17.61 MJ / kg for pure wood to 17.67 MJ / kg (5 mas % of crude glycerine) and 17.85 MJ / kg (10 mas % of crude glycerine), and for wheat straw the increase was from 15.8 MJ / kg to 15.84 MJ / kg (5 mas % of crude glycerine) and 15.88 MJ / kg (10 mas % of crude glycerine).

## CONCLUSION

Within the presented research, biodiesel was obtained from used sunflower oil using a catalyst obtained from a waste shell of a hen's egg. The eggshell, mainly consisting of  $\text{CaCO}_3$ , was converted into a  $\text{CaO}$  by annealing and the quality of the catalyst for the fatty acid transesterification reaction was confirmed by a high reaction yield of 99%. The side product of reaction, crude glycerine, was tested for use as an additive in the production of pellets.

The thermodynamic characterisation of the produced biodiesel and crude glycerine was performed in wide range of temperature at atmospheric pressure. The obtained density and viscosity of biodiesel, as well as its composition and the content of fatty acid methyl esters, met the limits prescribed by European standard for biodiesel (BS EN 14214:2012+A2:2019 [8]).

The measured density and viscosity of crude glycerine were significantly lower than those reported in literature for pure glycerine, which is favourable for its industrial use. Crude glycerine was mixed with beech and wheat straw and it increased their calorific value, indicating its great potential for use in the production of pellets.

The presented research brings mentionable economic and environmental benefits as it offers the solution for the problems, such as disposal of the waste eggshell and used cooking oil, as well as of crude glycerol by their revalorization. It also promotes the use of biofuels, both through the mixing of biodiesel with diesel fuel, and the use of enriched pellets obtained from waste biomass and crude glycerine.

**Acknowledgements:** *This work was supported by United Nations Development Programme and Global Environment Fund (CIRCULAR VOUCHERS – Ref: 00123168/01-01) and by the Ministry of Science, Technological Development and Innovation of the Republic of Serbia (Contracts No. 451-03-47/2023-01/200135 and 451-03-47/2023-01/200287).*

## REFERENCES

- [1] U.S. Department of Energy, [https://afdc.energy.gov/fuels/biodiesel\\_benefits.html](https://afdc.energy.gov/fuels/biodiesel_benefits.html)
- [2] Ivaniš, G.R., Radović, I.R., Veljković, V.B., Kijevčanin, M.Lj., Biodiesel density and derived thermodynamic properties at high pressures and moderate temperatures, *Fuel*, Vol. 165, pp. 244–251, 2016.
- [3] Miškov, S.P., Ivaniš, G.R., Radović, I.R., Kijevčanin, M.Lj., High pressure densities and derived properties of biodiesel fuel produced by heterogeneous transesterification from biowaste, *Thermal Science*, Vol. 23, pp. S1757-S1768, 2019.
- [4] Waheed, M., Yousaf, M., Shehzad, A., Inam-Ur-Raheem, M., Khan, M.K.I., Khan, M.R., Ahmad, N., Abdullah, Aadil, R.M., Channelling eggshell waste to valuable and utilizable products: A comprehensive review, *Trends in Food Science and Technology*, Vol. 106, pp. 78-90, 2020.
- [5] Bala-Litwiniak, A., Radomiak, H., Possibility of the utilization of waste glycerol as an addition to wood pellets, *Waste and Biomass Valorization*, Vol. 10, pp. 2193–2199, 2019.
- [6] Striugas, N., Skvorčinskiene, R., Paulauskas, R., Zakarauskas, K., Vorotinskiene, L., Evaluation of straw with absorbed glycerol thermal degradation during pyrolysis and combustion by TG-FTIR and TG-GC/MS, *Fuel*, Vol. 204, pp. 227–235, 2017.

- [7] Zhang, j., Wang, Y., Muldoon, V.L., Deng, S., Crude glycerol and glycerol as fuels and fuel additives in combustion applications, *Renewable and Sustainable Energy Reviews*, Vol. 159, pp. 112206, 2022.
- [8] BS EN 14214:2012+A2:2019. Liquid petroleum products – fatty acid methyl esters (FAME) for use in diesel engines and heating applications – requirements and test methods.
- [9] Ivaniš, G.R., Radović, I.R., Veljković, V.B., Kijevčanin, M.Lj., Thermodynamic properties of biodiesel and petro-diesel blends at high pressures and temperatures. Experimental and modeling, *Fuel*, Vol. 184, pp. 277–288, 2016.
- [10] Ge, M.L., Ma, J.L., Chu, B., Densities and viscosities of propane-1,2,3-triol + ethane-1,2-diol at  $T = (298.15 \text{ to } 338.15) \text{ K}$ , *Journal of Chemical Engineering Data*, Vol. 55, pp. 2649–2651, 2010.
- [11] Kijevčanin, M. Lj., Zivkovic, E. M., Djordjevic, B. D., Radovic, I. R., Jovanovic, J., Serbanovic, S., Experimental determination and modeling of excess molar volumes, viscosities and refractive indices of the binary systems (pyridine + 1-propanol, + 1,2-propanediol, + 1,3-propanediol, and + glycerol). New UNIFAC-VISCO parameters determination, *Journal of Chemical Thermodynamics*, Vol. 56, pp. 49-56, 2013.





## MACHINE LEARNING APPLICATIONS IN FOOD ENGINEERING AND DISEASE DETECTION

**Gururaj H L<sup>1</sup>**

<sup>1</sup>Department of Information Technology, Manipal Institute of Technology Bengaluru,  
Manipal Academy of Higher Education, Manipal 570064, Karnataka, India  
e-mail: [gururaj.hl@manipal.edu](mailto:gururaj.hl@manipal.edu)

**Abstract**-The development of World Wide Web (WWW) has seen a significant increase in data volume and the emergence of advanced technologies designed to extract valuable insights from this vast data pool, enhancing marketing strategies and enhancing the value of products and services while also delivering personalized customer experiences. In recent times, there has been a remarkable upswing in enthusiasm for the era of Artificial Intelligence and Machine Learning (AI and ML), leading to a growing awareness of the wide range of new possibilities unlocked by ML methods. Firstly, ML offers unique learning strategies and proves its effectiveness in numerous Natural Language Processing (NLP) tasks. Secondly, it possesses the inherent capability to model various features that can effectively capture the nuances of sentiment within text. Nevertheless, it's important to note that while ML approaches may produce results that are not easily understandable by humans, they often enable us to achieve exceptionally high levels of accuracy. On a separate note, Food Engineering is a sophisticated branch of engineering that encompasses various aspects such as food production, quality assessment, innovation in recipe development, nutritional analysis, and food management. Many food engineering tasks involve the utilization of classification and prediction algorithms to enhance processes within the field.

**Keywords:** Artificial intelligence, machine learning, deep learning, transfer learning, healthcare, food technology

### INTRODUCTION

The healthcare industry is swiftly becoming a prominent field for AI and ML research and applications [1], offering significant potential to transform various aspects of healthcare. Machine learning presents exciting opportunities in healthcare to efficiently utilize large amounts of underutilized data, using it to improve outcomes, reduce costs, and deliver higher-quality care. These emerging startups harness the power of AI and ML technologies to create AI-driven solutions that benefit individual consumers, pharmaceutical and biotech companies, and hospital systems. In Figure 1, a diverse range of AI-powered applications is emerging in the healthcare sector, encompassing clinical trial management, privacy protection solutions, drug discovery, wellness programs, genome sequencing, hospital decision support systems, imaging and diagnostics, predictive analytics, risk assessment, remote monitoring, and virtual assistance. Startups in this field leverage machine learning (ML) and natural language processing (NLP) to analyze and integrate medical and health data from various sources. The relationship between good nutrition and a healthy lifestyle is well-established, and food processing plays a significant role in influencing consumer health, consequently impacting the healthcare system. A degree in food science encompasses multiple domains of study, offering direct benefits to the healthcare sector and creating numerous opportunities [3]. Advancements in food engineering technologies will play a crucial role in addressing some of the most pressing challenges on the horizon. Ensuring the sustainable supply, storage, and transportation of energy, clean freshwater, and affordable food for all will be significantly impacted by these developments [4].



Fig. 1. Wide area of AI driven applications

## LITERATURE SURVEY

In this section related work has been elaborated.

### Pharmacovigilance and Adverse Drug Effects (ADE)

Pharmacovigilance encompasses all activities related to the detection and analysis of adverse effects and other issues associated with drugs. Its primary focus is on ensuring the safety of drugs that have been approved and are available on the market. This field involves the assessment, continuous monitoring, and prevention of potentially harmful side effects of drugs, often by analyzing a wide range of data from various online sources. To put things in perspective, statistics show that in the United States alone, adverse drug effects (ADEs) are responsible for one-third of all hospital admissions each year. Pharmacovigilance has become increasingly significant in recent years, representing a vital proactive measure to prevent potential drug side effects. Analyzing drug reviews from various origins is of paramount importance in safeguarding drug safety after their market release, particularly because Adverse Drug Events (ADEs) are one of the most prevalent and avoidable medical problems [5,6].

### Clinical Imaging and Diagnostics

Utilizing machine learning algorithms, computer-assisted detection of symptoms and medical diagnosis for particular medical conditions has the capacity to enhance the capabilities of physicians in interpreting medical imaging outcomes and facilitating more well-informed decision-making [7]. While humans can experience fatigue, leading to a potential decrease in the quality of interpretation, AI-enabled machines can operate continuously and have the ability to recognize patterns that may go beyond human perception. AI-integrated software acts as a valuable companion for medical professionals, aiding in enhancing their productivity through precise interpretations. For example, AI-powered software for diagnosing diabetic retinopathy has demonstrated exceptional accuracy and a high success rate, often eliminating the need for a second opinion from an expert.

### Conversational AI in Healthcare

NLP-based chatbots have the potential to play a crucial role in addressing a wide range of healthcare-related queries and needs across various segments of the healthcare industry [8]. They can serve multiple functions, from raising awareness to offering recommendations and answers to numerous healthcare-related questions, all without the direct involvement of a physician. As a health chatbot continues to learn and adapt independently over time, it can

handle queries in a manner that closely resembles a human physician and provides immediate assistance at the touch of a button. These chatbots can serve as personal aides, arranging patient appointments with doctors at suitable hours and overseeing subsequent follow-up visits. Moreover, in the process of evaluating patients' symptoms, a medical chatbots can direct them to the closest and most suitable healthcare centers.

### **Vegetables and Fruits Assortment**

In food processing facilities, it's important to recognize that vegetables and fruits have distinct characteristics and should not be treated as identical. Even though some fruits and vegetables, like oranges, tomatoes, and apples, may appear similar at a glance, they differ in various attributes. Size, shape, and color are among the key features that distinguish them. TOMRA [9], a leading food sorting technology company, has harnessed these various attributes of fruits and vegetables. They have developed technology capable of viewing food items like how consumers perceive them and sorting them based on this insight, as illustrated in Figure 2. This technology allows for a more precise and efficient sorting process that considers each food item's unique characteristics.



*Fig. 2. Tomato processing and sorting machines (TOMRA)*

### **Personal Hygiene**

In the current pandemic situation, maintaining food hygiene is absolutely crucial for everyone's well-being. Ensuring that food is safe to consume involves not only the cleanliness of the kitchen but also the personal hygiene of the individuals handling the food [10]. One notable company at the forefront of ensuring food worker hygiene is KanKan. They have implemented advanced systems with the ability to recognize objects and human faces. These systems are utilized to confirm whether employees in the food industry are following the prescribed professional standards as required by food safety regulations, including the use of caps, facial masks, and hand gloves.

### **Plant Leaf Disease Detection**

Detecting diseases in crops at an early stage is crucial for farmers as it enables them to take necessary preventive measures to protect their crop yields. Many farmers still rely on traditional farming methods without knowing the condition of the soil or whether pesticides are required. Early disease detection, often achieved by analyzing various plant leaf samples, can significantly improve crop yields. Accurate disease diagnosis in plants eliminates the wastage of human effort and resources that may occur when the presence of disease in a crop goes unnoticed [13]. In addition to traditional methods, satellite images and UAV (Unmanned Aerial Vehicle) images of agricultural plots can provide enhanced accuracy in disease detection compared to using datasets from individual plant images, as depicted in Figure 3.



**Fig. 3.** Plant Disease Detection [11]

### Face Recognition Systems for Domestic Cattle

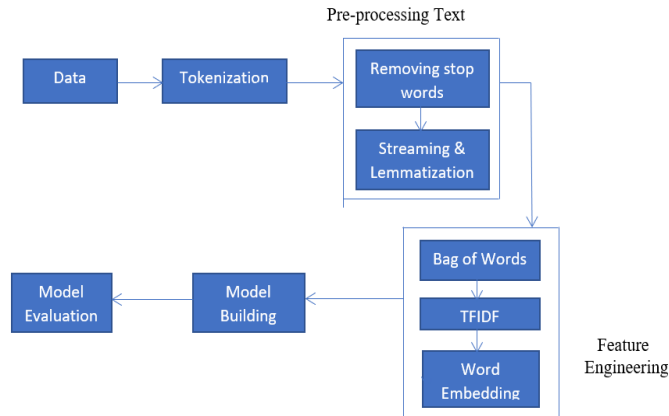
Lameness is a frequent issue in dairy cattle, and it can have indirect effects on milk production. Detecting lameness in cows can provide insights into their willingness to consume more food. The presence of lameness in cattle, as shown in Figure 4, serves as an indicator of the cow's overall well-being and comfort. Addressing lameness and related issues is essential for maintaining the health and productivity of dairy cows, ultimately impacting milk production.



**Fig. 4.** Domestic cattle Lameness[12].

### METHODOLOGY

The dataset poses numerous challenges, including issues like grammatical errors and unclear text, the inclusion of sarcasm, an unequal distribution of sentiments, reviews covering multiple topics with different sentiments in a single text, sentiments expressed on unrelated subjects, and the presence of special characters and emojis, among other factors. In summary, the dataset consists of 5,042 reviews, with the following sentiment breakdown: Positive: 3,737 reviews, Neutral: 592 reviews, Negative: 813 reviews.

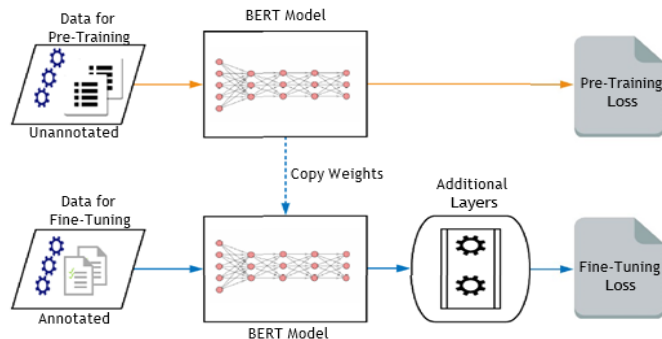


**Fig. 5.** Processing steps in sentiment analysis

The typical processing pipeline for ML-based NLP tasks, as depicted in Figure 5, is commonly followed in practice.

### Deep Learning Model

Deep learning language models like BERT (Bidirectional Encoder Representations from Transformers), ELMo (Embeddings from Language Models), and ULMFiT (Universal Language Model Fine-tuning), trained on extensive text corpora, excel at obtaining deep contextualized word representations. Deep learning has certainly showcased its exceptional potential in a wide range of natural language processing (NLP) tasks, such as text summarization, machine translation, sentiment analysis, and numerous others. These achievements are attributed to the development of language modeling, which has evolved significantly through extensive research efforts. Hence, numerous algorithms that used to feature shallow architectures have evolved into deep learning models. The transfer learning technique, illustrated in Figure 6, has been integrated into the BERT model, a large neural network architecture.



**Fig. 6.** Fine-tuning of pre-trained BERT models

Training a BERT model from the ground up on a limited dataset, despite its vast parameter count, ranging from 100 million to over 300 million, would lead to overfitting.

## RESULTS AND DISCUSSIONS

Table 1 presents the outcomes of various NLP models, including both traditional and deep learning approaches. The experimental results demonstrate that the deep learning models



outperform the traditional ones. Notably, BERT, even though it is pre-trained on a substantial corpus, does not exhibit robust performance without fine-tuning.

**Table 1.** Performance of SA on drug reviews using ML models

Model	Accuracy (%)	Macro-F1-Score
TF-IDF <sub>SVM</sub>	63	0.30
TF-IDF <sub>Logistic</sub>	61	0.29
Bi-LSTM <sub>FCD+Softmax</sub>	70	0.46
BERT <sub>Without_Fine-Tuning</sub>	71	0.45
BERT <sub>With_Fine-Tuning</sub>	75	0.65
BERT <sub>With_Fine-Tuning_Ensemble</sub>	76	0.66

However, when fine-tuned and used in an ensemble with other BERT models, it highlights significantly improved performance through domain adaptation. The enhancements in the deep learning models' performance, especially when dealing with a challenging dataset, can be attributed to several intrinsic features and capabilities of these models. BERT, based on transformer architecture, has the capacity to capture the sequential structure of text and the broader context of sentences, which is a crucial feature for enhancing the language model's overall performance.

## CONCLUSION

Recent progress in machine learning techniques has ushered in many new opportunities in natural language processing (NLP). Deep learning has emerged as a prominent and popular trend in scientific research. It has achieved state-of-the-art results and has brought about a significant transformation in the way NLP models are conceived and designed. Deep learning models have demonstrated their potential across a wide range of NLP tasks, including sentiment analysis, text summarization, machine translation, and more. These models, which are essentially language models, have matured thanks to extensive research efforts, yielding impressive outcomes through neural networks for language representation. As machine learning plays a pivotal role in this evolving technological landscape, its adaptation in food science can lead to improved performance and greater efficiency, benefiting the healthcare sector and beyond.

## REFERENCES

- [1] Devanport, T. and Kalakota, R., The potential for artificial intelligence in healthcare. *Future Healthc. J.*, 6, 2, 94–98, 2019.
- [2] Kuo, E., AI in Healthcare: Industry Landscape, techburst.io, 12 December 2017. [Online], Available: <https://techburst.io/ai-in-healthcare-industry-landscape-c433829b320c>.
- [3] Tahir, G.A. and Loo, C.K., An Open-Ended Continual Learning for Food Recognition Using Class Incremental Extreme Learning Machines. *IEEE Access*, 8, 82328–82346, 2020.
- [4] Min, S., Evrendilek, G.A., Zhang, H.Q., Pulsed electric fields: Processing system, microbial and enzyme inhibition, and shelf life extension of foods. *IEEE Trans. Plasma Sci.*, 35, 1, 59–73, 2007.
- [5] Santosh, K., Speech processing in healthcare: Can we integrate?, in: *Intelligent Speech Signal Processing*, pp. 1–4, 2019.

- [6] Sarker, A., Ginn, R., Nikfarjam, A., O'Connor, K., Smith, K., Jayaraman, S., Upadhaya, T., Gonzalez, G., Utilizing social media data for pharmacovigilance: A review. *J. Biomed. Inform.*, 54, 202–212, 2015.
- [7] Seetharam, K., Kagiya, N., Shrestha, S., Sengupta, P.P., Clinical inference from cardiovascular imaging: Paradigm shift towards machine-based intelligent platform. *Curr. Treat. Options Cardiovasc. Med.*, 22, 3, 1–11, 2020.
- [8] Kidwai, B. and Nadesh, R., Design and development of diagnostic chatbot for supporting primary healthcare systems. *Procedia Comput. Sci.*, Gurugram, 167, 2020, 75–84, 2019.
- [9] Tomra, *Tomato Sorting & Processing Machines By Tomra*, Tomra Systems ASA, 2017, [Online]. Available: <https://www.tomra.com/en/sorting/food/your-produce/vegetables/tomatoes>.
- [10] Tonda, A., Boukhelifa, N., Chabin, T., Barnabé, M., Génot, B., Lutton, E., Perrot, N., *Human and Machine Learning*, Springer, Cham, 2018.
- [11] BitRefine, *Plant disease detection*, BitRefine Group, 2016, [Online]. Available: <https://bitrefine.group/industries/precision-agriculture/88-industries/agriculture-food/agriculture-solutions/184-plant-disease>.
- [12] Shearer, J., Anderson, D., Ayars, W., Belknap, E., Berry, S., Guard, C., Hoblet, K., Hovingh, E., Kirksey, G., Langill, A., Mills, A., A record keeping system for capture of lameness and foot-care information in cattle. *Bov. Pract.*, 38, 1, 83–92, 2004.
- [13] K Paramesha, HL Gururaj, OP Jena, Applications of machine learning in biomedical text processing and food industry, *Machine Learning for Healthcare Applications*, 2021.

## REPLACEMENT OF FLUORESCENT LIGHT SOURCES WITH LED

**Hrvoje Glavaš<sup>1</sup>, Zorislav Kraus<sup>1</sup>, Zvonimir Klaić<sup>1</sup>, Stjepan Kočevar<sup>1</sup>**

<sup>1</sup>Josip Juraj Strossmayer University of Osijek, Faculty of Electrical Engineering,  
Computer Science and Information Technology Osijek, Osijek, Croatia

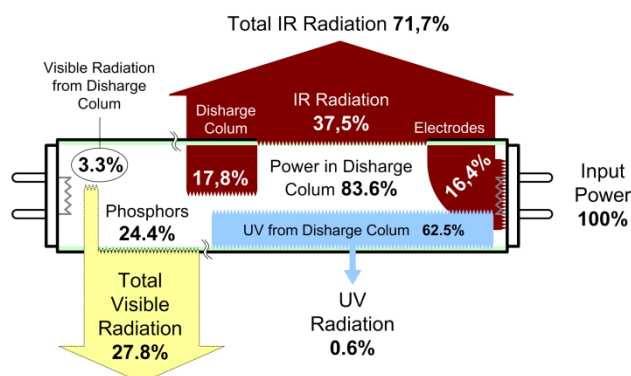
e-mail: [hrvoje.glavas@ferit.hr](mailto:hrvoje.glavas@ferit.hr)

**Abstract:** The replacement of existing light sources with LED technology is usually the result of the pursuit of better energy efficiency as well as trends in interior design (lighting). All technical systems have a lifetime that is difficult to estimate. The analysis performed in this paper is the result of the ballast failure of the office lighting system FLU installed in 1995, which resulted in a short circuit, followed by a noise explosion and partial melting of the copper winding housing. There was no real fire hazard, as protective and design measures prevented more unpleasant consequences than the failure of the lighting in the room. The paper shows the practical steps of lighting replacement from the initial thermographic analysis of the event to the modeling of the room using ReluxDesktop software to identify suitable luminaries that comply with the current standard EN 12464-1, which defines the requirements for lighting indoor workplaces.

**Key words:** FLU, ballast, LED, thermography, Relux

### INTRODUCTION

Fluorescent tubes (FLU) are the common form of lighting in business premises. The reason is economic advantages. FLU Tubes convert more than 20% of electrical energy into a useful form, light [1]. For comparison, classical incandescent bulbs convert 3% to 5% of electrical energy into light, but their (in)efficiency is accepted/tolerated by consumers and is sometimes due to application conditions (high or too low ambient temperatures). While households in the European Union were legislated to switch to more efficient light sources in 2009, in the US the transition to newer technologies begins in 2023 [2]. The figure shows the principle energy balance of the light source FLU according to [1].

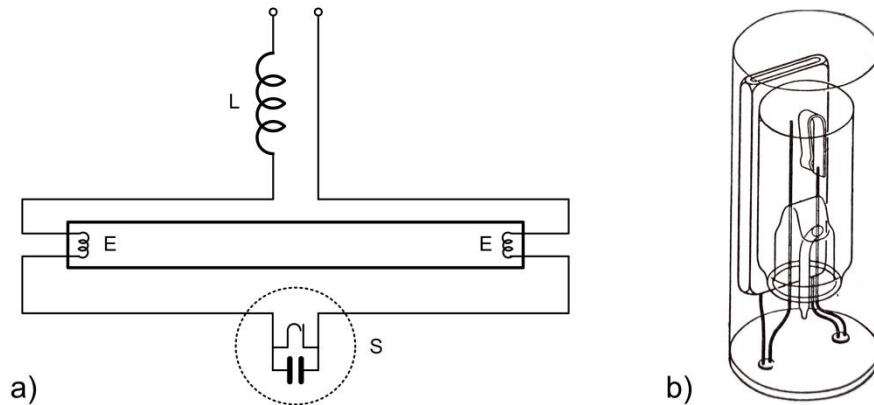


**Fig. 1.** Energy balance of the FLU light source

Almost all business areas that have not been remodeled in the last ten years use some form of FLU tubes as light sources. They work on the principle of fluorescence and photoluminescence. Photoluminescence is a phenomenon in which UV electromagnetic radiation is converted into light with the help of a phosphor coating. There are two types of photoluminescence: materials can emit light while radiation is present, which we call fluorescence, and there are also materials that continue to emit light after excitation ceases, which we call phosphorescence.



Solid materials exhibit both properties, while gases can only exhibit fluorescence. There is a whole range of luminescent materials: phosphorus, beryllium, various silicon-cadmium and zinc compounds, etc. They are all characterized by the fact that the emitted light has a longer wavelength than the excitation wavelength. The mentioned phenomenon was first discovered by George Gabriel Stokes in 1852 [3]. The basic electrical diagram of the light source FLU can be seen in Fig. 2.



**Fig. 2.** Circuit diagram of the FLU lighting system a) and starter switch b)

The principle of operation of the lighting system FLU (see Fig. 2.) is based on the fact that when the lighting system FLU is switched on, the start switch (S) causes a short circuit, heating two tungsten electrodes (E). The heating of the electrodes causes an initial breakthrough of argon, which is ionized at lower voltages and lower temperatures, and the heat generated contributes to the vaporization of mercury vapors. The mercury vapors begin to emit radiation at 253.7 nm, which is converted to visible light on the phosphor layer. To regulate the process and prevent burnout, a ballast is added that causes a voltage drop in the circuit and a decrease in current. The process of voltage drop and current regulation occurs continuously as the voltage of the power system changes. From the energy balance (and the circuit diagram, Fig. 2.), it can be seen that all the energy flows through the ballast, causing it to heat up. In recent times, in order to reduce flicker and switching current, electronic ballasts have been developed, but the physical background of light emission has remained the same.

## REPLACING FLUORESCENT LIGHT SOURCES WITH LED TECHNOLOGY

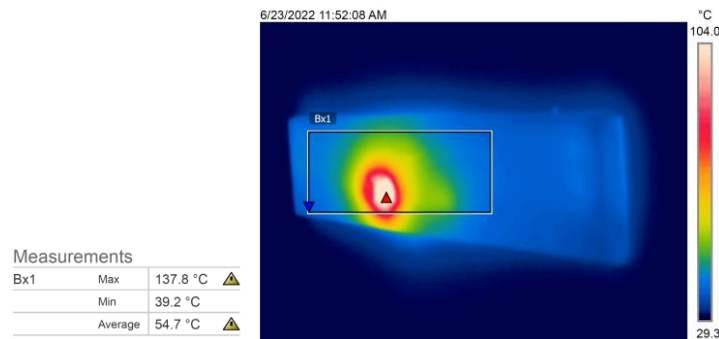
### Analysis of unanticipated failure of FLU lighting ballast

Motivation for this work was the failure (explosion) of the ballast of a FLU lighting fixture located in the cabinet 2-29 of the Faculty of Electrical Engineering, Computing Science and Information Technologies Osijek at the location Kneza Trpimira 2b. The lighting fixture was installed in 1995 as part of the modernization of the lighting system. On average, the light sources (tubes) were replaced every 5 years, while a visual inspection did not reveal any problems with the ballasts (change in color of plastic or connector). On June 23, 2022, the room temperature reached 29 °C. The cabinet, which is protected from the sun by tree canopies, must be artificially illuminated according to EN 12464-1:2021, [4] so the lighting was in operation. An explosion occurred in one of the lamps, accompanied by smoke and unpleasant odor. Thermographic inspection shows the first three minutes of the event, which caused a short circuit and turned off the entire lighting system. Fig. 3. shows the thermal pattern immediately after the explosion.

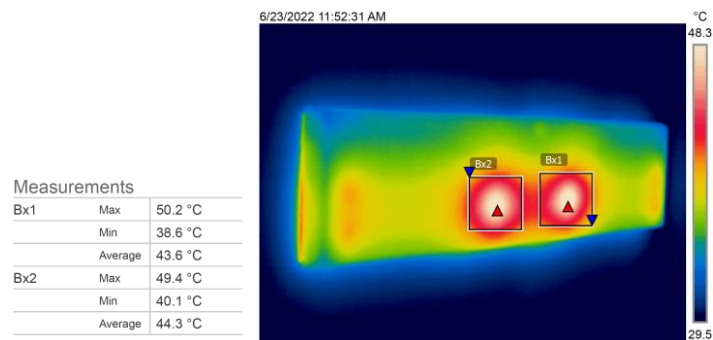


**Fig. 3.** Thermal pattern immediately after ballast failure

Fig. 4. shows a piece of ballast that came loose and fell onto the diffuser of the lamp, causing the temperature to rise to 138 °C. After half a minute, another piece of ballast falls onto the diffuser, but it cools quickly. By removing the diffuser, the cause of the short circuit and the extent of the damage could be determined (Fig. 6. and Fig. 7.).



**Fig. 4.** A piece of molten ballast falls on the base of the diffuser



**Fig. 5.** Two pieces of ballast on the base of the diffuser in gradual cooling

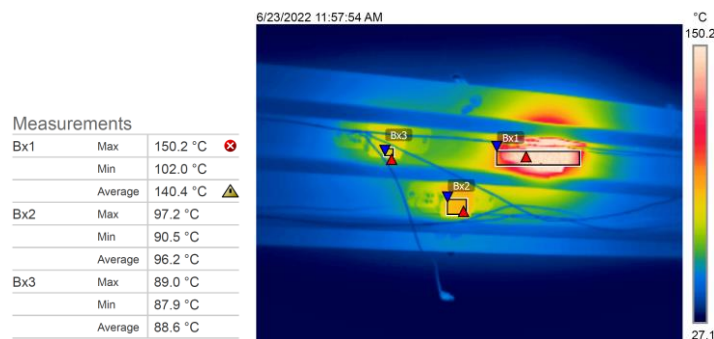


**Fig. 6.** The diffuser of the lighting fixture and pieces of the plastic housing of the ballast previously observed by thermographic inspection



**Fig. 7.** The extent of damage due to a short circuit of one of the ballasts

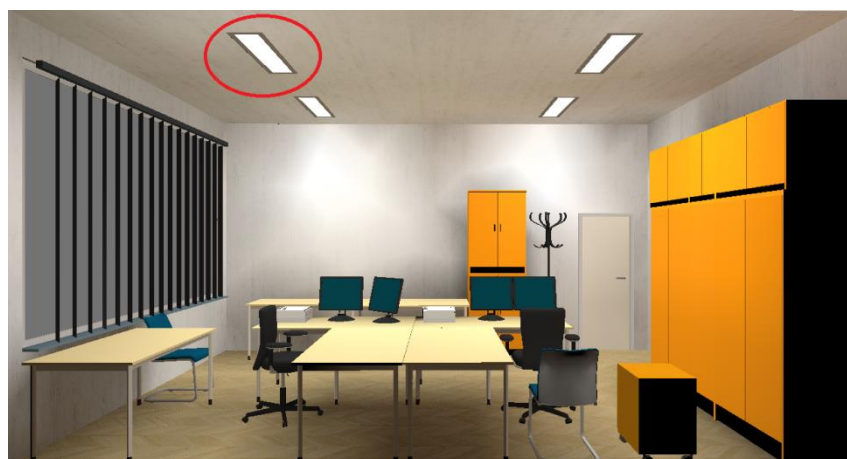
A thermographic inspection of the ballast also revealed the limitations of the Flir 60bx infrared thermal imaging camera, which measures up to 150 °C. The indicated temperature does pose a fire hazard, but due to the sheet metal support separated from the ceiling structure by joints and the design solution, the fire hazard is minimal. The approximate temperature of the other two ballasts can be seen in Fig. 8. and is 90 °C.



**Fig. 8.** Partial thermographic analysis due to the limited temperature range of the camera

### Implementation of corrective actions on the office lighting system

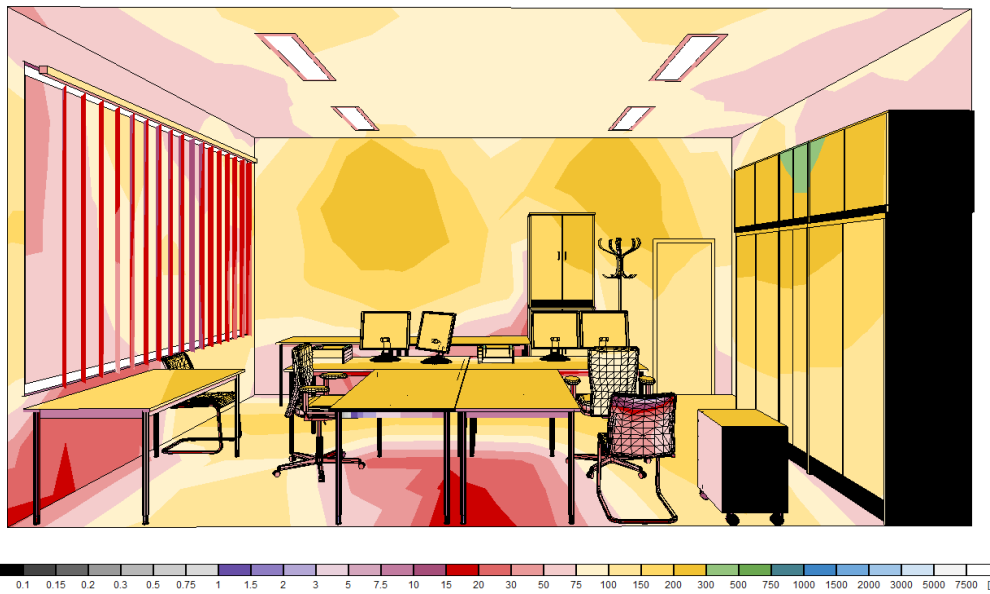
After inspection, the entire lamp was turned off (not just the defective circuit) because the connecting conductors had insulation damage, as shown in Fig. 7. The location of the defective lamp in the office is shown in Fig. 9., and the affected lamp itself is highlighted by a red ellipse.



**Fig. 9.** The location of the faulty lamp in the office

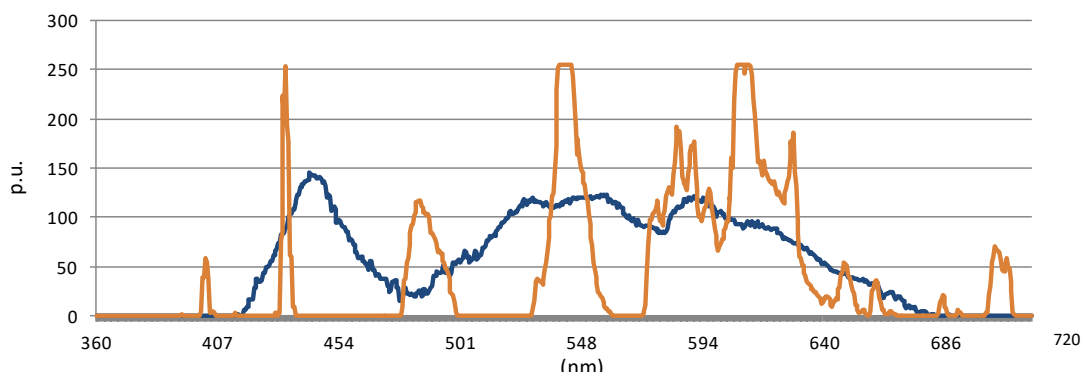
Before the lighting system was put into operation, it was necessary to plan corrective actions. The process begins with analyzing the initial condition by modeling the office space in RELUX program support and determining the lighting parameters, i.e., how they meet the requirements of the standard EN 12464-1:2021 Light and lighting - Lighting of work places -

Part 1: Indoor work places. Fig. 10. shows the situation where lighting levels on work surfaces do not exceed 300 lx. It was clear that simply replacing lamps was not the optimal solution.



**Fig. 10.** Analysis of the initial conditions assuming that all lighting fixtures are in operation

The main problems of the existing system are the replacement and disposal of the FLU tubes every five years, the higher power consumption compared to today's affordable LED lighting and, above all, the impossibility of predicting the life of the remaining ballasts, which are 28 years old. Another benefit of replacing FLU with LED is seen in the potential reduction of the characteristic 100 Hz flicker of FLU, but also in the significant increase in color rendering index due to the richer spectral composition of the LED source. In Fig. 11., the spectral composition of the LED illumination is represented by a blue curve, while the spectrum of the FLU illumination is represented by an orange curve [5]. The spectrometer used for the analysis of light sources for the purpose of this paper is SPECTRA 1, manufactured by Kvant [6].



**Fig. 11.** Comparison of the spectral composition of LED (blue) and FLU light source (orange)

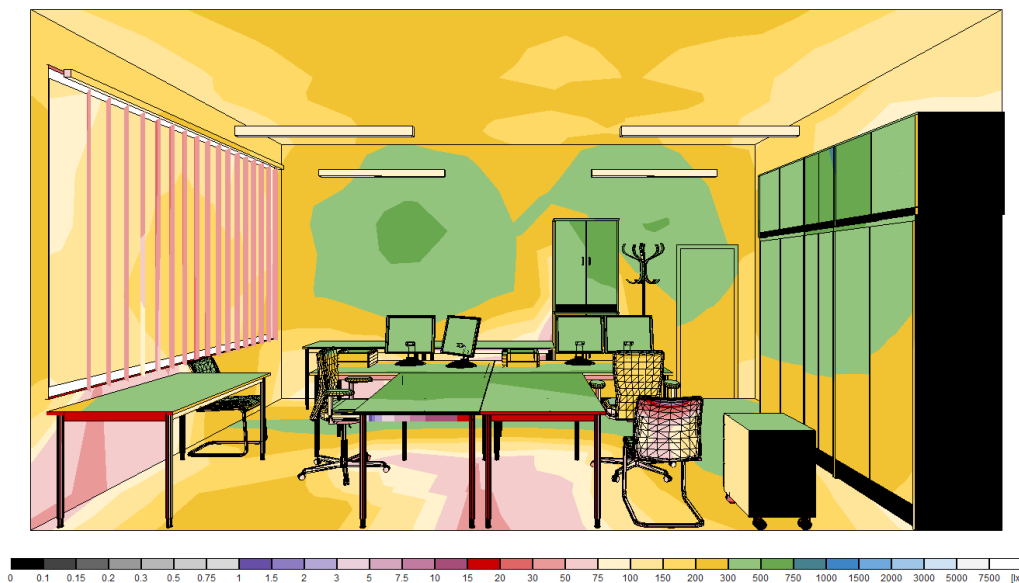
### Modeling of a new LED lighting system

The development of the new system was preceded by an analysis of the currently available sources in the Osijek area. Considering the fact that in the LED technology 85% of the energy is converted into light, while the energy balance from Fig. 1. gives information about the efficiency of the source FLU of 27%, based on the existing installed power per lamp of  $3 \times 36 \Rightarrow 108$  W, we can roughly estimate that the equivalent source LED should be in the

order of 60 W [7]. This does not consider the reduction in luminous flux that results from the useful life of the source. When modeling the initial condition shown in Fig. 10.; the luminous flux per source was 2500 - 3350 lm, which was reduced by the diffuser and the age of the light source. Considering the spectral composition, we decided to make a first analysis with the Schrack lamp Solo LED 1 × 55 W 6000 lm, [8], price 52,17 €. The model of the system with new lamps is shown in Fig. 12., while the illumination values can be seen in Fig. 13.



**Fig. 12.** Lighting system model with new Solo LED 55 W lamps



**Fig. 13.** Results of surface illumination using Solo LED 55 W lamps

The analysis of the data obtained from the simulation shows that the new scene proposal provides values that comply with EN 12464-1:2021 and that the luminous flux of 6000 lm per lamp meets the needs of the users of the room with an illuminance of 500 lx to 750 lx on the work surface.

### Installation of new lamps and lighting measurements

The installation of the new lamps took a little more time because of the arrangement of the sockets and the painting of the ceiling. Fig. 14. shows the ceiling immediately after installation. The installed power was reduced from 456 W ( $4 \times 3 \times 38$  W) to 220 W ( $4 \times 55$  W). If the results of the simulations prove to be good, the tariff model shows that for an investment of 208.68 €, 635.96 kWh can be acquired at current market prices, which, based on an worst case scenario of 2000 working hours per year, gives a simple payback time of

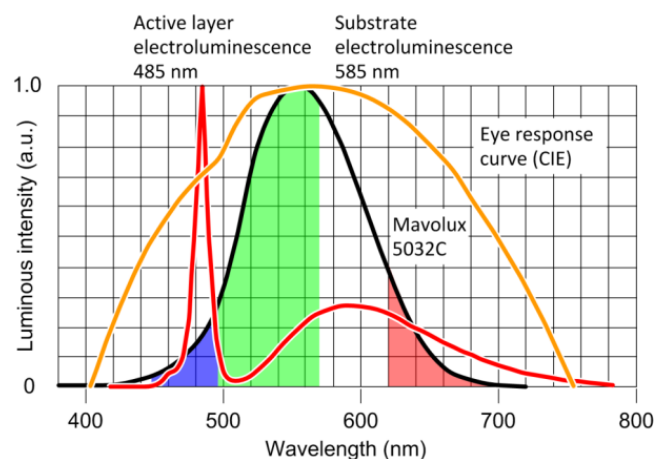


the investment of one year and four months (2695 hours). These figures are very reassuring, since the guarantee on the lamps is two years and the cash flow cannot assume a negative balance.



**Fig. 14.** New LED lighting immediately after installation

The need to make measurements lies in the basic premise of any modeling process, which is that no model is perfect and must be verified by measurement. Fig. 15. shows a comparison of the spectral properties of the human eye, the new light source, and the measurement device used to make the measurements.



**Fig. 15.** Comparison of the spectral response curve of the Mavolux luxmeter (black), the human eye (orange) and the spectrum of the LED white source (red), [9]

Measurements at several points were used to determine the average values on the work surfaces, which ranged from 680 lx to 943 lx [10]. Fig. 16. shows the measured value on the work surface of the table located at the site of the investigated defective lamp FLU.



**Fig. 16.** Verification of model with lighting measurement

## CONCLUSION

Replacing existing light sources with LED technology may not always be a justifiable option from an energy efficiency standpoint. Special care should be taken when replacing FLU light sources because they have relatively high efficiency, long life, and low maintenance costs. When it comes to workplace lighting, the basic requirement is to provide enough illumination for the performance of work tasks. Standard EN 12464-1:2021 defines minimum lighting levels for certain activities. For light sources with many working hours, the energy balance stimulates the use of technology LED. In the practical example presented in the study, the simple payback time of the investment through electricity savings is one year and four months. The analysis carried out did not consider the cost of installation, since it was carried out under exceptional circumstances. It remains an open question whether the mentioned event could have been prevented by regular thermographic inspections. The available thermographic camera with a temperature range up to 150°C proved to be insufficient for the analysis of electrical lighting installations. Before corrective measures are taken or light sources are replaced, calculations should be made to determine the acceptable shapes of lighting fixtures and the distribution of luminous flux. After the modification, it is necessary to confirm the success of the intervention by measurements. Calibrated instruments should be used for measurement, considering their characteristic detection properties.

## REFERENCES

- [1] DiLaura, D. L., Houser, K. W., Mistrick, R. G., Steffy, G. R., Illuminating Engineering Society, The Lighting Handbook, Tenth Edition, 2011, ISBN 978-087995-241-9, USA
- [2] Gibson, K., Incandescent light bulbs to get switched off in 2023 under new Biden rules, CBS NEWS, 27.04.2022. <https://www.cbsnews.com/news/incandescent-light-bulb-phase-out-2023-biden-rule>, accessed 30.04.2023.
- [3] Stokes, G. G., On the change of refrangibility of light, Phil. Trans. 142, 463–562, <https://doi.org/10.1098/rstl.1852.0022>
- [4] EN 12464-1:2021 Light and lighting - Lighting of work places - Part 1: Indoor work places
- [5] Tuđan, M., Kraus, Z., Glavaš, H., Spectral composition of available light sources, Proceedings, 19<sup>th</sup> Natural Gas, Heat and Water Conference, 12<sup>th</sup> International Natural Gas, Heat and Water Conference, Osijek, University of Slavonski Brod, 2021. 48-53.
- [6] Spectrometer Visible Light V4.8 Manual <https://www.forschool.eu/spectrometry/58275-spectra-1-high-resolution-spectrometer.html> , accessed 30.04.2023.
- [7] Stojkov, M., Šljivac, D., Topić, D., Trupinić, K., Alinjak, T., Arsoški, S., Klaić, Z., Kozak D., Energetski učinkovita rasvjeta, Sveučilište Josipa Jurja Strossmayera u Osijeku, Elektrotehnički fakultet Osijek, Strojarski fakultet u Slavonskom Brodu, Osijek, 2015.
- [8] Schrack lighting fixtures - Solo LED 1x55 W 840 6000lm, tehničke specifikacije <https://www.schrack.hr/trgovina/solo-led-1x55W-840-6000lm-1500mm-bijele-b-livi0006.html>, accessed 30.04.2023.
- [9] Glavaš, H., Barić, T., Jukić, D., Desnica, E., Infrared thermography as evaluation method of a faulty status of a LED LCD TV. J Soc Inf Display. 2020; 28: 936– 955. <https://doi.org/10.1002/jsid.951>
- [10] Kočevar, S., Analysis of replacing fluorescent light sources with LED technology, final thesis, undergraduate studies, Faculty of electrical engineering, computer science and information technology Osijek, 2023.



## ANALYSIS OF THE PRODUCTIVITY OF PERFORMING ENERGY RENOVATION WORKS

**Silva Lozančić<sup>1</sup>, Držislav Vidaković<sup>1</sup>, Naida Ademović<sup>2</sup>,  
Marijana Hadzima-Nyarko<sup>1</sup>**

<sup>1</sup>Josip Juraj Strossmayer University of Osijek, Faculty of Civil Engineering and Architecture Osijek, Osijek, Croatia

<sup>2</sup> University of Sarajevo-Faculty of Civil Engineering, Sarajevo, Bosnia and Herzegovina

e-mail: [lozancic@gfos.hr](mailto:lozancic@gfos.hr); [dvidak@gfos.hr](mailto:dvidak@gfos.hr); [naidadem@gmail.com](mailto:naidadem@gmail.com); [mhadzima@gfos.hr](mailto:mhadzima@gfos.hr)

**Abstract:** In recent times, energy renovation projects for private and public buildings have been prominent. They are necessary to reduce losses and energy consumption, but their implementation also requires energy, which is consumed more if the work lasts longer.

The article analyzes the specifics of the performance of energy renovation projects that are important for productivity, and thus also for the duration and costs of the works. The lack of appropriate time norms and the neglect of the necessary auxiliary works were pointed out. That is why it is necessary to look at how working time is spent, and this can be done using activity monitoring techniques, for which examples are shown. Based on the analysis of the conditions for the implementation of these projects, the review of the literature, and the examination of experts, the factors that influence the stalls and delays in the implementation of energy renovation projects have been defined. According to the observed problems and experiences from foreign studies, measures were proposed to achieve higher productivity and better planning of the work.

**Key words:** energy renovation, work productivity, impacts, deadline, delay, improvement

### INTRODUCTION

In developed countries, construction and other works are mainly carried out on the renovation and maintenance of existing buildings, and lately, there have been very frequent projects of energy renovation of private and public buildings. It is known that the highest energy consumption is in buildings, which in Croatia is 42.3% of the total energy, and almost two-thirds of that is for heating [1]. Therefore, there is a great potential for energy savings in the existing stock of residential and public buildings. In Croatia, this particularly refers to improving the energy efficiency of 1.42 million inhabited apartments and houses, of which 54% are detached houses, and 46% are houses with more than one apartment. 75% of them are older than 20 years, and many are more than 50 years old, which means that they were built according to much weaker energy efficiency standards than the current enforced standards, so they are mostly rated as E or F energy class [1].

Reducing energy consumption is of general interest, and measures to reduce consumption are largely co-financed from national and European funds. This significantly shortens the payback time for owners' investments in energy renovation, generating great interest in this regard [2]. That is why in recent years, a large number of such projects have been initiated, mostly focused on reducing heating energy [3, 4].

The problem is that in tenders, the lowest bids often exceed the projected financial resources, and during the implementation of energy and other related building renovation projects, the planned deadline and costs are frequently exceeded. This occurs due to poor productivity and inadequate planning. The determination of costs and the timeframe directly result from the planned productivity of the contractors, which is influenced by several different factors. The difference between planned and actual productivity can lead to inappropriate resource allocation and lower productivity than the planned one can result in exceedance of the contracted implementation deadline. Weak productivity of project contractors not only negatively impacts the profitability of their business and their business



reputation but is also detrimental to investors and, ultimately, to the overall economy and the state.

## CHARACTERISTICS OF IMPLEMENTATION OF ENERGY RENOVATION PROJECTS

Energy renovation measures mostly require construction and other works on existing buildings for [2, 3, 4]:

- improving the thermal protection of the building's outer envelope (installation of high-quality thermal insulation and energy-efficient joinery),
- increasing the efficiency of the lighting system and electrical devices,
- improvement of the building's technical systems (heating, cooling, ventilation, air conditioning, preparation of usage of domestic hot water, lighting system, building automation and management system, introduction of renewable energy sources) and
- use of renewable energy sources (e.g., change of energy source – transition from heating oil to wood biomass, installation of solar panels, etc.).

Energy efficiency projects should strive for a complete overview of the possibility of increasing energy efficiency and choosing a concept that will ensure the greatest savings with an appreciable return on investment time [5]. Integral energy renovation is a combination of several energy renovation measures, with mandatory improvement of the thermal protection of the building envelope. With a larger share of co-financing of the works, an in-depth and comprehensive renovation is sought to be encouraged, which, in addition to energy renovation, includes earthquake and fire protection measures, and it is desirable to ensure healthy indoor climate conditions, enable accessibility for people with reduced mobility, install elements of green infrastructure, etc. [2]. Energy renovation can also be related to the reconstruction of the building, such as its change of usage.

Fig. 1. shows typical construction sites where energy renovation projects are implemented in Croatia.



**Fig. 1.** Typical energy renovation construction sites - work on the external thermal envelope of family houses and apartment buildings[6, 7]

In relation to recent construction, the implementation of energy renovation projects has some pronounced specificities. Now that there is a distinct lack of qualified construction workers in Croatia, these projects must require a large proportion of the work to be performed by workers only (the possibility of mechanization of these work processes is weak). The problems that are often emphasized, whether it is only about energy renovation or a more comprehensive renovation of buildings, i.e., measures to improve various basic building requirements are [8, 9, 10, 11]:

- an existing building structure with several unknown characteristics (e.g., types and quality of installed materials and their wear and tear), which may be the reason for subsequent requests for unplanned works,
- tasks that require specialized workers of certain professions and qualifications,
- less amount of work,

- suboptimal layout of the construction site for logistics and material manipulation,
- less accessible and cramped workspace,
- frequent execution of works on buildings that are in use (tenants and other users of the space), and
- contractors are mostly small or medium-sized companies.

Cost estimates are often not aligned with the main project, so during and after construction, explanations of extra-budgetary works are needed, in order to justify what was actually performed and installed, and so that the owner is satisfied with the co-financed participation at the end of the project. Also, during construction, additional requests from investors, i.e., owners, appear, which change the contractors' planned activities and further complicate the execution of the project [12].

To perform productive work (according to Lean terminology, Value-Adding activities), it is necessary to perform several auxiliary, semi-productive activities such as:

- arriving at the work site within the construction site (e.g., on the floor or roof),
- preparation and organization of the workplace,
- giving and receiving instructions, reading drawings,
- taking tools and materials, unpacking materials,
- cutting or mixing some materials,
- setting up/arranging a machine or tool, setting up and moving scaffolding and ladders,
- assisting in the performance of direct work (positioning, supporting, etc.),
- marking, control of the conducted work (measurement, etc. inspection),
- cleaning tools and other work equipment,
- waste removal,
- safety procedures at work (e.g., when working at height or in confined, hard-to-reach spaces), etc.

The need for such works must never be neglected when planning manpower, equipment, time, and costs. Although auxiliary activities consume resources, they are usually not directly included in the budget items. Given that they are not precisely specified in the cost estimate, it often happens that their execution becomes a subject of dispute between the contractor and the investor due to requests for additional payment.

## **PRODUCTIVITY OF ENERGY RENEWAL WORKS**

### **Measurement of the use of working time**

The duration of the activity or the number of workers/machines (when there is a given deadline) and direct costs should be calculated using time norms, but all energy renovation works foreseen by the project are not covered by the existing general, public norms. Manufacturers of materials generally provide good data for the consumption of their materials per unit measure, but not for the hours worked by workers, and especially not for auxiliary work.

Time standards generally provide for 40-60% of the production time, and for preparatory-final and auxiliary works 25-35% of the total time worked. According to 474 case studies over 50 years in different countries Wandahl et al. (2021) determined that, on average, the time spent on billable activities (production time) accounts for only 43.6% of the total working time [13]. In order to plan costs and project durations with a higher level of reliability (neither overestimating nor underestimating), it is necessary to determine the achieved work productivity and the amount of lost time by the contractors for specific types of tasks. For this purpose, various methods are very suitable (and can be combined and adapted as needed) [14].

- Work sampling (activity)

- Five-minute rating
- Method Productivity Delay Model (MPDM)
- Field Surveys - Foreman delay survey and Craftsman questionnaire.

Work sampling on a large block renovation project in Denmark initially (before improvement measures) showed the proportions of time spent as listed in Table 1.

**Table 1.** The structure of time consumption determined by the initial sampling of works on the renovation project of blocks of residential buildings in Denmark (according to [15])

Productive work 26.0%	Semi-productive work 44.4%		Useless wasted time 29.6%	
	Talks about work (instructions etc.) – 20.9%		Unnecessary walking– 6.3%	
	Preparation – 15.7%		Waiting – 6.6%	
	Transports– 7.7%		Absence from the workplace – 16.6%	

As a good indicator of performance, from such data Labour Utilisation Factor (LUF) can be determined according to the expression [16]:

$$LUF = \frac{\text{Productive work (observed)} + 0,25 \times \text{Auxiliary work (observed)}}{\text{Total working time (total number of observations)}} \quad (1)$$

In general, it is considered satisfactory when the LUF is > 50% [17]. However, in some cases, the auxiliary work is multiplied by 0.33, and sometimes even up to 1.00.

Wandahl et al. (2022) on the renovation of 24 multi-apartment buildings by sampling the work of 40 workers on replacing windows and roofs and installing new ventilation and electrical systems determined the average share of direct work was 25%, auxiliary work was 53% and lost time 22% [18].

According to international studies and the monitoring of works in Croatia, the most pronounced losses of working time on such projects were observed:

- in the unjustified absence from the workplace (being late, leaving early, unplanned breaks),
- not working/idleness and loafing (chatting, playing with a mobile phone, smoking, etc.),
- in waiting (for work instructions, for material, equipment, and other workers, conditioned by congestion of the workspace),
- unnecessary work (e.g., searching for materials and tools, repairs of unprofessionally done work, or additional work due to bad material) and unnecessary or excessively long movement.

Fig. 2 - 4 show examples of 5-minute productivity assessments on three building energy renovation projects in Croatia during various types of work. In Figure 2, the results of monitoring four workers during scaffold assembly on the building facade were obtained through a rough estimation of productivity using a 5-minute assessment. According to these results, the calculated share of productive and semi-productive time (useful work) is 67.9 – 85.7%

Time	Worker 1	Worker 2	Worker 3	Worker 4	
9:00	x	x	-	-	Total observations (n) : 28 Useful work (X) : 24 (85.7%) Not working (-) : 4 (14.3%) (they smoke, stand and watch)
9:05	x	x	x	-	
9:10	x	x	x	-	
9:15	x	x	x	x	
9:20	x	x	x	x	
9:25	x	x	x	x	
9:30	x	x	x	x	

Time	Worker 1	Worker 2	Worker 3	Worker 4	
11:00	-	x	-	x	Total observations (n) : 28 Useful work (X) : 19 (67.9%) Not working (-) : 9 (32.1%) (they smoke, stand and watch, not at work)
11:05	-	x	x	x	
11:10	x	-	-	-	
11:15	x	-	-	-	
11:20	x	x	x	x	
11:25	-	x	x	x	
11:30	x	x	x	x	

**Fig. 2.** An example of evaluating the level of useful work on scaffolding assembly

Figures 3 and 4 show 5-minute rating patterns with a more detailed breakdown of worker time records (from which LUF can be calculated) on works that are very common in energy renovation.

Time	Skilled Worker (with the machine)	Semi-skilled Worker	Semi-skilled Worker	
14:20	E Applies plaster	C Brings the mixture and puts it in the machine	E Aligns with the batten	Total observations (n) : 21
14:25	E Applies plaster	C Brings the mixture and puts it in the machine	E Aligns with the batten	Activities that create added value (E) : 8 (38.1%)
14:30	E Applies plaster	C Brings the mixture and puts it in the machine	E Aligns with the batten	Additional activities required (C) : 7 (33.3%)
14:35	E Applies plaster	C Brings the mixture and puts it in the machine	E Aligns with the batten	Useless time (NP) : 6 (28.6%)
14:40	NP Resting	NP Resting	NP Resting	Productive work
14:45	NP Resting	NP Resting	NP Resting	I. $(\sum E + 0.25 \times \sum C) / n = (8 + 0.25 \times 7) / 21 = 46.4\%$
14:50	C Cleaning the workspace	C Cleaning the workspace	C Cleaning the workspace	II. $(\sum E + 0.75 \times \sum C) / n = (8 + 0.75 \times 7) / 21 = 63.1\%$

**Fig. 3.** An example of a 5-minute evaluation of the level of productivity of facade wall plastering during the energy renovation of a school building

Time	Worker 1	Worker 2	Worker 3	
9:00	E Applies glue on the surface	C Unpacks and stacks on the scaffolding	C Mixes the glue	Total observations (n) : 18
9:10	E Glues the board to the wall	C Goes to get a new package of wool	C Lifts the glue on the scaffolding	Activities that create added value (E) : 4 (22.2%)
9:20	C Aligns and controls	NP Stayed	C Mixes the glue	Additional activities required (C) : 12 (66.7%)
9:30	E Applies glue on the surface	C Lifts the package onto the scaffolding	C Lifts the glue on the scaffolding	Useless time (NP) : 2 (11.1%)
9:40	E Glues the board to the wall	C Unpacks and stacks on scaffolding	C Went to get a bag of glue	Productive work
9:50	C Aligns and controls	C Goes to get a new package of wool	NP Stayed	I. $(\sum E + 0.25 \times \sum C) / n = (4 + 0.25 \times 12) / 18 = 38.9\%$
				II. $(\sum E + 0.75 \times \sum C) / n = (4 + 0.75 \times 12) / 18 = 72.1\%$

**Fig. 4.** An example of a 5-minute evaluation of the level of productivity of workers covering the facade wall of a hotel with mineral wool [11]

### Variable impacts on productivity

The productivity of contractors in the implementation of construction projects differs significantly depending on the task and working conditions [19], and it also differs in general for works on single-family houses and apartment buildings [20]. More extensive studies, as well as the examples given here, show the difference in the measurement results for different:

- contractors (workers of different qualities, differently motivated and guided by management, etc.),
- construction sites/workplaces (height and space for work, the possibility of delivery and storage of materials, etc.)
- projects/types of works (different complexity of performance and quality requirements), and
- observation time.

During the execution of an energy renovation project, the dominant aspect is the actual performance of the work by the workers, making their characteristics especially important, such as experience in construction, dexterity, physical strength, and morale [21]. However, the most significant influence on productivity often lies within the contractor's management domain, encompassing preparation, logistics, site organization, and management (work planning, material and equipment selection and procurement, work methods, coordination of workgroups and subcontractors, worker supervision, instructions, etc.). Additionally, identified as important factors that can negatively impact productivity are:

- project documentation (shortcomings and changes to drawings and specifications during the execution of works),
- unforeseen conditions on the construction site/existing building,

- unusually unfavorable weather conditions,
- the state of the material market (shortage, price increase), and
- dynamics of payment for works (delay).

In order to better determine measures to avoid such problems or at least reduce the negative impact on productivity, it is necessary to investigate them and determine their order of importance.

### Impacts of labor productivity on the delay of energy renovation projects

The duration of the work is the quantity (amount) divided by the collective output of the workers (in terms of the amount of work they perform in one hour), and the cost per unit of work is the cost of an hour of work divided by the hourly output. When there is poor work productivity in activities critical to the project's implementation, their extension leads to exceeding the planned deadline. Therefore, work productivity itself, along with the same factors influencing productivity, is often considered as factors affecting the exceeding of planned costs and the planned implementation deadline. Based on a review of the literature and semi-structured interviews with experts in this field, factors leading to delays and project extension in energy renovation projects have been defined. They are categorized into groups based on responsibility or controllability and listed in Table 2.

**Table 2.** Groups of factors that influence delays and prolongation of energy renovation projects

<b>Force majeure</b>	<b>Investor / Owner and designer</b>	<b>Contractor(s)</b>
Aggravating weather conditions Market problems (material shortage, large price changes, etc.)	Problems with building owners, Non-payment / Irregular payment of the contractor, Errors and shortcomings of project documentation Different conditions than those foreseen by the project (require unforeseen works) Project changes during implementation by the designer and investor	Poor planning (or work without a plan) and an unrealistic agreed deadline Poorly organized construction site (scheduling, landfills, etc.) Cramped - congested workspace Lack of materials on the construction site Lack of appropriate tools and equipment for work Lack of workers at the construction site Weak skills of workers Indiscipline of workers - bad use of working time Weak instructions and insufficient control of workers' work

The next step in the research involves surveying experts in this field, aiming to determine the rank of importance of the defined factors for the extension of energy renovation project implementation. This assessment will consider both the strength of their impact and, particularly, their frequency.

### FINAL RECOMMENDATIONS FOR IMPROVING ENERGY RENOVATION PLANNING AND IMPLEMENTATION

Costs and time need to be considered even before the commencement of the works. Research and analysis indicate that exceeding the planned deadline and cost often occurs due to their unrealistically defined parameters, which directly result from the assessment of the contractor's work productivity. When planning time and costs, the characteristics of the project and all necessary works should be taken into account, rather than focusing solely on value-added activities. In addition to non-productive time, it is advisable to minimize auxiliary

work as much as possible without disrupting the performance of productive activities. This can be achieved through modern work technologies and better work organization.

For a successful improvement in productivity, timely detection of negative impacts is necessary, and ideally, their prediction and prevention. To monitor the progress and collect data for future projects, a productivity monitoring system should be implemented that is simple and easily understandable, beneficial at various organizational levels, has appropriately structured databases, and allows tracking over time [22]. Based on continuously collected data, contractors can systematically analyze costs and optimize time schedules. Understanding the importance of negative influences on work productivity helps determine suitable measures for increasing productivity. These measures can lower implementation costs and reduce the need for a workforce, which is particularly crucial during labor shortages.

Previous studies (e.g., [15]) have found that the application of Lean principles significantly increases the share of productive work in building renovation projects. Lean techniques [23] can be suitable for such projects:

- Gemba (walk, i.e., site visit): Problems are identified and solved where they occur, in collaboration with those directly involved in the work process.
- 5 S (material storage and workspace arrangement) - Changing employees' awareness of the work environment through sorting and discarding all unwanted, unnecessary items from the workplace, establishing order and optimal arrangement, regular cleaning, standardization, and maintaining behaviors.
- Last Planner System - Through the main plan and detailed planning, contractors, and subcontractors specify the work to be done and determine which phase of the project must be completed before the start of the next phase, which is then linked to material delivery. ("Last planners" regularly monitor the percentage of completion and the prepared tasks that follow.)

In addition to its significant importance in achieving the main goals of project implementation, improved work productivity of contractors, leading to savings in required labor and time, contributes to lower energy consumption and CO<sub>2</sub> emissions. For example, by shortening the implementation time, less energy is consumed for transporting workers, operating machinery at the construction site, lighting, and heating/cooling the premises at the construction site, and more.

## REFERENCES

- [1] Internet source: Ušteda energije u građevinama, Nacionalni portal energetske učinkovitosti: <https://www.enu.hr/gradani/info-edu/usteda-energije-u-zgradama/>
- [2] Bogdan, A., Za energetska obnovu osigurano 225 milijuna eura, *Građevinar*, Vol. 75, No.3, pp. 299 – 301, 2023.
- [3] Vidaković, D., Lozančić S., Hadzima-Nyarko, M., Krajnović, M., Energy renovation of school buildings in Osijek-Baranja county, *Proceedings of the XI International Conference Industrial Engineering And Environmental Protection 2021, Zrenjanin, 2021.*, pp. 6 – 14.
- [4] Hećimović, D., Vidaković, D., Analyses cost effectiveness energy reconstruction family houses in Osijek-Baranya county, *Proceedings of the 27th International Scientific and Professional Conference Organization and Maintenance Technology, Osijek, 2018.*, pp. 97 – 104.
- [5] Hrs Borković, Ž., Primjeri dobre prakse u provedbi energetske obnve zgrada, *Presentation of the workshop "Kako planirati, financirati i voditi projekte s integracijom mjera energetske učinkovitosti u urbanoj obnovi – Perspektiva gradova"*, Osijek, 2017.
- [6] Internet source: Karalić, Đ., Energetska obnova obiteljskih kuća već u ožujku, *PRESS/032*, 2020., <https://press032.com/energetska-obnova-obiteljskih-kuca-vec-u-ozujku/>

- [7] Internet source: Početkom 2020. novi natječaj za energetska obnovu višestambenih zgrada, Rijeka stan, 2020, [https://www.rijekastan.hr/hr/pocetkom\\_2020\\_novi\\_natjecaj\\_za\\_energetsku\\_obnovu\\_visestambenih\\_zgrada/88/2](https://www.rijekastan.hr/hr/pocetkom_2020_novi_natjecaj_za_energetsku_obnovu_visestambenih_zgrada/88/2)
- [8] Kemmer, S., Development of a Method for Construction Management in Refurbishment Projects, PhD thesis, University of Huddersfield, 2018.
- [9] Neve, H.H., Wandahl, S., Lindhard, S., Teizer, J., Lerche, J., Learning to see value-adding and non-valueadding work time in renovation production systems, Production Planning and Control (e-journal), 2020.
- [10] Tzortzopoulos, P., Kagioglou, M., Koskela, L., Lean Construction – Core Concepts and New Frontiers, Routledge, London and New York, 2020.
- [11] Vidaković, D., Hećimović, D., Završki, P., Assessment of productivity and support works on energy renovation projects, Presentation of the 16. Dani Hrvatske komore inženjera građevinarstva, Theme: Energy renovation of buildings – comprehensive renovation of buildings, Opatija, 2022.
- [12] Matotek, R., Energetska obnova kroz EU projekte, Građevinar, Vol. 75, No.2, pp. 203 – 205, 2023.
- [13] Wandahl, S., Pérez, C.T., Salling, S., Neve, H.H., Lerche, J., Petersen, S., The Impact of Construction Labour Productivity on the Renovation Wave, Construction Economics and Building Vol. 21, No.3, pp. 11 – 32, 2021.
- [14] Dozzi, S.P., Abourizk, S.M., Productivity in Construction, Construction Engineering and Management Civil Engineering Department University of Alberta, Institute for Research in Construction, National Research Council Canada -37001, Ottawa, 1993.
- [15] Johansen, P., Christensen, S., Neve, H.H., Wandahl, S., Lean renovation – a case study of productivity, flow, and time improvements, Proceedings of the 29th Annual Conference of the International Group for Lean Construction, Lima, 2021, pp. 839 – 848.
- [16] Oglesby C.H., Parker H.W., Howell G.A., Productivity Improvement in Construction, McGraw-Hill, 1989.
- [17] Oktafia, R., Muhammad I., Analisa produktivitas Tenaga Kerja Pada Pekerjaan Struktur Atap Baja Ringan, Jelast: Journal of PWK, Sea, Civil, Mining, Vol. 5, No.3, pp. 1 – 10, 2018.
- [18] Wandahl, S., Pérez, C. T., Salling, S., Lerche, J., Robustness of Work Sampling for Measuring Time Waste, Proceedings of the 30th Annual Conference of the International Group for Lean Construction, Edmonton, 2022, pp. 247 – 258.
- [19] Chang, S., Yi, J. S., Son, J., The productivity improvement for steel framing work efficiency by work sampling and 5-minute rating technique, Journal of Construction Engineering Project Management, Vol. 5, No.1, pp. 40 – 46, 2015.
- [20] Sveikauskas, L., Rowe, S., Mildenerger, J., Price, J., Young, A., Productivity Growth in Construction, Journal Construction Engineering Management, Vol. 142, No.10, pp. 04016045-1 – 04016045-8, 2016.
- [21] Vidaković, D., Hadzima-Nyarko, M., Marenjak, S., The Contribution of Workers' Attributes on Sustainability of Construction Project Realization Goals – Survey on the Impact on Productivity in Croatia, Sustainability Issues in Civil Engineering and Management, Sustainability, Vol. 12, No.23, pp. 9946, 2020.
- [22] Lim, E. C., The analysis of productivity in building construction, PhD thesis, Loughborough University, 1996
- [23] Vidaković, D., Lacković, Z., Radman-Funarić, M., Improving realization of construction works applying Lean methodology, Proceedings of the 8th International Natural Gas, Heat and Water Conference / 15. skup o prirodnom plinu, toplini i vodi PLIN 2017, Osijek, 2017, pp. 335 – 346.

# **Oral/Poster Presentation**





**XIII International Conference Industrial  
Engineering and Environmental  
Protection 2023 (IIZS 2023)  
October 05-06, 2023, Zrenjanin, Serbia**

---

# **Session 1**

# **Mechanical Engineering**



## OUT OF PLANE VIBRATIONS OF CRACKED CURVED PIPES CONVEYING FLUID

Dimitar Lolov<sup>1</sup>, Svetlana Lilkova-Markova<sup>2</sup>

<sup>1</sup>University of Architecture, Civil Engineering and Geodesy, Faculty of Hydraulic Engineering, Sofia, Bulgaria  
e-mail: [dlolov@yahoo.com](mailto:dlolov@yahoo.com)

<sup>2</sup>University of Architecture, Civil Engineering and Geodesy, Faculty of Hydraulic Engineering, Sofia, Bulgaria  
e-mail: [lilkova\\_fhe@uacg.bg](mailto:lilkova_fhe@uacg.bg)

**Abstract:** A cracked curved pipe bent in the arc of a circle conveying fluid is investigated. The flowing fluid is considered as a non-compressible and heavy. The considered pipe is assumed cantilevered at its both ends. The Galerkin method is employed to approach numerically the problem and to investigate the dynamic out of plane stability of the pipe. The obtained numerical results show the dependence of the critical fluid velocity on the maximal central angle of the pipe axis.

**Key words:** curved pipe, fluid, circular frequency, flow velocity

### INTRODUCTION

The straight and curved pipes conveying fluid are used in various fields of engineering. The vibrations of these tubes are an important topic for research.

The paper of Svetlitsky, V. [1] is one of the first works about the stability of curved pipes conveying fluid. Jung and Chung [2] apply Hamilton's principle to obtain the equations describing the in- and out-of-plane vibrations of extensible curved pipes. The Galerkin method is used to solve them.

Dupuis C. and Rousselet J. [3] have investigated curved fluid conveying pipes. The pipe was treated as a Timoshenko's beam and the fluid was considered incompressible. Zhao Q. and Sun Z. [4] have used the new transfer matrix method to analyze the in-plane vibrations of pipes conveying fluid. The critical velocity of the fluid and the natural frequency of the system are calculated.

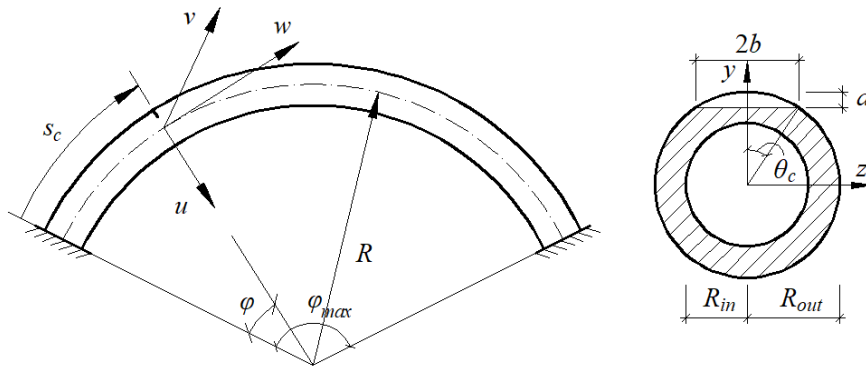
Cracks are the most encountered damages in the structures. They reduce the stiffness of the structural element which causes decrease in its natural frequencies and change in the mode shapes. In pipes conveying fluid, cracks lead to decrease in the critical flow velocity. The cracks could be hazardous for the system. They might lead to loss of stability if the reduced, due to the crack, critical velocity of the transported fluid is exceeded. That's why crack detection is a topic of much interest in the scientific community. Some of the studies for crack detection deal with change in the natural frequencies and eigenforms, other with dynamic response to harmonic loads.

The present paper investigates the out-of-plane dynamic stability of a cracked curved pipe, conveying fluid. The results obtained reflect the dependence of the critical fluid velocity on the central angle of the pipe. The results also show the effect of an open crack on the critical velocity of the fluid.

### OUT-OF PLANE VIBRATION OF CURVED PIPE CONVEYING FLUID

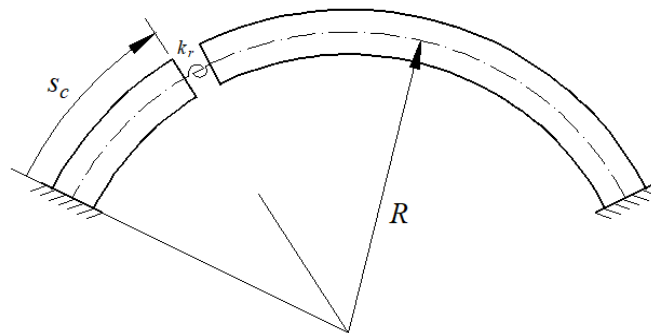
The present paper investigates the out of plane stability of cracked curved pipes, conveying fluid. The static scheme of the pipe under consideration is shown in Fig. 1. The pipe is bent in the form of an arc of a circle with radius  $R$ . The material of the pipe is linear elastic with Young's modulus  $E$  and shear modulus  $G$ . The cross-sectional parameters are area  $A$ , axis

moment of inertia  $I$  and polar moment of inertia  $I_c$ . The fluid flowing in the pipe is heavy and non-compressible.  $v$  is the out of plane displacement. The pipe is supposed to have an open edge crack, which dimensions ( $\theta_c$  and  $b$ ) are shown in (Fig.1).  $b$  is the length of the crack.  $\theta_c$  is the half central angle corresponding to the chord  $b$ . The crack severity is usually measured by the ratio  $\theta_c / \pi$ . The crack position along the length of the tube is fixed through the curvilinear coordinate  $s_c$ . The crack is modeled as a rotational spring with a lumped stiffness  $k_r$  [5] (Fig.2).



**Fig. 1.** Static schemes of the investigated pipe conveying fluid

The pipe is divided into two segments. The first segment is the left-hand side of the crack, and the second – is the right-hand side of the crack.



**Fig. 2.** Mechanical model of the crack

The differential equation of the free out of plane vibrations of the pipe, shown in [6], is

$$EI \frac{\partial^4 v}{\partial s^4} + \left( m_f V^2 - \frac{GI_c}{R^2} \right) \frac{\partial^2 v}{\partial s^2} + 2m_f V \frac{\partial^2 v}{\partial s \partial t} + (m_f + m_p) \frac{\partial^2 v}{\partial t^2} = 0 \quad (1)$$

Here  $s$  is the curvilinear coordinate,  $t$  – the time. The mass of the pipe per unit length is denoted by  $m_p$ , the mass of the fluid per unit length of the pipe by  $m_f$ .  $V$  is the flow velocity of the fluid in the pipe.

The spectral Galerkin method is applied to approximate the solution of the boundary value problem (1). According to this method, an approximate solution is sought in the form

$$v(s, t) = \sum_{i=1}^n y_i(s) z_i(t) \quad (2)$$

where:

$z_i(t)$  - are unknown functions;

$y_i(x)$  - are basic functions that satisfy the boundary conditions of the pipe. Such functions are the functions describing the  $i$ -th mode of vibration of a beam with the same static scheme as the pipe.

After a discretization on the basis of the matrix method, described in [7], the following system of equations is obtained

$$|M|\ddot{z} + |K|z = 0 \quad (3)$$

The pipe is divided to sections with length  $\Delta s$ . The elements of the matrices  $M$  and  $K$  are given by:

$$M_{ik} = (m_f + m_p)\{y_i\}^T\{y_k\}\Delta s, \quad M_{ik} = 0 \text{ (when } i \neq k) \quad (4)$$

$$K_{ik} = \frac{1}{EI} \left( \frac{GI_c}{R^2} - m_f V^2 \right) \{M_i\}^T \{y_k\} \Delta x + E_{ik} \quad (5)$$

$$E_{ik} = \Delta s (m_f + m_p) \omega_i^2 \quad E_{ik} = 0 \text{ (when } i \neq k) \quad (6)$$

where in (4),(5) and (6):

$\omega_i$  is the circular frequency of the pipe, filled with stationary fluid ( $V = 0$ );

$\{y_i\}$  is a column vector consisting of the out of plane displacements of the stations on the axis of the pipe, corresponding to the  $i$ -th eigen form in the case of pipe filled with stationary fluid ( $V = 0$ );

$\{M_i\}$  is a column vector consisting of the bending moments in the stations on the axis of the pipe, corresponding to the  $i$ -th eigen form in the case of pipe filled with stationary fluid ( $V = 0$ )

The general solution of the system (3) is expressed through the roots ( $\lambda_1 \dots \lambda_{2n}$ ) of the equation

$$\det X = 0 \quad (7)$$

The elements of the matrix  $X$  are given by:

$$X_{ik} = \lambda^2 M_{ik} + K_{ik} \quad (8)$$

On the basis of obtained roots ( $\lambda_1, \dots, \lambda_{2n}$ ) could be drawn conclusions about the stability of the system. The system is stable if the real part of all the roots of the characteristic equation (7) is negative.

The roots ( $\lambda_1, \dots, \lambda_{2n}$ ) depend on all the parameters of the system. If all of them are fixed except the velocity of the conveyed fluid  $V$ , one could obtain the corresponding critical velocity.

## CRACK MODELING

The crack is assumed to be open. Castigliano's theorem is used to obtain the local flexibility in the presence of the crack [8]

$$c = \frac{\partial^2 U}{\partial M^2} = \frac{1-v^2}{E} \int_{-b}^b \int_0^a \frac{\partial^2 (K_I^2)}{\partial M^2} dy dz \quad (9)$$

where  $E$  and  $\nu$  are respectively Young's module and Poisson's ratio.  $K_I$  is the stress intensity factor of bending.  $a$  and  $b$  are the crack dimensions as shown in (Fig.1).  $M$  is the bending moment.

$$K_I = \frac{M}{\pi R^2 t_p} \sqrt{\pi R \theta_c} F(\theta_c) \quad (10)$$

where  $R = 0,5(R_{in} + R_{out})$ ,  $t_p$  and  $\theta_c$  are respectively thickness of the pipe and the half central angle of the crack (Fig.1).  $F(\theta_c)$  is calculated from the following formula [9]

$$F(\theta_c) = 1 + A_t \left[ 4,5967 \left( \frac{\theta_c}{\pi} \right)^{1,5} + 2,6422 \left( \frac{\theta_c}{\pi} \right)^{4,24} \right] \quad (11)$$

$$A_t = \sqrt[4]{\frac{1}{8} \frac{R}{t_p} - \frac{1}{4}} \quad \text{for } 5 \leq \frac{R}{t_p} \leq 10 \quad (12)$$

$$A_t = \sqrt[4]{\frac{2}{5} \frac{R}{t_p} - 3} \quad \text{for } 10 \leq \frac{R}{t_p} \leq 20. \quad (13)$$

The equivalent rotational spring stiffness

$$k_r = \frac{1}{c} \quad (14)$$

## RESULTS AND DISCUSSION

Numerical studies have been carried out for the system in Fig. 1.

The geometric and the material characteristics of the pipe are: the inner and the outer radii of the cross-section of the pipe are  $R_{in} = 0.012m$  and  $R_{out} = 0.014m$ , Young's modulus  $E = 210GPa$ , shear modulus  $G = 80GPa$ , the density of the material of the pipe  $\rho = 7800kg/m^3$

The density of the flowing fluid in the pipe is  $\rho_f = 1000kg/m^3$ .

The dimensions of the crack are  $a = 0.001m$ ,  $b = 0.005m$ . The position of the crack is fixed with the coordinate  $s_c = 1,5m$ .

In the present paper 14 eigenfunctions  $y_i(s)$  are used in the approximate solution (2).

For the pipe in Fig.1 is obtained the critical value of the flowing fluid  $V_{cr}$  for different values of  $\varphi_{max}$ . The results are shown in Fig.3. It is obvious that increasing the  $\varphi_{max}$  lowers the critical fluid velocity.

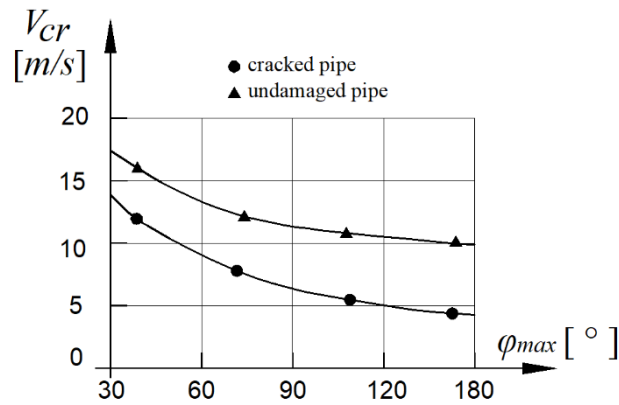


Fig. 3. Dependence of the critical velocity of the system on  $\varphi_{max}$

## CONCLUSION

The results show the dependence of the critical non-dimensional fluid velocity of the system on  $\varphi_{max}$ . Increasing the  $\varphi_{max}$  leads to decrease in the critical velocity.

The crack has a destabilizing effect on the system, leading to decreasing of the critical velocity of the pipe flow.

## REFERENCES

- [1] Svetlitsky, V., Statics, stability and small vibrations of the flexible tubes conveying ideal incompressible fluid, *Raschetv na Prochnost*, Vol.14, pp. 332-351, 1969.
- [2] Jung, D., Chung, J., In-plane and out-of-plane motions of an extensible semi-circular pipe conveying fluid, *Journal of Sound and Vibration*, Vol.311, No.1, pp.408-420, 2008.
- [3] Dupuis, C., Rousselet, J., The equation of motion of curved pipes conveying fluid, *Journal of Sound and Vibration*, Vol. 153, Issue 3, pp. 473-489, 1992.
- [4] Zhao, Q., Sun, Z., Flow-induced vibration of curved pipe conveying fluid by a new transfer matrix method, *Engineering applications of computational applied mechanics*, Vol.12, NO.1, pp. 780-790, 2018.
- [5] Sadettin, O., Analysis of free and forced vibration of a cracked cantilever beam, *NDT&E International*, Vol.40, pp.443-450, 2007.
- [6] Hill, J., Davis, C., The Effect of Initial Forces on the Hydroelastic Vibration and Stability of Planar Curved Tubes, *Journal of Applied Mechanics*, pp.355-359, June 1974.
- [7] Weaver, D., On the dynamic stability of fluid conveying pipes, *Journal of Applied Mechanics*, Vol.40, pp.51-54, 1973.
- [8] Eslami, G., et al, Effect of open crack on vibration behaviour of a fluid-conveying pipe embedded in a visco-elastic medium, *Latin American Journal of Solids and Structures*, Vol.13, pp.136-154, 2016.
- [9] In-Soo, S., et al., Dynamic behaviour of forced vibration of elastically restrained pipe conveying fluid with crack and concentrated mass, 9-th international Conference on Fracture & Strenght of Solids, Jeju, Korea, 2013



## INTERNATIONAL ACTIVITIES OF MECHANICAL ENGINEERING STUDENTS AT THE TECHNICAL FACULTY "MIHAJLO PUPIN" ZRENJANIN

**Eleonora Desnica<sup>1</sup>, Višnja Mihajlović<sup>1</sup>, Simona Dzitac<sup>2</sup>, Jasmina Pekez<sup>1</sup>**

<sup>1</sup>University of Novi Sad, Technical Faculty "Mihajlo Pupin", Zrenjanin, Serbia

<sup>2</sup>University of Oradea, Energy Engineering and Industrial Management Faculty, Oradea, Romania

e-mail: [desnica@tfzr.uns.ac.rs](mailto:desnica@tfzr.uns.ac.rs)

**Abstract:** Internationalization as one of the priorities is increasingly recognized by numerous countries and higher education institutions. In this area, a special place is occupied by the mobility of students, which at our universities, for now, to the greatest extent, is carried out through the programs Erasmus+, CEEPUS III and others. The aim of this paper is to show the contribution of student mobility and participation in international student conferences within the Mechanical Engineering study program at the Technical Faculty "Mihajlo Pupin", Zrenjanin, in achieving academic mobility as one of the most important goals of the internationalization strategy of universities in Serbia within the Bologna process.

**Key words:** internationalization, CEEPUS, ERASMUS+, student mobility, student conference

### INTRODUCTION

The internationalization of higher education is defined as the process of including international elements in teaching and research and is a trend that has been rapidly developing in Serbia in recent years [1]. When the internationalization of higher education is mentioned, the first association is certainly mobility, and within it, the mobility of students comes first [2].

At Universities, internationalization is, for now, to the greatest extent, carried out through student mobility - Erasmus+, CEEPUS III, and others [3]. Technical Faculty "Mihajlo Pupin" participates in these programs and motivates students to take part in academic mobilities with the aim of expanding and deepening international cooperation and internationalization of our Faculty.

The importance of student mobility and their international activities through conferences goes beyond the need to realize the international dimension of higher education. The mobility of students facilitates their employability, supports interculturality, achieves the goals of the Bologna process and the European area of higher education, and affects the increase in the competitiveness of the economy on the global market [4,5].

The paper shows the active participation of students of the Mechanical Engineering study program at the Technical Faculty "Mihajlo Pupin" Zrenjanin in the process of internationalization and participation in various programs of international cooperation through mobility and participation in an international conference in the academic year 2022/2023.

### ERASMUS+ PROFESSIONAL STUDENT PRACTICE

As part of the Erasmus+KA103 [6] professional student internship program, student of the 3rd year of Mechanical Engineering, Đorđe Bačić, fought in the period from 06.02.2023. until 05.04.2023. at the company Voestalpine components Fontaine in the city of Belfort, municipality of Fontaine, France. Fontaine is a settlement and commune in northeastern France in the federal state of Bourgogne-Franche-Comte in the department of Territoire de Belfort.



Đorđe applied to the unique public call of the University of Novi Sad for the application of UNS students for Erasmus+ outgoing mobility and for the purpose of realizing a student internship during the academic year 2022/2023.

The opportunity for an internship within the company is available to students from all scientific fields, provided they are able to identify a suitable partner with whom they can undertake a two- to three-month internship. This internship can then be recognized at their home faculty through the subject of Project work.

In the company, the student held the position of mechanical engineering practitioner for the design and maintenance of machines and press tools. As part of his work in the maintenance sector, Đorđe had the opportunity to repair several press tools together with his colleagues from that sector and learn what are the most common failures of those tools and what problems workers face when servicing the tools.

During his two-month internship, he actively engaged in five studies/company projects that involved examining the design and quality of two different components for Peugeot, as well as conducting assessments of the design and quality of two distinct testing tables. In addition to his project work, he also participated in internal online training sessions focused on human rights within the company, workplace safety, and information security protocols. The combination of practical experience and knowledge gained from these training sessions has further enriched his professional development during the internship.



*Fig. 1. Photo with colleagues from the maintenance and production sector*

In addition to the time spent at the company, Đorđe used his free time to visit some sights of the surrounding cities, as well as the Peugeot museum, where you can see the entire history of the car manufacturer from its foundation to the present day. The most interesting was certainly the Peugeot 406 vehicle that was used in the movie Taxi and the original copy of the car from the movie is preserved in that museum.



*Fig. 2. The photo next to the vehicle from the movie Taxi*



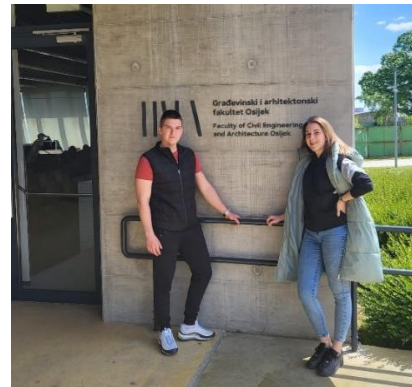
## STUDENT EXCHANGE THROUGH THE CEEPUS NETWORK

The Central European Exchange Program for University Studies has the acronym CEEPUS [7]. The main goals of the program are the establishment of multilateral cooperation through academic mobility within the Central and South European regions, the promotion of study programs and academic networks, especially joint diplomas, the promotion of understanding and specificity of the region, and assistance in establishing the European higher education area.

The program enables the mobility of students and university professors, as well as language courses and excursions. An important feature of the program is university networks, which are based on cooperation between at least three universities, provided that all three universities from different countries are members of the CEEPUS program.

Mechanical engineering students Miloš Marković, Miloš Đurin (IV year of study), Veljko Veličković (III year of study), and Olivera Čikoš (master's studies) participated from 17.04.2023. until 17.05.2023. in international exchange within the CEPUS network at the Faculty of Electrical Engineering, Computing, and Informatics (FERIT) and at the Faculty of Civil Engineering and Architecture, Josip Juraj Strossmayer University in Osijek.

During their visit, the students had the opportunity to explore various laboratories at the faculty, including those dedicated to conducting energy efficiency tests on materials and testing materials used for temperature-controlled wall construction. They also attended lectures and had attended the Festival of Science. Additionally, they made time to discover the city of Osijek, and make new friendships along the way.





*Fig. 3. Students and the laboratories of the faculties in Osijek*

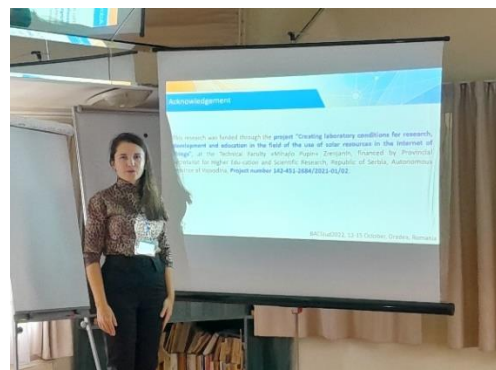
## INTERNATIONAL CONFERENCE AT AGORA UNIVERSITY OF ORADEA, ROMANIA

The International Symposium "Brainstorming in Agora Students' Scientific Circle", Agora University of Oradea, Romania [8] is part of the logic and practice of student-centered education as a continuation of student involvement in projects, mobility, and entrepreneurial activities. This symposium aims to create a friendly meeting environment, a bridge between students and mentoring teachers with similar concerns from all over the country, but also with international expansion for future collaborations. The event coordinator is prof. dr. eng. ec. Simona Dzitac, president of the Association Cluster of Scientific Research, Innovation and European Studies from Oradea.

The professors of our faculty (prof. Eleonora Desnica, prof. Ljiljana Radovanović, prof. Ivan Palinkaš) have been participating in the organization of this conference as members of the scientific committee from the beginning.

The International Symposium "Brainstorming in the Agora of Student Circles", BACStud, aims at the following objectives: Creating a friendly work environment suited to generate a bold "storm of ideas", without the fear of mistakes, which slows down creativity; Discovering potential talents among participants with inclinations towards research and innovation; Deepen the skills and abilities to write scientific papers and to present their ideas publicly in an attractive form; Encouraging participants in research, innovation, development, and application of results.

Every year, students and assistants of our faculty and the Mechanical Engineering study program participate with papers at the conference. At the conference in 2022., the paper of our assistants Milica Mazalica and Siniša Mihajlović, „Approach in mapping solar radiation data in the geographic information system“, won the first prize for the quality of research and the communication of the scientific work in international section in English.





**Fig. 4.** The 8<sup>th</sup> International Symposium Brainstorming in Agora Students Scientific Circle – BACStud2022

## CONCLUSION

Students who took part in the mobilities say that this type of exchange enabled them, first of all, to acquire valuable practical knowledge and experience, but also to learn about new cultures. Through the implementation of student mobility at reputable academic institutions, a wide field of opportunities for improving knowledge and skills has been opened. The students highlight the tremendous value they have gained from their involvement in international activities, emphasizing it as an opportunity that should not be missed by anyone. They express their gratitude for the enriching experiences and affirm that the knowledge and growth they have acquired are truly invaluable.

The Department of Mechanical Engineering plans to continue to support exchange programs and student participation in international conferences, as well as to work on further expanding the network of partner institutions in order to ensure the possibility of as many mobility opportunities as possible. In this way, internationalization is a process that is not a goal in itself but a way to improve the quality of higher education as a whole.

## REFERENCES

- [1] Matijašević - Obradović, J., Carić, M., Zarubica, S., Značaj internacionalizacije univerziteta i njen uticaj na kvalitet obrazovanja, XXVI Skup TRENDOVI RAZVOJA: INOVACIJE U MODERNOM OBRAZOVANJU, pp. 571-574, Kopaonik, 16 - 19. 02. 2020.
- [2] Škorić, S., Kulić, M., Matijašević – Obradović, J., Internacionalizacija visokog obrazovanja kroz mobilnost nastavnog osoblja, XXVI Skup TRENDOVI RAZVOJA: INOVACIJE U MODERNOM OBRAZOVANJU, pp. 542-545, Kopaonik, 16 - 19. 02. 2020.
- [3] Sokolović, D., Bikić, S., Kljajić, M., Anđelković, A., CEEPUS mobilnosti studenata na Departmanu za energetiku i procesnu tehniku, Fakulteta tehničkih nauka, UNS, XXIV Skup TRENDOVI RAZVOJA: DIGITALIZACIJA VISOKOG OBRAZOVANJA, Paper No. T4.1-7, Kopaonik, 21. - 23. 02. 2018.
- [4] Krklješ, M., Reba, D., Đuričić, O., Milinković, A., Internacionalizacija u oblasti arhitekture kroz programe mobilnosti studenata i nastavnog osoblja, XXIV Skup TRENDOVI RAZVOJA: DIGITALIZACIJA VISOKOG OBRAZOVANJA, Paper No. T4.1-6, Kopaonik, 21. - 23. 02. 2018.
- [5] Desnica, E., Vulić, M., Obrazovanje 21. veka u funkciji unapređenja veština i kompetencija inženjera, Naučni skup INOVAEDUCATION 2018, pp. 129-139, Novi Sad, 2018.
- [6] <https://tempus.ac.rs/erasmus/>
- [7] <https://www.ceepus.info/>
- [8] <https://www.univagora.ro/en/conferinte/bacstud/>





## THE ROLE OF CERIUM AS RARE EARTH ELEMENT AT ONE HOT WORK TOOL STEEL

Zoran Karastojković<sup>1</sup>, Nikola Bajić<sup>1</sup>, Jasmina Pekez<sup>2</sup>, Zoran Janjušević<sup>3</sup>

<sup>1</sup>IHS IRC Technoexperts, Batajnički put 23, 11080 Zemun, Serbia

<sup>2</sup>University Novi Sad, Technical faculty „Mihailo Pupin“, 23000 Zrenjanin, Serbia

<sup>3</sup>Institute for nuclear and other mineral raw materials, Franchetd'Esperais, 73, 11000  
Belgrade, Serbia

e-mail: [zoran.karastojkovic@gmail.com](mailto:zoran.karastojkovic@gmail.com)

**Abstract:** Only a few of rare earth elements (REEs) could be found at tool steels for hot deforming, but their properties and (dis)advantages still are not well known to many consumers.

Tool steels always have had a crucial role in various mechanical engineering production methods, either in casting, cutting or deforming processes. In spite of that, the new production methods and further the properties of such obtained tool steels are not well known to many tool designers & technologists. A lot of tool steel grades are renewed, approximately about 60% of total steel number is changed or improved just in last two decades. Modern mechanical engineering could not be imagined without qualitative tool steels.

The new production methods usually bring up a more advanced steel properties. The enlarged hardenability and wear resistance are typical demands from the every tool steel, no matter what for is particular tool steel used, commonly in cutting or deforming processes. It is always expected that such steel possesses the pretty low level of non-metallic inclusions, and those levels could be obtainable only by using a specific refining processes during steel making. The most known new processes of tool steel making here are explained on the comprehensive level to the tool designers and other mechanical engineers, involved in the choosing the most desirable tool steel. Here will be shown why cerium is one of desirable elements in a kind of tool steel for hot extrusion.

**Key words:** tool steel, production & refining methods, cerium, tool cleanliness

### INTRODUCTION

The contemporary mechanical engineering could not be imagined without qualitative tools and materials. It is considered that about 60% of total tool steel number is changed in last two decades. Such miracle changes were provided by many efforts in processing of tool steels. The advanced method of producing the qualitative tool steels offer better properties in comparison to older types of steels. Some methods of steel melting or refining are the warranty for improved to many tool designers or consumers.

The enlarged hardenability and wear resistance are typical demands from every tool steel, no matter what kind of steel is used (for casting, cutting or deforming). The large number of production methods were involved in technology of refining during steel melting. The refining of the melt is the essential step in the production schedule [1,2]. The way of refining (under the protective atmosphere, method of degazing, vacuum treating, melting under the slag, double or triple remelting, etc.) often is emphasized even in the offer for sale. From that point of view, here is shown one contemporary method used in tool steel production, which is interesting for mechanical engineers and other as users of tools.

Many steels for hot working tools contain main alloying elements, such as Cr, W, Mo and V, but not cerium [3-5]. Here will be analysed the presence of cerium at one steel for a hot working tool, used for extrusion of copper, as one heavy thermal and mechanical loaded tool.

## PRINCIPAL USAGE OF REEs

Rare Earth Elements (REEs) are used in many devices, in past decades an explosion in demands for these elements and their alloys has happened. Only twenty years ago there were small number of cell phones in use, however, but today the estimation about the number of these phones is over 7 billion. Alloys used for rechargeable batteries in phones or portable computers, in memory devices, and as catalyst in electric vehicle or hybrid-electric vehicle are produced from REEs, as shown in Fig. 1.

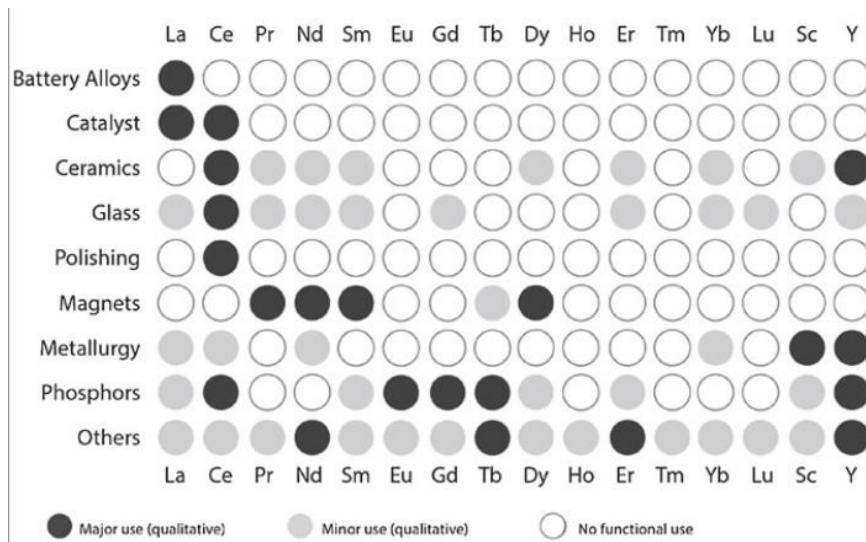


Fig. 1. Distribution of REEs for various usage

The use of REEs metals in metallurgy processes for production of various alloys varies from 7 to 20%, depending from the time and/or country. Materials as glass, marble, granite and other gemstones are often polished with cerium oxide powder.

The REEs are not really rare in content: in the Earths crust many other valuable elements are much more abundant, for example cerium is 15000 times more abundant than gold.

## CERIUM IN STEEL

Cerium is silvery-white metal, on air fast becomes dark, pretty soft - only  $\approx 30\text{HB}$ , lighter than iron- density is  $\rho=6,79\text{g/cm}^3$ , and melts at pretty low temperature - at  $795^\circ\text{C}$ . REEs attracted great interest in order to understand the their role in both structural or tool steels, no matter that the solubility of almost REEs in solidified iron is pretty low, while in Fe melt they are completely dissolved. Cerium with iron makes an eutection reactin which melts at temperature less than  $600^\circ\text{C}$ , see diagram at Fig. 2. In spite of such low solubility cerium attracted interest in production of qualitative steels, no matter that in system Fe-Ce there is no any strong phase.

It is worthy to emphasize that cerium with all interstitial elements or inclusions present in steel is able to make compounds as like: hydrides, oxides, nitrides, sulfides, phosphides or silicides. During chemical reaction of cerium with many elements present in molten steel, the large amount of heat is liberated, it means that those reactions are exothermic.

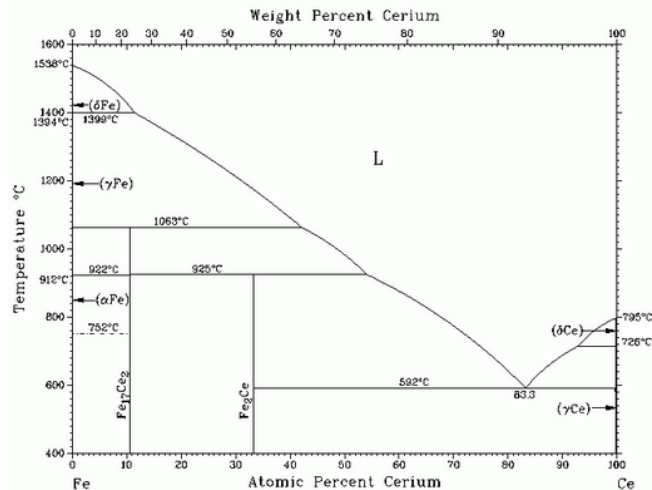


Fig. 2. Phase diagram Fe – Ce

According to strong affinity to other elements, especially to non-metal inclusions, cerium may serve for treating a liquid metal, it means for a kind of refining. Cerium is added into molten steel in the form of ferrocerium.

### INFLUENCE OF REEs ON GRAIN REFINEMENT IN STEEL

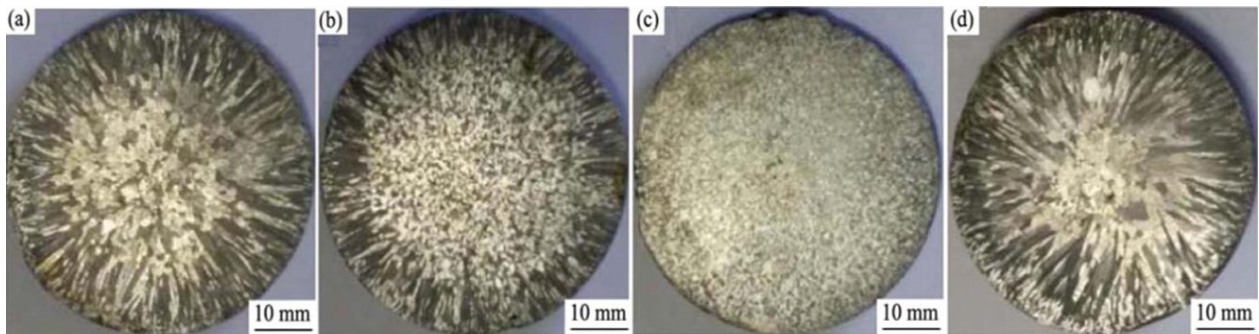
It is widely known that microalloying elements (MLE) play an important role in structural steels while in tool steels they have a kind of hidden role in comparison to main alloying elements. The conventional refining of steels, used either for structures or tools, consists of adding the strong carbide elements, frequently Nb, V and Ti [2-6]. The role of REEs in tool steels, either is positive, is hardly known, and from that point is needed to explain their advantages.

Cerium finds application in producing of nodular iron, for inoculation the structure. After such treating of molten metal with cerium in amounts about 0,2%, the mechanical properties of solidified metal are increased. Thanks to its high surface activity in melts, cerium is started to apply in producing of qualitative tool steels.

In the period of steel making, the molten steel generally may be treated either by inoculation for refining the structure just during melting or later after solidification - through the deforming process, when austenite grains are refined (usually by hot rolling). Many production methods were involved in technology for refining the steel microstructure. The refining of the melt is first step in the production schedule of steel. There are developed various ways for refining the melt: under the protective atmosphere, inoculation, way of degazing, vacuum treating, melting under the slag, double or triple remelting, etc. The refining of the melt is one of the most effective method for improving many properties, including the formability of the sheet form. Addition of REEs was applied into structural steels but some producers in past decades introduced one or more from those elements into tool steel. Hot work tool steels are exposed both to high stresses and temperatures during forging/extrusion. Cerium is one element from group of REEs which has shown some useful advantages in such kind of tool steel.

Grain refining of solidified steel, when cerium is added, also is recorded in an industrial practice, firstly in structural steels and later in tool steels. Degassing of steel melt with REEs also is happened, as desired reactions in modification of steel properties.

The effect of modification of solidified structure sometimes is visible nearly by naked eye, in Fig. 3. are shown some examples.



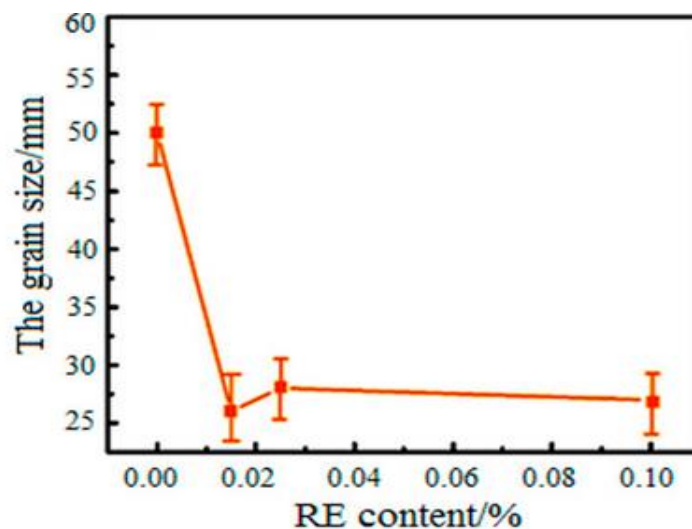
**Fig. 3.** Microstructures of as cast ingot  $\varnothing 10\text{mm}$  from ferritic stainless steel 434 (ASTM):  
a) without Ce; b) with 0,011%; c) with 0,023% and d) with 0,034%Ce [7]

It is evident that a large amount of Ce, Fig. 3d), does not make desired refinement of grain size in steel, just contrary. During solidification, REEs segregate at grain boundaries. Many other REEs also may react with the nitrogen, dissolved in molten steel. That's why RE elements are worthy for studying.

In the theory of casting but also in practice, is well established that refinement of as-cast structure is an effective method for improving mechanical properties, formability, even the surface appearance of castings. During solidification process of steel, cerium will be rejected from a solid phase and segregate at grain boundaries,

#### CERIUM AND GRAIN SIZE IN CAST H13 TOOL STEEL

In small amounts of cerium [5] up to 0,02% in H13 tool steel, as one representer of steel for working at elevated temperature, has shown the decreasing effect on grain size, but larger amounts of cerium has no further effect on grain size, Fig. 4.



**Fig. 4.** Grain size changes in as-cast H13 steel [8]

Cerium shows the great affinity toward oxygen and sulfur, and melting temperature of formed cerium oxides and sulfides are pretty high, over 1900°C. This fact is importance for understanding the role of cerium oxides or sulfides during crystallization of steel: in structural steels the solidification begins in delta ferrite, phase with the highest melting temperatures. This is way on which cerium acts as a grain refiner on delta phase but not on gamma phase. Such treated tool steel is able to submit the higher loads and working temperatures [4-6], which are far away from atmospheric conditions.

## Cerium compounds of interest for nonmetallic inclusions

Either the pure cerium possesses a pretty low melting temperature, some of the oxides and sulfides of cerium are melting at  $\approx 2500^{\circ}\text{C}$ . So, cerium is added into molten steel to react with both oxygen and sulfur, making nonmetallic compounds which are less harmful. Further, cerium makes a number of oxides and sulfides. It is established, by XRD or similar analytical techniques, that cerium inclusions (almost as  $\text{Ce}_2\text{O}_3$  or  $\text{Ce}_2\text{O}_2\text{S}$ ) will be formed when solidification of treated steel is finished. After treating a molten steel, the ductility (toughness) could be enhanced. This is an important property/ability, either for structural or tool steels.

The shape and size of non-metallic inclusions are changed after cerium addition into molten steel, it means that cerium acts as grain refiner. Formed inclusions on cerium base are more desirable than for example of manganese sulfide ( $\text{MnS}$ ). In many structural steels the  $\text{MnS}$  is an obvious nonmetallic inclusion [8]. It implies on improving the ductility of such treated steel. Cerium-sulfur phase diagram still is not well investigated. Cerium with sulfur makes four compounds:  $\text{CeS}$ ,  $\text{Ce}_3\text{S}_4$ ,  $\text{Ce}_2\text{S}_3$  and  $\text{CeS}_2$ , from left to right in Fig. 5.

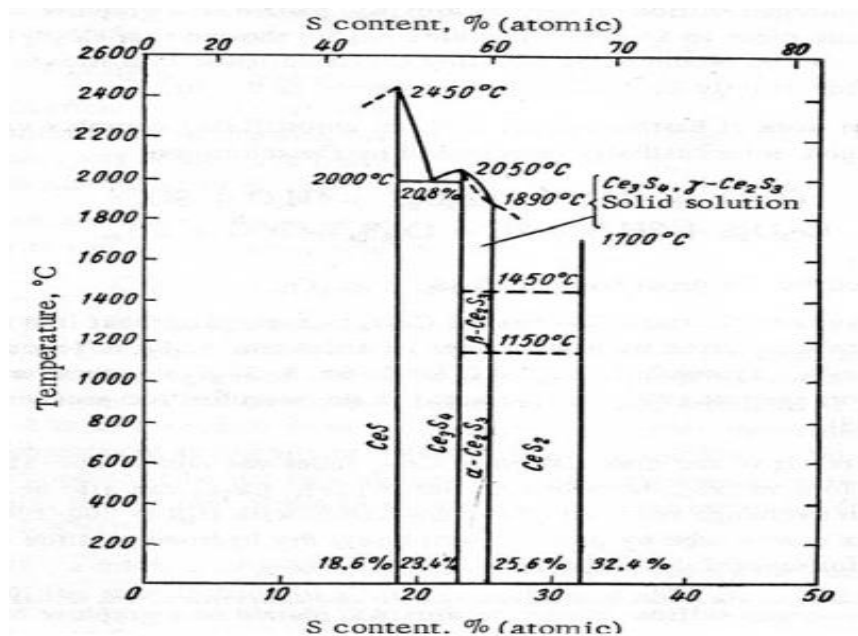


Fig. 5. Cerium-sulfur phase diagram (Samsonov 1964)

From various sulfides, the  $\text{CeS}$  possesses the highest melting temperature, see the same diagram. The formed cerium sulfides may further react and form another kind of compound, for example cerium oxysulfides.

Silica is often present as nonmetallic inclusion in steels, and cerium oxide may react with it giving the cerium-silicate  $\text{Ce}_2\text{O}_3 \cdot 2\text{SiO}_2$ . Further, it could be expected that cerium will form inclusions as  $\text{Ce}_2\text{O}_2\text{S}$ , when one atom of oxygen is replaced in compound  $\text{Ce}_2\text{O}_3$ . These facts show that the investigation of cerium behavior in molten or solidified steel is pretty complex, and many other disciplines (as X-ray techniques, crystallography, metalography, mechanical and technological testing, etc.) should be applied.

For classification of nonmetallic inclusions were developed and standardized scales for more precise definition of inclusion type, way of distribution, size, etc. [9,10].

## CONCLUSION

The servicing life of every tool, in spite of working conditions, markedly is determined by a kind of used steel.

Pure cerium practically is insoluble in iron. Even though cerium possesses a pretty low melting temperature ( $\approx 800^{\circ}\text{C}$ ), but its oxides and sulfides are melted at pretty higher temperatures, in



interval 1900-2500°C. The main role of addition of cerium into the molten steel is first of all to react with oxygen and/or with sulphur.

Thanks to its high surface activity in melts, cerium is started to apply in producing of qualitative tool steels, firstly on the behalf of structure modification/refining. Forming of non-metallic inclusions by adding of cerium in amount  $\approx 0,2\%$  into steel for hot extrusion of copper products, such steel has shown the beneficial effect on tool service life.

This is of importance for exploiting the tool steel for hot deforming, but also could be said for other demands or qualitative structural steels.

## REFERENCES

- [1] B. Kočovski: Teorija livarstva, in Serbian, Bor 1994, Univerzitet u Beogradu-Tehnički fakultet u Boru, p. 85-124.
- [2] Н.Ф. Легированнаја сталь, in Russian, Москва 1963, Металлургиздат, p. 86-116.
- [3] М.И. Виноград, Г.И. Громова: Вкљученија в легированн'их сталјах и сплавов, in Russian, Москва 1972, Металлургија, p. 23-148.
- [4] А.В. Бобилев: Механические и технологические свойства металлов, in Russian, Москва 1980, Металлургија, стр. 224-235.
- [5] Yu. Geller: Tool Steels, Moscow 1976, Mir Publishers, p. 512-554.
- [6] Ју.Ф. Шевакин, Л.М. Грабарик, А.А. Нагајцев: Прессование тјажелних цветних металлов и сплавов, in Russian, Москва 1987, Металлургија, стр. 211-218.
- [7] S. Zhang, Y. Yu, S. Wang, H. Li: Effects of cerium addition on solidification structure and mechanical properties of 434 ferritic stainless steel, J. of Rare Earths, 35/2017/5, p. 518-524.
- [8] J. Gao, Paixian Fu, H. Liu, D. Li: Effects of Rare Earth on the Microstructure and Impact Toughness on H13 Steel, Metals, 2015/5, pp. 383-394.
- [9] Z. Karastojković: Praktikum za laboratorijske vežbe iz predmeta Materijali, in Serbian, Beograd 2015, Visoka tehnička škola strukovnih studija Novi Beograd, p. 189-204.
- [10] В.А. Кудрин: Металлургија стаљи, in Russian, Москва 1989, Металлургија, p. 134-155.
- [11] Z. Karastojković, R. Perić: Nerđajući čelici, in Serbian, Inženjersko društvo za koroziju, Beogradm „Perić&Perić“, Požarevac, Beograd 2021, p. 65-74.



## SYNERGIC AND DEVELOPMENTAL MULTIDISCIPLINARY IN MAINTENANCE OF COMPLEX TECHNICAL SYSTEMS IN ONLINE ENVIRONMENT

Zlatko Lacković <sup>1</sup>, Milan Ivanović <sup>1</sup>, Krešimir Lacković <sup>2</sup>

<sup>1</sup> Panon - Institute for Strategic Studies, Osijek

<sup>2</sup> University of Koprivnica

e-mail: [panon.institut@gmail.com](mailto:panon.institut@gmail.com)

**Abstract:** The paper deals with multidisciplinary in the maintenance and management of complex technical systems. This primarily refers to maintenance or technical diagnostics, which is increasingly becoming part of the management technological process. In addition, business activities, especially commercial activities, are integrated into this joint process, and with the development of IT technologies, everything becomes integrated into a joint management process. It is hypothesized that complex technical systems in the business and market sense are not spatially limited by state borders, so there is a need for cooperation in the production and development goal. This enables them to develop IT technologies, especially the Internet. With the goal of mutual cooperation between several business organizations that have technical systems, a model of joint relations with the public is proposed as a common strategic need and business interest. The subject of continued research can be artificial intelligence, which can serve as software that provides new solutions for optimizing business processes, especially based on changes in production inputs.

**Key words:** technical system, diagnostics, process, management, PR

### INTRODUCTION

The development tendencies of the world economy are the creation of a large number of small companies and a smaller number of large, particularly technical systems. A fundamental feature of larger technical systems is the increasing involvement of technique and technology, which requires sophisticated forms of management and maintenance. The development of technique and technology, especially informatics, enabled a high degree of automation of complex technical systems. In addition, such economic entities are not limited by their business and market locally, but also by the state. This particularly applies to technical systems that complement each other in their production programs. In such complex technical systems, there is a special emphasis on their flawless maintenance, which is technical diagnostics. This means that continuous controls enable the smooth flow of the technological production process, so technical diagnostics is increasingly becoming part of the management process of production and operation of the technical system.

If information flows are converted into functional relationships, then, with appropriate hardware and software solutions, the complete production and business process can be managed with the goal of optimization. For example, by adjusting and controlling mathematical relations or functions, set such forms of production functions that the capacities enable minimum costs per product unit, or the lowest cost prices. Subsequently, this process can be connected to similar processes in other technical systems, so experiences from the field of production, system maintenance and development can be exchanged.

Based on the development of hardware and software solutions, a hypothesis is put forward about the multidisciplinary joint activity of several technical systems. In this sense, the goal is not only production and development technical cooperation, but also marketing, especially cooperation in the field of public relations. With the development of technique and technology as well as economic relations, relations with the public are becoming an increasingly important

strategic managerial activity. This especially applies to complementary technical systems whose operations and market are not limited by state and other obstacles.

In terms of content, the management and maintenance of the production and technical system is first proposed. The next procedure is the modeling of the mathematical process in accordance with the technical flows. This is a prerequisite for the application of appropriate hardware and software in order to adapt everything to computer control. A virtual connection between several technical systems can be achieved with special software used to communicate with each other or via video conference for joint communication.

Due to the fact that the activity of public relations (or PR) has become not only a marketing but also an important strategic managerial one, a model in which several technical systems participate is proposed. This achieves the technical-economic multidisciplinary of the complete system, which is the main goal of this work. As a continuation of the research, there can be artificial intelligence, which can be used to provide software solutions based on information about imputation changes in order to set the capacities of individual phases with the goal of minimum cost prices, but also other business and market assessments and decisions.

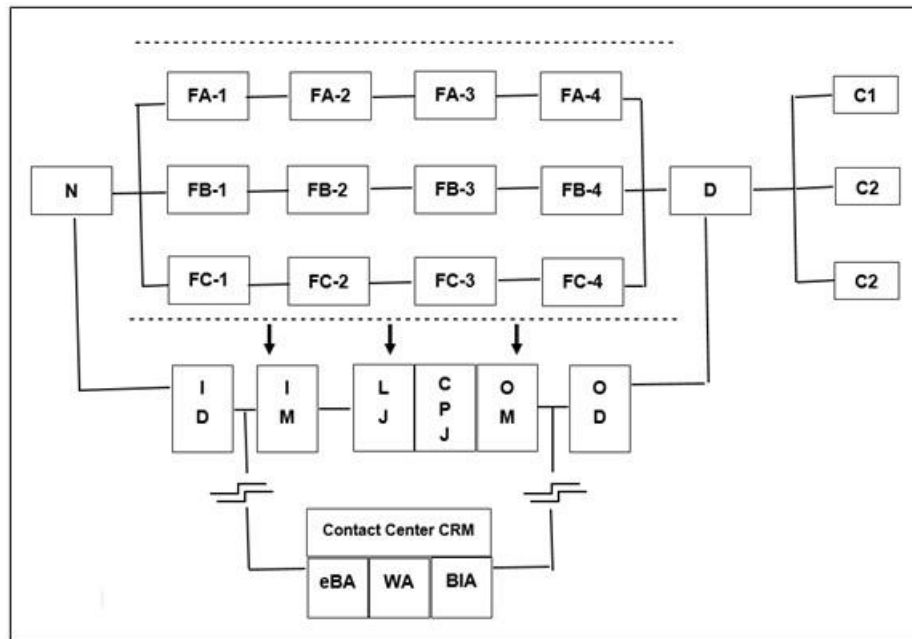
## **CHARACTERISTICS OF COMPLEX TECHNICAL SYSTEMS AND THEIR MAINTENANCE**

In terms of this consideration, the basic question arises as to what is specifically meant in this case by the phrase technical systems. The definition of technical systems starts from several facts. A technical system is a series of interconnected components that transform, transmit or control materials, energy and information with a specific purpose. In any system, the way its components work together is as important as their performance and individual characteristics [9] Therefore, technical systems are the result of human creativity. They are also called goal systems because of their purpose set by man as a creator. These systems do not appear by themselves, but regularly within the framework of organizational or production systems. According to the definition, technical systems represent a set of constituent parts, their relations and special features, which are structured in such a way as to ensure the foreseen work procedures and execution appropriate functions in a certain time and conditions. Every technical system has the following types of components, which are often used as categories for process analysis. [1]

- Material components. In this category comes the raw material necessary to start the process, the energy used for its transformation and the technical equipment (technology) that enable action on it.
- Agent components. People involved in the process, who give it load Culture, values, skills, knowledge, and play a vital role in their interaction with the system, as operators, supervisors, regulators, controllers, etc.
- System structure. This refers to the specific way in which other system components are arranged and interconnected. Based on this, it is possible to identify two types of processes: management and transformation. The former control the process, and the latter are the ones who actually perform the work.
- Process results. Results are objects and actions obtained at the end of the process, regardless of whether they are desired (successful process) or not. It is possible for two technical systems that have similar components and structures to give different results. In terms of hardware Fig 1. shows an example of a complex technical system that has three phases of operation and each phase has four operations.

Figure 1 shows an example of the functioning model of a complex technical system that consists of three production phases, and each phase has three work operations. Technical solutions can be used to control certain energy and information flows in each operation, which can be adjusted for management using measuring transmitters, converters, amplifiers, translators and other hardware and software options. In the technical sense, this is solved by a PLC (Programmable logic controller), i.e. a digital electronic device that uses program memory to remember commands that order the execution of specific functions, such as logic functions, counting, time measurement, and calculation in order to manage different types of processes and devices through digital and analog input-output modules.[2] the development

of technique and technology, especially informatics, today enables far more complex hardware and software informatics that enable monitoring and management of all elements of the process as well as its maintenance and technical diagnostics.



**Fig.1. Functioning of a complex technical system**

Legend: N-procurement, FA 1-4 first phase with 4 operations, FB1-4 second phase, FC1-4 third phase, D-distribution, CK1-C3 customers, ID - input device, IM - input module, CRM - software for customer and environment management, eBA - e-business applications, WA - work applications, BIA - business intelligence applications, OM - output module. OD - output device

Figure 1 shows the functioning of a complex technical system of three phases and twelve operations. In all important places there are detectors connected to the computer via converters, transmitters, amplifiers and other necessary hardware devices. The obtained data is processed and displayed in the control center. The complexity of the hardware and software enables the monitoring of the necessary technical control variables as well as those that are managed with technical diagnostics. Connection using CRM enables remote management as well as communication with other companies for maintenance-diagnostics and complementary complex technical systems. CRM is a set of software methods for managing relationships with clients (Customer Relationship Management). [3] In essence, it is about conducting electronic business, by understanding the behavior and needs of business partners, using appropriate communications. The system has a contact center with which it maintains connections with customers or clients as well as other systems. The connection is supported with the help of the Internet or galvanic access, and one-sided connections via websites, social networks or video conference are also possible. Within the contact center. business e-applications, work e-applications, database and business intelligence applications are stored with the maintainer. This system is harmonized and upgraded to a complex technical system, and communication between technical systems and their environment is achieved using appropriate IT solutions.

## PRODUCTION-MANAGEMENT FUNCTION OF A COMPLEX TECHNICAL SYSTEM

After the technical system is adjusted in terms of hardware and software. management of technical or IT processes is made possible by analog conversion of energy and information signals into a functional relationship. All technical quantities are converted into mathematical causally dependent ones, so the following functions can be created:

- Relationship of product quantity in time,
- Ratio of costs per product unit (cost price) and capacity utilization.

- Monitoring of technical parameters in accordance with processes in individual stages and operations of production.

When all flows are translated into mathematical relationships, then the complete production, technical and IT process can be managed in order to optimize it.

The given example of a complex process shows production functions, i.e. the dependence of individual product costs (cost price) in a certain time. This is technically possible with a sufficient number of detectors that at all times show such parameters that the appropriate software converts into costs. In the figure, it is assumed that this system has a large number of processes and thus production functions. By combining them, a joint production function is obtained, where the individual costs are finally obtained at certain times in order to determine the optimal capacity (lowest cost price), but the other costs related to maintenance also move along. This refers to energy consumption, rate of wear and tear of rotating devices, overheating, etc. These costs are something new that needs to be monitored and diagnosed. Of course, this complete system can also use more modern IT technologies in which the signals that follow the flow of production functions can be processed. This can be linked and reconciled with measurement and other maintenance-related data. Accordingly, a software-hardware solution in a technical sense can enable the management of the production function (cost price) and the diagnosis of data related to maintenance. The continuation of the development approach is an online connection that enables maintenance management where no distance and other limitations (state borders) are an obstacle to successful cooperation. The aforementioned synergistic approach can be particularly effective when exchanging information with business partners regardless of their location. This can be various development, technical and marketing information. On this occasion, the starting point of consideration is the joint PR of several companies that deal with the maintenance of complex technical systems. The reason for this cooperation stems from the fact that these are companies that must follow the latest technical and technological achievements in order to effectively perform the maintenance function, which in such cases is actually technical diagnostics as a very sophisticated form of maintenance. In addition, when it comes to complementary technical systems, the appropriate hardware and software solutions enable joint access to relations with business partners and clients. In this sense, it is first necessary to organize a model of technical diagnostics and system management, and then harmonize with this a model of mutual cooperation and relations with common customers and the rest of the business public.

## **TECHNICAL DIAGNOSTICS OF COMPLEX TECHNICAL SYSTEMS**

The term diagnosis is known and related to the field of medicine where the disease or the cause of the disease is determined. Something similar applies to technical systems, and in any case it is about some kind of recognition, evaluation and conclusion. In this case, it is specifically about determining the state of a technical system. From a broader perspective, it is about monitoring the change in state by measuring the appropriate parameters according to the type and complexity of a technical system. [4] Technical systems where technical diagnostics are performed can be construction objects, machines and equipment as well as installations, as well as agricultural equipment and IT hardware or software.

The peculiarities of technical diagnostics are best derived from the following definitions:

- Technical diagnostics, as an integral part of the condition-based maintenance model, should determine the technical condition of a component and/or system with a certain accuracy at a certain moment in time. [5]
- In its essence, technical diagnostics represents a technical discipline that deals with monitoring the state of correctness of machines, equipment, devices and plants. [6]
- Technical diagnostics, as an integral part of the maintenance process according to condition, should determine the technical condition of a component part of the system with a certain accuracy at a certain point in time - a science that deals with recognizing the technical condition of the system. [7]

In this case, we have an example of a complex technical system, where technical diagnostics includes the following activities:

- Testing of machines, equipment and installations, i.e. the complete production process.
- Testing the functioning of the complete information hardware.
- In particular, examination of IT diagnostic software, and especially production and software related to external communications.

This schedule of activities allows determining the functioning and management of multiple information processes. First of all, we can mention the fact that comes from the progress of the development of technique and technology. It is actually about the fact that the maintenance of complex technical systems, especially technical diagnostics, grows into a management process that has wider implications, as support for the management process but also for other commercial or marketing activities. The first is the process of technical diagnostic information. In parallel with this, the management process of the production function takes place, and certain cost-quantity optima are achieved. On top of that is the CRM process, which establishes communication with complementary technical systems and their common environment, i.e. the public. In this way, a synergistic effect is achieved because technical-production and marketing information are exchanged, all with the goal of common interests. In modern business, special attention is given to public relations as a very important strategic activity, especially for complex technical systems.

#### **A MODEL OF COOPERATION OF MULTIPLE TECHNICAL SYSTEMS WITH SPECIFIC OBJECTIVE OF IMPROVING PR WITH THE SUPPORT OF INTERNET TOOLS**

Complex technical systems at regional levels do not have to be in competition with each other. They have in common that they are complex and that they can organize technical diagnostics in a similar way, but they also have similar problems and needs. In addition, complex technical systems can be complementary to each other and create conditions for cooperation, especially in the domain of development and marketing. On this occasion, the starting point will be public relations, because this is an activity in full development, especially with complex systems. In this sense, it should be noted that most of the technical diagnostics activities can be carried out online, so there is an opportunity for synergistic action. It is the technical capabilities that are installed for the needs of on-line technical diagnostics that enable relations with the public to develop.

Given that in modern business, especially complex technical systems, PR is increasingly becoming a strategic activity, then technical diagnostics should be used for synergistic action in order to improve marketing, especially public relations. Considering the process of technical diagnostics, especially with complex technical systems, it can be seen that it is a function of the production and complete business process. In fact, the information process of maintenance or technical diagnostics is an integral part of the production and business process, but with the development of modern software it can be expanded and connected to the information processes of marketing, especially with public relations. This is extremely important in modern management because it enables mutual communication with different subjects of the technical system environment.

Public relations or PR is an activity that appeared as one of the tools of modern marketing, but it is increasingly taking on a strategic role, especially with larger or complex technical systems. The activities of the PR function derive from the definition itself, and a few examples are listed below, such as:

- Public relations represent a form of communication that, if carefully planned and implemented, ensures the long-term goals of creating a positive image that is created on the basis of long-term planned good relations with different groups of the public: consumers, employees, suppliers, stockholders, the government and other formal and informal groups in society. [8]
- Review The Public Relations Society of America (PRSA) defines public relations as "a process of strategic communication that builds mutually beneficial relationships between an organization and its public". [9]

- Public relations is a management function that establishes and maintains mutually beneficial relationships between an organization and the various publics on which its success or failure depends. [10]
- Public relations is a management function that helps establish and maintain common lines of communication, understanding, acceptance and cooperation between the organization and its public; In addition, public relations help in getting to know and react to public opinion, define and emphasize management's responsibilities to serve the public interest and the successful implementation of 8 changes, serving as a system for getting to know and predicting trends. Public relations is a function whose basic tools are research and ethical communication. [11]
- Public relations as a strategic management process builds mutually beneficial relationships between the message exchange function that focuses on influencing the management of production and business processes, that is, on behavior in the company. In addition, it affects the management function, which emphasizes communication with the public in order to include feedback in decision-making. [12]
- The previous definitions refer to the essential elements that determine public relations activities, which include the following:
  - Relations with the media - The media play an important role in the formation of public opinion, as they can inform business partners and clients and contribute to the creation of the company's image in the public.
  - Relations with the market - The market represents the public with whom you need to communicate carefully, because the company is dependent on the market, that is, those who buy your products and services. That's why it is necessary to listen to any market and find out consumer preferences through research and adapt to the results of these researches in order to constantly adapt to the needs of the market. The ultimate goal is to create a long-term partnership with consumers.
  - Relationship with the state administration and local self-government - Communication relationships with the authorities are very important for every large and complex company, such as cooperation and direct and indirect lobbying. In addition to the market, every organization also depends on its public institutions that grant work permits, pass laws, adopt procedures, and regulate market movements. In this aspect of public relations, it is necessary to follow events on the political and social scene and to adapt to the course of these events in time for the benefit of your client. More specifically, these activities relate to monitoring relevant political, legal and other key issues and to the collection of information on the activities of public institutions, all for the purpose of adapting communication to that public.
- Internal communication - Internal communication includes all communicative activities between management and employees, because a company can have an ingenious product or service, but if the person in charge of selling that product leaves a negative impact, it is very likely that there will be problems in sales. In order to avoid such a scenario, it is in the interest of employers to have satisfied employees who will transfer motorcycle companies to customers in the right way. Therefore, it is important to inform, educate and motivate employees so that they can represent the company to the public. This is achieved through various meetings, intranet and communication conversations, i.e. internal communication.
- Corporate communication-For very complex economic systems, corporate communications include all important communication processes that contribute to the defined tasks in profit-oriented economic units, and which especially contribute to the fulfillment of internal and external coordination of activities as well as the alignment of interests between the company and its stakeholders [13]
- Investor relations- Better known as financial public relations, investor relations is a type of PR that tries to increase the value of a company, strengthen the confidence of shareholders and thus reduce the cost of capital and make the company or its shares attractive to investors, financial analysts, banks and funds.



- Relationships with complementary complex technical systems-This type of relationship is needed for mutual information on common topics such as; product development, technology maintenance, common market problems and other business interests.

Based on the determination of activities, it can be concluded that public relations, especially with complex business systems, are part of strategic activities, so it is logical that information technologies should be used to connect maintenance and production process software with public relations software as part of strategic activities. In this sense, the development of information technologies is a facilitating circumstance because everything can be organized online or virtually.

Virtual communities, or online communities, are used for various social and professional groups that interact via the Internet. This does not necessarily mean that there is a strong bond between members, although Howard Rheingold, author of the book of the same name, mentions that virtual communities are created "when people continue public discussions long enough, with enough human feeling, to form networks of personal relationships"[17]. In this case, effective mutual virtual communication is possible by establishing and organizing a video conference. Video conferencing is communication through which, in real time, sound and moving images are exchanged between two or more locations, thus enabling participants to hold a business meeting or training "live".

## DISCUSSION

If the previous content is analyzed, it can be seen that the goal of this paper is the proposal of a hardware-software solution, by means of which technical and business IT flows are combined. Regardless of the fact that this is just some kind of conceptual solution, the development of technique and technology is certainly going in that direction, especially when it comes to managing complex technical systems. The starting point is technical diagnostics, which includes a large number of detectors of different physical sizes that provide a picture of the flow, state and changes in the technical system. Using linear and non-linear trend methods, detector pulses can be converted into mathematical expressions. For example, such as the dependence function of production costs per unit of product for each operation in the production function. The software solution controls and adjusts capacity values with the goal of minimum production costs per product unit, i.e. cost price. The continuation follows towards the creation of a virtual network by means of which complex technical systems and their maintenance companies can communicate. In this sense, companies for maintenance or technical diagnostics are usually not in competitive relations, but on the contrary, they have many reasons for development cooperation. The technical systems themselves, which are usually marginally dislocated, and especially if they are productively complementary, can synergistically communicate in order to develop products, organization and other improvements. To this can be added the joint activity of public relations, which, with the development of economic relations, becomes not only a part of marketing but an extremely important strategic managerial activity. The proposal presents conceptual solutions of a virtual model of joint relations with the public as evidence of the possibility of multi-disciplinary IT management. Regardless of the fact that the two-way communication has been achieved with the aforementioned proposal, the research remains to be continued with the aim of feedback management. The continuation of this topic can go in the direction of artificial intelligence research. According to one of the artificial intelligence (UI, according to the English acronym AI, from Artificial Intelligence), a part of computer science (informatics) that deals with the development of the ability of computers to perform tasks that require some form of intelligence, i.e. to be able to navigate in new opportunities, learn new concepts, draw conclusions, understand natural language, recognize scenes, etc. [14] Due to the aforementioned possibilities, artificial intelligence or software that, based on, for example, changes in imputation values, will offer such dependencies of costs on capacities, which will ensure the lowest costs per product unit, or cost price. In addition, by monitoring the market situation, it is possible to generate effective marketing activities. In any case, the integration of technical, business and marketing IT flows can increase the efficiency of complex technical systems.



## CONCLUSION

Based on the presentation of the previous content, several conclusions can be drawn. First of all, it is the justification for constantly looking for opportunities to increase the efficiency of all types, especially of production complex technical systems. In addition, it is extremely important to explore the possibilities of applying the development of IT technologies in the production, business and marketing system. In this work, the goal and hypothesis of the work was exactly the IT multidisciplinary. By showing the proposed model in its conceptual form, the need and possibility of realizing IT multidisciplinary is visible. Technical possibilities are presented as mathematical simulations of technical processes in order to optimize economic relations in production. This can enable cost optimization as an essential goal of any production process. To this, the virtual unification of public relations activities was proposed as a joint activity and the need of several complex technical systems. In the end, the need and possibility for continuing research was opened, which is the inclusion of artificial intelligence in the substantive process. There are almost no restrictions for this, and the purpose of artificial intelligence would be to make conclusions and suggestions. Based on all technical, business and marketing information, artificial intelligence can make relevant proposals or orders for certain new moments in the processes. This can be caused by a change in input data in the business process, problems in functioning and maintenance, but also new proposals within the marketing mix as well as new approaches in public relations.

## REFERENCES

- [1] <https://hr.cqlife.net/sistema-tecnico>. (access May 3, 2023)
- [2] NEMA (The National Electrical Manufacturers Association), <http://www.nema.org/about/contact>, pp 10 (access May 20, 2023).
- [3] Panian, Ž., Odnosi s klijentima, Sinergija, Zagreb, 2003, pp 115
- [4] Lacković, Z., Sustav tehničke dijagnostike, HDO-Osijek i Alberta Osijek, 2015, pp 34
- [5] Tomić, M., Adamović, Ž., Pouzdanost u funkciji održavanja tehničkih sistema, Tehnička knjiga, Beograd, 1986, pp 21
- [6] Karadžić, Bulatović, M., Mogućnosti primjene suvremene endoskopske dijagnostike u prema stanju zrakoplovnih sredstava, 1. Konferencija Održavanje, Zenica, 2010, pp 3
- [7] <http://www.rgf.ac.rs>, pp 6 (access May 21, 2023)
- [8] Kesić, T., Integrirana marketinška komunikacija, Zagreb, Opinio d.o.o., 2003., pp 43
- [9] <http://prsa.org/pressroom/aboutpr.htm>, Public Relations Society of America, (access May 17, 2023)
- [10] Cutlip S. M., Center A. H., Broom Glen M., Odnosi s javnošću, Zagreb, Mate, 2003, pp 6
- [11] Harlow, R. F. (1997.) Public relation definition through the years, Public Relations, pp 36
- [12] Tam, L., Kim, J. N. (2018). Social media analytics: how they support company public relations. Journal of Business Strategy.
- [13] Lacković, Z., Lean-građevinarstvo, Alberta Osijek, 2017, pp 125
- [14] Prister, V Media, Culture and Public Relations, 10/2019, N0 1, ISSN 1333-6371 INFO-142, pp 67-72



## OPTIMIZATION OF CUTTING PARAMETERS FOR MAXIMIZING PROFIT RATE IN MILLING USING A DETERMINISTIC APPROACH

Milan Trifunović<sup>1</sup>, Miloš Madić<sup>1</sup>

<sup>1</sup>University of Niš, Faculty of Mechanical Engineering in Niš, Niš, Serbia  
e-mail: [milan.trifunovic@masfak.ni.ac.rs](mailto:milan.trifunovic@masfak.ni.ac.rs), [milos.madic@masfak.ni.ac.rs](mailto:milos.madic@masfak.ni.ac.rs)

**Abstract:** The maximum profit rate is the main goal of metal processing industry and represents a natural criterion for determining the optimal cutting parameters. The determined optimal cutting parameters must at the same time satisfy constraints related to the required quality of the finished part, cutting tool, and machine tool. This paper describes the application of a deterministic approach, i.e., a Brute Force (BF) optimization algorithm, which guarantees the optimality of the optimization solutions, for solving multi-tool milling optimization problem. The profit rate was considered as objective function, while required power, surface roughness, and cutting force constraints were also included in the optimization model. The results and the values of constraints for optimal values of cutting parameters are compared with the results and the values of constraints from several studies which considered the same optimization problem.

**Key words:** multi-tool milling operations, optimization model, unit cost, unit time, profit rate

### Nomenclature

$A$  – chip cross-sectional area (mm<sup>2</sup>)  
 $a$ ,  $a_{rad}$  – axial depth of cut, radial depth of cut (mm)  
 $C$  – constant in cutting speed equation  
 $c_a$  – clearance angle of the tool (°)  
 $C_i$  ( $i = 1 - 8$ ) – coefficients carrying constant values  
 $c_l$ ,  $c_o$  – labour cost, overhead cost (\$/min)  
 $c_m$ ,  $c_{mat}$ ,  $c_t$  – machining cost, cost of raw material per part, cost of a cutting tool (\$)  
 $C_u$  – unit cost (\$)  
 $d$  – cutter diameter (mm)  
 $e$  – machine tool efficiency factor  
 $F$  – feed rate (mm/min)  
 $f$ ,  $f_{hb}$ ,  $f_{opt}$  – feed rate, recommended by handbook, optimum (mm/tooth)  
 $F_C$ ,  $F_{C(per)}$  – cutting force, permitted cutting force (N)  
 $F_F$ ,  $F_R$ ,  $F_T$  – feed, radial and tangential forces resulting from all active cutting teeth (N)  
 $G$ ,  $g$  – slenderness ratio, exponent of slenderness ratio  
 $K$  – distance to be travelled by the tool to perform the operation (mm)  
 $k_c$  – specific cutting force (N/mm<sup>2</sup>)  
 $K_i$  ( $i = 1 - 3$ ) – coefficients carrying constant values  
 $K_p$  – power constant depending on the workpiece material  
 $l_a$  – lead (corner) angle of the tool (°)  
 $m$  – number of machining operations required to produce the part  
 $N$  – spindle speed (rev/min)  
 $n$  – tool life exponent  
 $P$ ,  $P_m$  – required power for the operation, motor power (kW)  
 $P_r$  – profit rate (\$/min)  
 $Q$  – contact proportion of cutting edge with workpiece per revolution  
 $R$  – sale price of the product excluding material, set-up and tool changing costs (\$)  
 $R_a$ ,  $R_{a(at)}$  – arithmetic mean roughness, and attainable arithmetic mean roughness (µm)  
 $S_p$  – sale price of the product (\$)  
 $T$  – tool life (min)  
 $T_u$  – unit time (min)  
 $t_m$ ,  $t_s$ ,  $t_{tc}$  – machining time, set-up time, tool changing time (min)

$V$ ,  $V_{hb}$ ,  $V_{opt}$  – cutting speed, recommended by handbook, optimum (m/min)  
 $w$  – exponent of chip cross-sectional area  
 $W$  – tool wear factor  
 $z$  – number of cutting teeth of the tool

## INTRODUCTION

Economic considerations are obviously important in planning a machining process. The economics of machining considers three factors, namely: the production cost per component (the unit cost), the production time per component (the unit time) and the profit rate [1]. The maximum profit rate is the main goal of any industry, including metal processing industry, and represents a natural criterion for determining the optimal cutting parameters [2]. The determined optimal cutting parameters must at the same time satisfy constraints related to the required quality of the finished part, cutting tool, and machine tool. Traditionally, the selection of cutting parameters is based on the experience of the manufacturing engineers / machinists, recommendations from machining handbooks and cutting tool manufacturer recommendations, and results in values of cutting parameters which usually do not guarantee the maximization of the profit rate. Therefore, a number of researchers have tried to deal with the optimization of cutting parameters for maximizing profit rate in milling using different approaches.

Lee et al. [3] used the Nelder-Mead Simplex Method (NMSM) to optimize cutting speed and feed rate values in multi-tool milling operations. A novel version of Teaching-Learning-Based Optimization (TLBO) algorithm, TLBO with Dynamic Assignment learning strategy (DATLBO), was used by Zhai et al. [4] for the optimization of cutting parameters in multi-tool milling operations. An et al. [5] studied cutting parameter optimization problem for face milling operations and solved it using the Genetic Algorithm (GA). Optimal values of cutting speed and feed rate in multi-tool milling operations were determined by Yildiz using Cuckoo Search (CS) algorithm [6], and new hybrid approach based on Differential Evolution (DE) algorithm and receptor editing property of immune system [7].

Studies [3, 4, 6, 7] considered the already developed mathematical optimization model of Tolouei-Rad and Bidhendi [8]. Meta-heuristic algorithms were most often used for solving optimization problems in aforementioned studies. Although these heuristic methods have the advantages of easy implementation for complex problems, they cannot guarantee optimal solutions [9], even for a number of optimization runs [10], and parameters settings have a strong influence on the final solution [11]. The present study considers the mathematical optimization model of Tolouei-Rad and Bidhendi [8], and their optimization problem (case study) for multi-tool milling. The optimization problem was solved using a deterministic approach, i.e., a Brute Force (BF) optimization algorithm, which guarantees the optimality of the optimization solutions. Determined results and the values of constraints for optimal values of cutting parameters are compared with the results and the values of constraints from several studies which considered the same optimization problem.

## MATERIAL AND METHODS

The mathematical optimization model of Tolouei-Rad and Bidhendi [8] is considered in this study. It aims at determining the set of cutting parameters to maximize profit rate in multi-tool milling operations while considering several constraints. Since the depth of cut has the greatest effect on productivity, the goal is to perform the machining in one pass [2]. Therefore, the value of the depth of cut is defined in advance, so the problem of optimization of cutting parameters is then reduced to determination of optimal cutting speed and feed rate values. The case study is taken from the literature [8] for comparing the results and the values of constraints for optimal values of cutting parameters obtained using deterministic approach with other approaches.

## Objective function

The profit rate can be expressed as:

$$P_r = \frac{S_p - C_u}{T_u} \quad (1)$$

The unit cost for multi-tool milling operations can be expressed as:

$$C_u = c_{mat} + (c_l + c_o) \cdot t_s + \sum_{i=1}^m (c_l + c_o) \cdot K_{1i} \cdot V_i^{-1} \cdot f_i^{-1} + \sum_{i=1}^m c_{ti} \cdot K_{3i} \cdot V_i^{\frac{1}{n}-1} \cdot f_i^{\frac{w+g}{n}-1} + \sum_{i=1}^m (c_l + c_o) \cdot t_{tci} \quad (2)$$

The unit time for multi-tool milling operations can be expressed as:

$$T_u = t_s + \sum_{i=1}^m K_{1i} \cdot V_i^{-1} \cdot f_i^{-1} + \sum_{i=1}^m t_{tci} \quad (3)$$

## Constraints

In practice, possible ranges for the cutting speed and feed rate are limited by the required power, surface roughness, and cutting force constraints, as well as available feed rates and spindle speeds on the machine tool and cutting regimes recommended by cutting tool manufacturer.

The ultimate goal in machining is to attain as high as possible material removal rate while considering that the required power for the operation does not exceed the maximum available power of the machine tool:

$$C_5 \cdot V \cdot f^{0,8} \leq 1 \quad (4)$$

where,

$$C_5 = 0,78 \cdot K_p \cdot W \cdot z \cdot a_{rad} \cdot \frac{a}{60 \cdot \pi \cdot d \cdot e \cdot P_m} \quad (5)$$

The resulting arithmetic mean roughness  $R_a$  should not exceed the maximum attainable arithmetic mean roughness  $R_{a(at)}$ . The surface roughness constraint for end milling can be expressed as:

$$C_6 \cdot f^2 \leq 1 \quad (6)$$

where,

$$C_6 = \frac{318 \cdot (4 \cdot d)^{-1}}{R_{a(at)}} \quad (7)$$

The surface roughness constraint for face milling can be expressed as:

$$C_7 \cdot f \leq 1 \quad (8)$$

where,

$$C_7 = \frac{318 \cdot (\tan l_a + \cot c_a)^{-1}}{R_{a(at)}} \quad (9)$$

The total cutting force  $F_C$  resulting from the milling operation must not exceed the permitted cutting force  $F_{C(per)}$  that the tool can withstand. Therefore, the cutting force constraint can be expressed as:

$$C_8 \cdot f \leq 1 \quad (10)$$

where,

$$C_8 = \frac{k_c \cdot a \cdot z}{F_{C(per)}} \quad (11)$$

## CASE STUDY

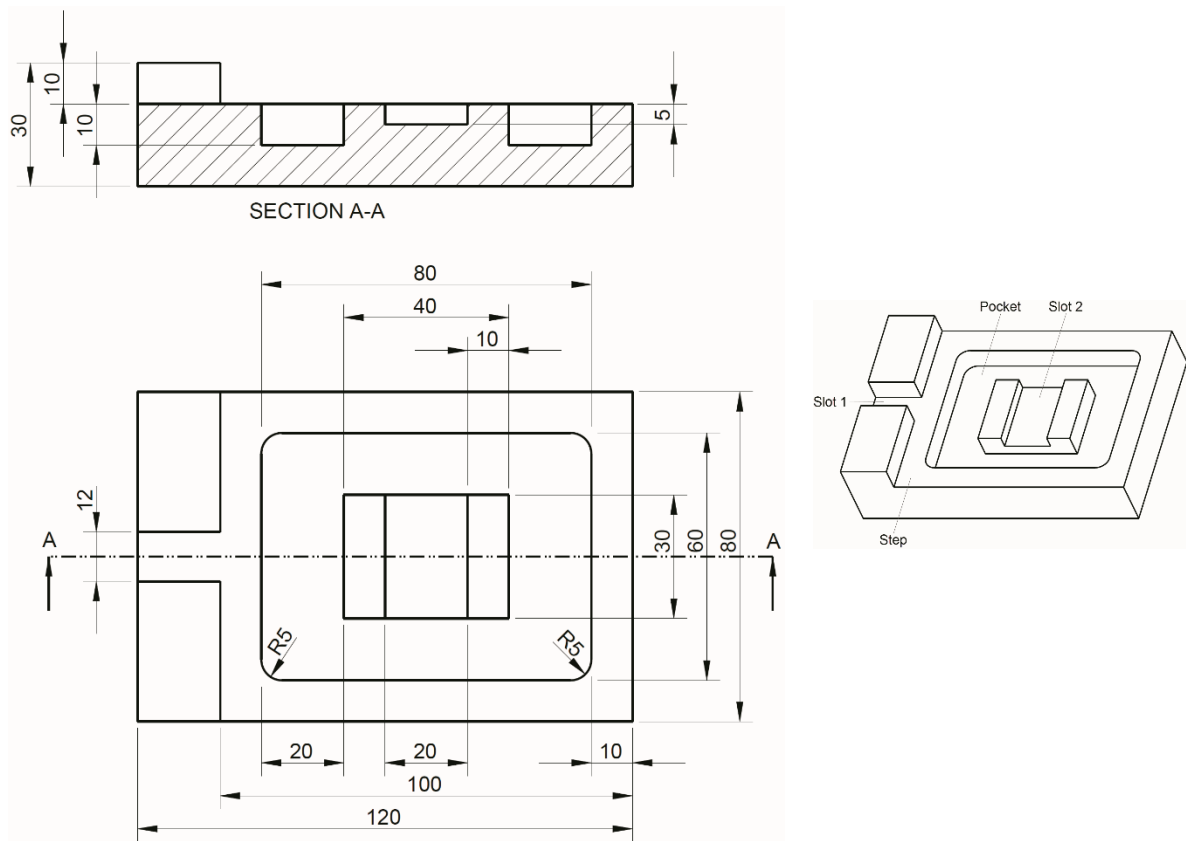
The finished part shown in Fig. 1 is to be manufactured using a CNC milling machine. The goal is to determine the cutting speed and feed rate values for each milling operation which result in the maximum profit rate and satisfy all the constraints at the same time. Specifications of the machine tool, workpiece material, and values of constants are given below.

Constants:

$S_p = \$25$	$t_{tc} = 0.5 \text{ min}$	$W = 1.1$
$C_{mat} = \$0.50$	$C = 33.98$ for HSS tools	$n = 0.15$ for HSS tools
$C_o = \$1.45$ per min	$C = 100.05$ for carbide tool	$n = 0.3$ for carbide tool
$C_l = \$0.45$ per min	$K_p = 2.24$	$g = 0.14$
$t_s = 2 \text{ min}$	$k_c = 1800 \text{ N/mm}^2$	$w = 0.28$

Machine tool data: vertical CNC milling machine,  $P_m = 8.5 \text{ kW}$ ,  $e = 95\%$

Workpiece material data: 10L50 leaded steel, hardness = 225 BHN



**Fig. 1.** Technical drawing of the finished part

As can be seen from Fig. 1, the workpiece includes four machining features: step, pocket and two slots. Operation 2 (corner milling) is added to remove the material from the corner of step remaining after face milling to produce a sharp corner. The required machining operations data and tools data are given in Table 1 and Table 2, respectively.

**Table 1.** Required machining operations data

Operation No.	Operation type	Tool No.	$a$ (mm)	$K$ (mm)	$R_{a(at)}$ ( $\mu\text{m}$ )
1	face milling	1	10	450	2
2	corner milling	2	5	90	6
3	pocket milling	2	10	450	5
4	slot milling	3	10	32	-
5	slot milling	3	5	84	1

**Table 2.** Tools data

Tool No.	Tool type	Quality	$d$ (mm)	$z$	Price (\$)	$l_a$ ( $^\circ$ )	$c_a$ ( $^\circ$ )
1	face mill	Carbide	50	6	49.50	45	5
2	end mill	HSS	10	4	7.55	0	5
3	end mill	HSS	12	4	7.55	0	5

Speed limits:

1. Face milling: 60 - 120 m/min
2. Corner milling: 40 - 70 m/min
3. Pocket milling: 40 - 70 m/min
4. Slot milling 1: 30 - 50 m/min
5. Slot milling 2: 30 - 50 m/min

Feed rate limits:

1. Face milling: 0.05 - 0.4 mm/tooth
2. Corner milling: 0.05 - 0.5 mm/tooth

3. Pocket milling: 0.05 - 0.5 mm/tooth
4. Slot milling 1: 0.05 - 0.5 mm/tooth
5. Slot milling 2: 0.05 - 0.5 mm/tooth

## RESULTS AND DISCUSSION

The optimization problem for multi-tool milling was coded and solved in the Brutomizer software tool [12] using the brute force algorithm. Values of cutting parameters (cutting speed and feed rate) are discretized by defining appropriate step sizes, in order to obtain practically feasible solutions that could be easily set on machine tool. In this way all possible candidates for the solution are enumerated. By checking whether each candidate satisfies the problem's statement, bruteforce algorithm guarantees the optimality of the solution for the given discrete search space.

The optimal values of cutting parameters for the operations used to produce the part, along with values of constraints are given in Table 3. Optimized machining cost and time for the operations used to produce the part are given in Table 4. Using the results in Table 4, the final unit cost, unit time, and profit rate are determined and given in Table 5.

**Table 3.** Optimal values of cutting parameters and values of constraints

Operation No.	Operation type	$V_{opt}$ (m/min)	$f_{opt}$ (mm/tooth)	$P$ (kW)	$R_a$ ( $\mu\text{m}$ )	$F_c$ (N)
1	face milling	120	0.07	6.445	1.791	7560
2	corner milling	70	0.47	8.213	1.756	16920
3	pocket milling	64	0.23	8.479	0.421	16560
4	slot milling	50	0.19	5.685	0.239	13680
5	slot milling	50	0.38	4.949	0.957	13680

**Table 4.** Optimized machining cost and time

Operation No.	Machining cost (\$)	Material and set-up costs (\$)	Tool changing cost (\$)	Machining time (min)	Set-up time (min)	Tool changing time (min)
1	2.760	4.3	0.95	1.402	2	0.5
2	0.448		0.95	0.021		0.5
3	1.010		0.00	0.240		0.0
4	0.070		0.95	0.032		0.5
5	0.116		0.00	0.042		0.0

**Table 5.** Unit cost, unit time and profit rate

Unit cost (\$)	Unit time (min)	Profit rate (\$/min)
11.554	5.238	2.567

The results (unit cost, unit time, and profit rate given in Table 5) and the values of constraints for optimal values of cutting parameters (given in Table 3) are compared with the results and the values of constraints from several studies which considered the same optimization problem [3, 4, 8, 13-17]. The comparison is given in Table 6.

**Table 6.** Comparison of results and values of constraints

Method	Unit cost (\$)	Unit time (min)	Profit rate (\$/min)	Power constraint satisfied~	Surface roughness constraint satisfied~	Cutting force constraint satisfied~
SS [13]	9.14* 8.646#	4.06* 4.095#	3.906* 3.994#	No#	No#	No#
PSO [14]	9.316*	4.089*	3.836*			



	8.646 <sup>#</sup>	4.088 <sup>#</sup>	4.000 <sup>#</sup>	No <sup>#</sup>	No <sup>#</sup>	No <sup>#</sup>
GA [15]	9.402 <sup>*</sup> 8.834 <sup>#</sup>	4.231 <sup>*</sup> 4.227 <sup>#</sup>	3.691 <sup>*</sup> 3.824 <sup>#</sup>	No <sup>#</sup>	No <sup>#</sup>	No <sup>#</sup>
NMSM [3]	8.6 <sup>*</sup>	4.76 <sup>*</sup>	3.45 <sup>*</sup>	Yes <sup>*</sup> No <sup>#</sup>	Yes <sup>*</sup> Yes <sup>#</sup>	Yes <sup>*</sup> Yes <sup>#</sup>
DATLBO [4]	9.82 <sup>*</sup> 8.670 <sup>#</sup>	4.61 <sup>*</sup> 4.083 <sup>#</sup>	3.31 <sup>*</sup> 3.999 <sup>#</sup>	No <sup>#</sup>	No <sup>#</sup>	No <sup>#</sup>
CS [16]	10.654 <sup>*</sup> 10.467 <sup>#</sup>	5.0373 <sup>*</sup> 5.038 <sup>#</sup>	2.848 <sup>*</sup> 2.885 <sup>#</sup>	No <sup>#</sup>	Yes <sup>#</sup>	No <sup>#</sup>
SFLA [17]	10.386 <sup>#</sup>	5.110 <sup>#</sup>	2.8095 <sup>*</sup> 2.860 <sup>#</sup>	Yes <sup>#</sup>	No <sup>#</sup>	No <sup>#</sup>
FD [8]	11.35 <sup>*</sup> 11.207 <sup>#</sup>	5.48 <sup>*</sup> 5.478 <sup>#</sup>	2.49 <sup>*</sup> 2.518 <sup>#</sup>	Yes <sup>*</sup> Yes <sup>#</sup>	Yes <sup>*</sup> Yes <sup>#</sup>	Yes <sup>*</sup> No <sup>#</sup>
Recommended by handbook [8]	18.36 <sup>*</sup>	9.40 <sup>*</sup>	0.71 <sup>*</sup>	Yes <sup>#</sup>	Yes <sup>#</sup>	Yes <sup>#</sup>
<b>BF</b>	<b>11.554</b>	<b>5.238</b>	<b>2.567</b>	<b>Yes</b>	<b>Yes</b>	<b>Yes</b>
FD – Feasible Directions, SS – Scatter Search, PSO – Particle Swarm Optimization, SFLA – Shuffled Frog Leaping Algorithm ~ For all operations used to produce the part * As reported, # According to optimization model from this study						

The values of constraints for optimal values of cutting parameters were reported in only two studies [3, 8]. In all the studies used for comparison [3, 4, 8, 13-17], at least one of the constraints was not satisfied according to optimization model from this study. Profit rate for the cutting regime representing the optimization solution in this study is increased by 361 % (1.857 \$/min) compared to the profit rate for the cutting regime recommended by the handbook [8], while satisfying all the constraints for all operations used to produce the part.

## CONCLUSION

The analysis of the obtained results leads to the following conclusions:

- Results confirm that profit rate can be significantly increased by optimizing the cutting parameters starting from the initial parameter hyper-space as recommended by cutting tool manufacturer. Profit rate can be increased by 361 % (1.857 \$/min).
- In situations when the cutting parameter values recommended by the cutting tool manufacturer violate one or more constraints, and therefore cannot be realised on the machine tool, the approach proposed in this paper can be used for determining optimal cutting parameter values resulting in maximum profit rate.
- The applied deterministic approach may be justified for solving milling optimization problems due to its effectiveness and ability to deal with a number of nonlinear constraints of the inequality and equality type and high-dimensional domains.
- Discretization of cutting parameter values in the applied optimization approach may be beneficial in order to encompass certain process planning issues as well as techno-technological limitations of machine tools (allowable spindle speed, feed rate, cutting speed) and cutting tools (for example, nose radius).

## ACKNOWLEDGEMENTS

This research was financially supported by the Ministry of Science, Technological Development and Innovation of the Republic of Serbia (Contract No. 451-03-47/2023-01/200109).

## REFERENCES

- [1] Grzesik, W.: *Advanced Machining Processes of Metallic Materials – Theory, Modelling, and Applications*, Second Edition, Elsevier, Amsterdam, 2016.
- [2] Cukor, G.: *Obrada metala rezanjem*, Sveučilište u Rijeci, Tehnički fakultet, Rijeka, 2021.
- [3] Lee, Y., Resiga, A., Yi, S., Wern, C., The Optimization of Machining Parameters for Milling Operations by Using the Nelder-Mead Simplex Method, *Journal of Manufacturing and Materials Processing*, Vol. 4, Article ID: 66, 22 pages, 2020.
- [4] Zhai, Z., Li, S., Liu, Y., Parameter Determination of Milling Process Using a Novel Teaching-Learning-Based Optimization Algorithm, *Mathematical Problems in Engineering*, Vol. 2015, Article ID: 425689, 14 pages, 2015.
- [5] An, L., Yang, P., Zhang, H., Chen, M., Multi-Objective Optimization for Milling Operations using Genetic Algorithms under Various Constraints, *International Journal of Networked and Distributed Computing*, Vol. 2, pp. 108-114, 2014.
- [6] Yildiz, A.R., Cuckoo search algorithm for the selection of optimal machining parameters in milling operations, *The International Journal of Advanced Manufacturing Technology*, Vol. 64, pp. 55-61, 2013.
- [7] Yildiz, A.R., A new hybrid differential evolution algorithm for the selection of optimal machining parameters in milling operations, *Applied Soft Computing*, Vol. 13, pp. 1561-1566, 2013.
- [8] Tolouei-Rad, M., Bidhendi, I.M., On the optimization of machining parameters for milling operations, *International Journal of Machine Tools and Manufacture*, Vol. 37, pp. 1-16, 1997.
- [9] Diyaley, S., Chakraborty, S., Optimization of multi-pass face milling parameters using metaheuristic algorithms, *Facta Universitatis, Series Mechanical Engineering*, Vol. 17, pp. 365-383, 2019.
- [10] Wang, Q., Liu, F., Wang, X., Multi-objective optimization of machining parameters considering energy consumption, *The International Journal of Advanced Manufacturing Technology*, Vol. 71, pp. 1133-1142, 2014.
- [11] Kovačević, M., Madić, M., Radovanović, M., Software prototype for validation of machining optimization solutions obtained with meta-heuristic algorithms, *Expert Systems with Applications*, Vol. 40, pp. 6985-6996, 2013.
- [12] Virtuode, Brutomizer, Available at <https://www.virtuode.com/index.php/products/brutomizer20/>
- [13] Gopala Krishna, A., Mallikarjuna Rao, K., Optimisation of machining parameters for milling operations using a scatter search approach, *The International Journal of Advanced Manufacturing Technology*, Vol. 31, pp. 219-224, 2006.
- [14] Baskar, N., Asokan, P., Saravanan, R., Prabhakaran, G., Optimization of Machining Parameters for Milling Operations Using Non-conventional Methods, *The International Journal of Advanced Manufacturing Technology*, Vol. 25, pp. 1078-1088, 2005.
- [15] Agrawal, A., Varma, S.N., Optimization of Machining Parameters for Milling Operations Using a Genetic Algorithm Approach, *International Journal of Engineering & Technology Research*, Vol. 3, pp. 38-43, 2015.
- [16] Singh, S.K., Mohanty, A.M., New Movement Strategy of Cuckoo Search Algorithm for achieving higher profit rate in Milling Operation, Available at SSRN: [https://papers.ssrn.com/sol3/papers.cfm?abstract\\_id=3976716](https://papers.ssrn.com/sol3/papers.cfm?abstract_id=3976716)
- [17] Gomez-Gonzalez, M., Jurado, F., Machining Parameters Selection for Milling Operations Using Shuffled Frog-Leaping Algorithm, *International Journal of Emerging Technology and Advanced Engineering*, Vol. 5, pp. 50-59, 2015.

## FUME EXTRACTION SYSTEMS FOR TEXTILE LASER CUTTING MACHINES

Ineta Nemeša<sup>1</sup>, Marija Pešić<sup>1</sup>, Borislav Stoyanov<sup>2</sup>, Valentina Bozoki<sup>1</sup>

<sup>1</sup>University of Novi Sad, Technical Faculty "Mihajlo Pupin", Zrenjanin, Serbia

<sup>2</sup>Technical university of Gabrovo, Bulgaria

e-mail: [inetavil@gmail.com](mailto:inetavil@gmail.com)

**Abstract:** Lasers are used to cut different materials also textiles. Laser cutting is highly accurate and can easily and precisely create complex shapes, it can also ensure very high productivity. The laser cutting process creates unwanted by-products - a variety of dust, smoke, and aerosols which are generated melting and evaporating cut textile materials. The by-products have to be extracted, filtered and discharged into the ambient air to ensure safe work process and environmental protection. Several parts of a laser cutting machinery are responsible for extraction gases and solid particulates: cutting gas, a cutting surface, an extraction system and filters. Cutting gas drives out the debris and molten material from a cut material kerf. By help of an extraction system the smoke particles and soiling are drawn away above and below the cut material. The filter system separates and removes coarse and fine dust particles and hazardous substances.

**Keywords:** laser cutting, textile cutting, extraction system, filter system, environmental protection

### INTRODUCTION

A number of different laser applications are designed for specific industrial use. Lasers are used to cut metals, stones, plastics, rubber, ceramics, leather, textiles and other materials. Laser-cutting systems (see Fig.1) are capable of a wide range of cutting and marking tasks, such as, through cutting, kiss cutting, perforating, drilling, engraving, marking, creasing, ablation, structuring, welding etc [1,2,3,4,5,6,7,11].



*Fig. 1. CO2 laser cutting machine XL-1600 by company Eurolaser*

Comparatively soft materials, such as wood, laminates, sheet metal, plastic films, sheet plastics, foamcore, paper, cardboard, leather and textiles use to be cut by carbon dioxide (CO<sub>2</sub>) lasers. The laser textile cutting method has several important advantages. As there is no physical contact between the cutting device and the material, very fragile materials and parts can be cut with little or no support and contaminants cannot enter or become embedded in the material. Light-weight fabrics can be cut by laser in high quality and very fast, often much faster than by knife cutting systems [8,9,10,11,13]. Laser cutting is highly

accurate and can easily and precisely create complex shapes. Laser power can be accurately controlled to perform different laser treatments on textiles by the same laser source: cutting, kiss cutting, engraving, marking, perforating. Laser cutting is tool-free processing that does not have extra costs related to the purchase and maintenance of cutting tools. There are no delays in the work process because of tool changing and replacement [6,11]. Many software improvements are incorporated into today's optimized laser cutting systems.

## **BY-PRODUCTS OF LASER CUTTING PROCESS**

Next to great advantages of laser cutting method comparing with a longtime used textile knife cutting method, there is also negative sides of it. The laser cutting process produces unwanted by-products - a variety of dust, smoke, and aerosols which are generated due to melting and evaporating cut materials of textile. In the industry these contaminants are known as Laser Generated Air Contaminants (LGACs). They can negatively impact cutting process quality and contaminate or even damage machinery and processed materials. Laser cutting dust impact on cutting efficiency and that is a serious concern. Dust could be so thick that it can diffuse the beam. This reduces the intensity of the beam and can interfere with the process. Also, maintenance costs for these processes can rise if dust is not extracted properly and regularly. By-products also can cause an environmental concern and pose a threat to the health of workers. People can become permanently sensitised to fumes which means that continued exposure, even to very small amounts of fume, may cause asthma attacks or other respiratory diseases. Dust created by laser cutting is a serious inhalation hazard. The intense heat involved in the process creates particulates in the sub-micron size; the smaller the particulate, the easier it is inhaled and absorbed into the human body [14]. Dusts might include particles of many different elements and molecules. Some of them are dangerous and the Occupational Safety and Health Administration (OSHA) [15] has issued separate worker exposure limits for each one. Fine dusts can be an ignition hazard, as well. Regulations for laser cutting dust "Permissible exposure limits" (PEL's) are set by OSHA to limit many individual toxic or nuisance dusts as well. These limits are measurements of how much of a substance a worker can be exposed to over an 8-hour shift.

Extraction of gases and solid particulates obtained melting, burning and evaporating cut materials is important part of the laser cutting process. In different applications ration in between them use to be different. For example, fume from nylon when treated by laser is roughly 80% particulate to 20% gas, whereas fume from acrylic is 90% gas to 10% particulate [16]. If the contaminants are simple nuisance dust, the filtration would be quite simple and inexpensive. However, if the dust contains one or more dangerous particulates, a filtration system would be capable of filtering that out of the air.

The by-products have to be constantly extracted and, depending on the application, filtered and discharged into the ambient air. Several parts of advanced laser cutting machinery are responsible for extraction of both gases and solid particulates, they are: cutting gas, a cutting surface and an extraction system of a laser cutter [6,11].

## **AUTOMATED LASER CUTTING SYSTEMS AND THEIR MAIN PARTS**

A laser system for textile cutting consists of: a laser source, an optical system to guide the laser beam, a laser cutting tool, computer-controlled machine axis to guide the laser tool, operational software, a work surface to support processed material and the extraction system to take away fumes and dust [3].

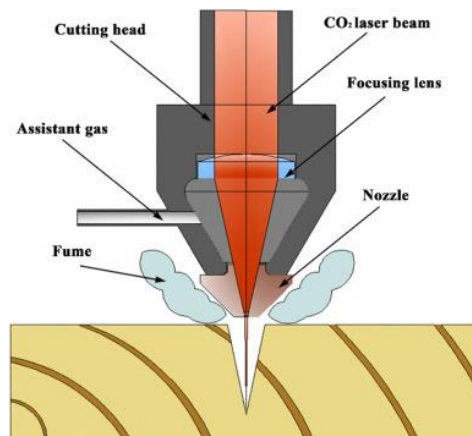
### **Laser cutting tool**

The laser beam is a column of very high intensity light of a single wavelength, or colour. In the case of a CO<sub>2</sub> laser it is infrared light at 10.6 microns. The most part of textile materials may be processed with 60-100 W lasers. However, there are some textiles, e.g., Aramid

(Kevlar), which is processed with 400 W lasers. During the cutting process, the light from a laser source is transferred by mirrors and delivered at the cut surface. As the intense beam of light strikes the material, its temperature rises, portions of it melts, burns, evaporates and by-products (fumes and dust) create [6,11,12].

### Cutting head (processing head)

The main parts of the cutting head are a focusing lens and a cutting nozzle. By help of the lens the laser beam is focused onto the material surface precisely for cutting or engraving. A cutting nozzle guides the stream of compressed air into the cutting gap to keep clean cut material edges and take away dust and fumes generated in laser cutting process (see. Fig.2).



*Fig. 2. Laser cutting head*

### Cutting surface

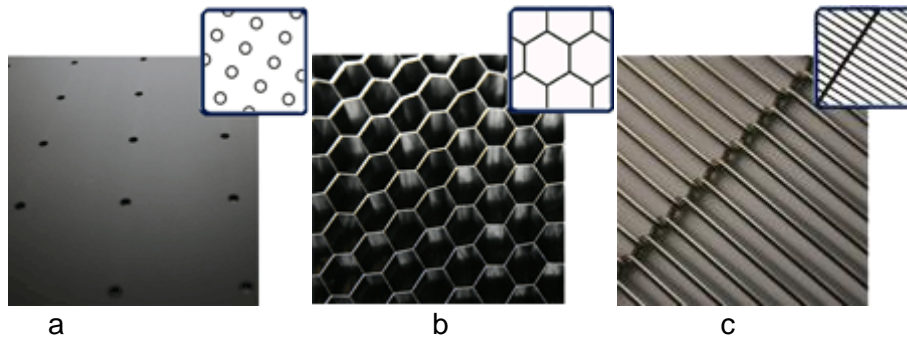
Both gantry and galvo laser systems perform laser treatment of the material on a specifically designed static or conveyORIZED work surface [11]. Processing flexible materials, such as textiles, a cutting surface has several functions: it has to keep the textile material flat and fixed during the work process, it has to minimize "reflection burns", as well as, it has to support the extraction system of the cutter to lead away the cutting emissions. Taking into account described functions of the cutting surface and the type of job to be performed, metal plates, perforated or not, and grid kind of working surfaces are used for processing textiles [6].

#### ***Metal plate***

Metal plate (perforated or not) is used on static tables to perform material engraving and marking when the laser beam effects only the top surface of the textile material and not going fully through it (see Fig.2). Very thin fabrics also can be cut on the metal plate because they require very low laser power. By use of surface perforation, vacuum/extraction system can keep the material fixed and evacuates the cutting emissions.

#### ***Metal grid***

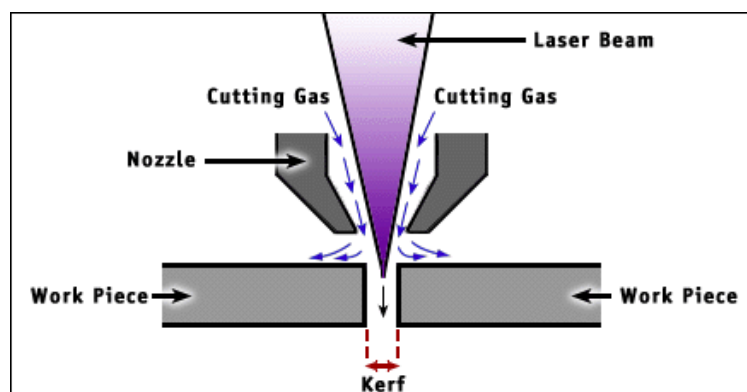
Using metal grid (in a shape of web, honeycombs, lamella, or other) the laser beam can pass cleanly through the cut material reducing underside reflections (which are the reason of burning of the back side of material). The grid kind of surface also provides free airflow under the cut material to exhaust cutting fumes easily from the work area avoiding deposition of debris on the reverse side of the cut material. Combined with an air suction system, the grid surface is ideal for cutting light, thin and unstable materials such as textiles.



**Fig. 3.** Cutting surfaces: perforated metal plate (a), honeycombs (b) and lamella (c)

### CUTTING GAS (SHIELD GAS, ASSIST GAS, PROCESS GAS)

During the work process, the laser beam heats, melts and partially or completely vaporizes the cut material. The stream of compressed gas (air or nitrogen) is led to the material through a cutting nozzle to drive out the dust and molten material from the cut kerf - the groove made while cutting (see Fig.4). Together with the compressed gas the dust it is vacuumed off downwards through the cutting gap and surface of the vacuum table. The gas also cools the heat-affected material zone and thus reduce cutting width, ensure uniform cut edges, minimize material oxidation marks on cut edges. Clean air is mostly used as the cutting gas for processing textiles [6].



**Fig. 4.** Cut material kerf

The cutting quality and extraction of dust and fumes are very much dependent on the pressure of the cutting gas. If the pressure is too low, the fluid slag can remain adhered to the cut material, forming a permanent burr or closing the kerf again. If the pressure is too high, the lower edges of the cut can be burnt out and often make the cut unusable. Cutting gas pressure has to be increased with the material thickness rise.

### EXTRACTION SYSTEMS

By help of special extraction system, the smoke particles and soiling created in the laser cutting process are drawn away above and below the material (see Fig.5). Properly positioned fume extraction also prevent or minimize underside marks caused by cutting structure of the table.



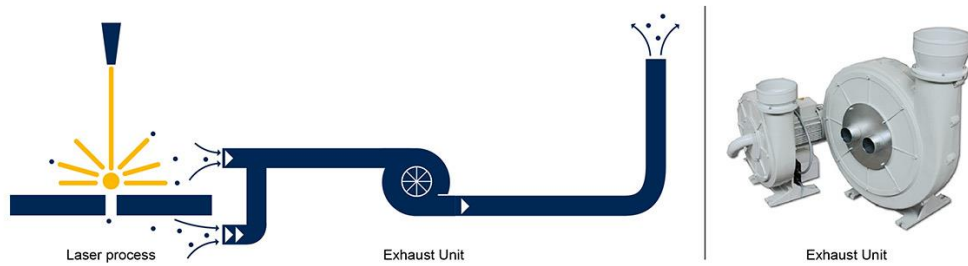


Fig. 5. Exhaust unit by company Eurolaser

## Extraction directions

### Lower extraction

A special air suction system located beneath the cutting surface collects cutting emissions and leads them away (Fig.6). Under the processed material ply it lowers pressure and ensures that thin, flexible materials lay on the cutting surface evenly, prevents cut materials from slipping and small cut parts from lifting. The level of the vacuum as well as the sections of the table that are exhausted can be adjusted individually depending on the treatment, material properties and size of the treated material ply. Lower extraction is proper mainly for gantry systems where the cutting tool is relocated over the significant processing area. Energy costs can be reduced by switching off segments that are not needed.

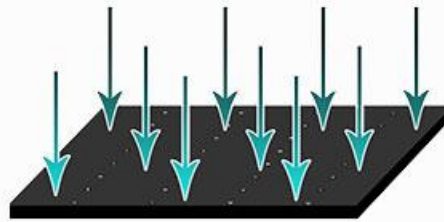


Fig. 6. Lower extraction system

### Upper and lateral extraction

Above the cut material the cutting emissions can be collected in two different ways: laterally or upwards. In the case of *lateral extraction* (see Fig.7a) ambient air with emissions is evacuated via lateral exhaust slots that are usually located at the rear. This extraction method has one disadvantage - the fumes which are dragged over the material surface can soil it causing marks. Using *upper extraction* (see Fig.7b) cutting emissions are collected around the laser beam directly upwards. Upper/lateral extractions very important when the functioning of the lower extraction unit is restricted or impossible, for example, performing through cutting on the metal plate, performing engraving and kiss cutting, when material is not completely cut through and performing denim finishing on mannequins.

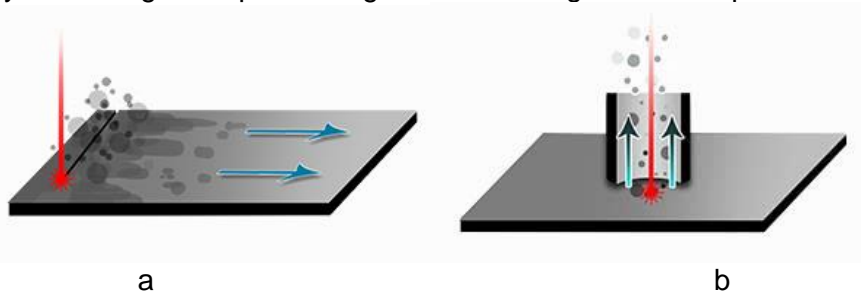
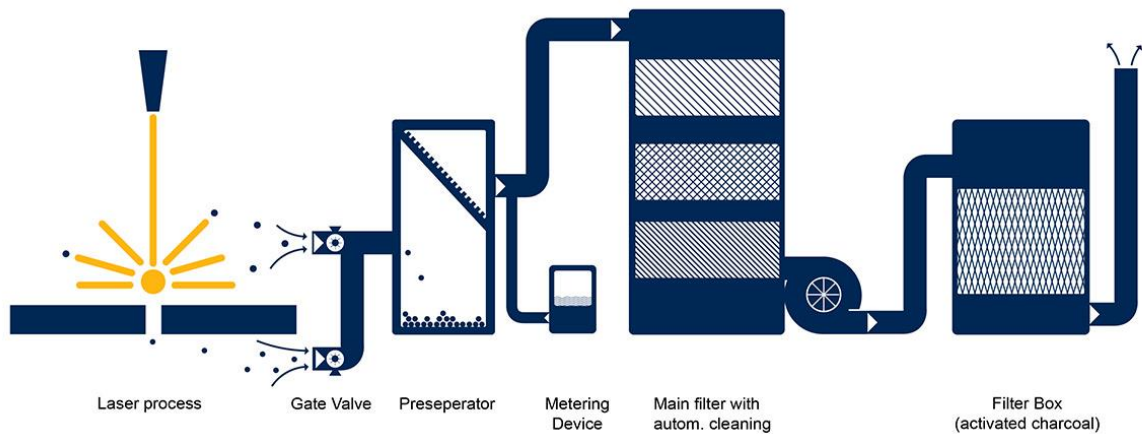


Fig. 7. Lateral extraction (a) and upper extraction (b)

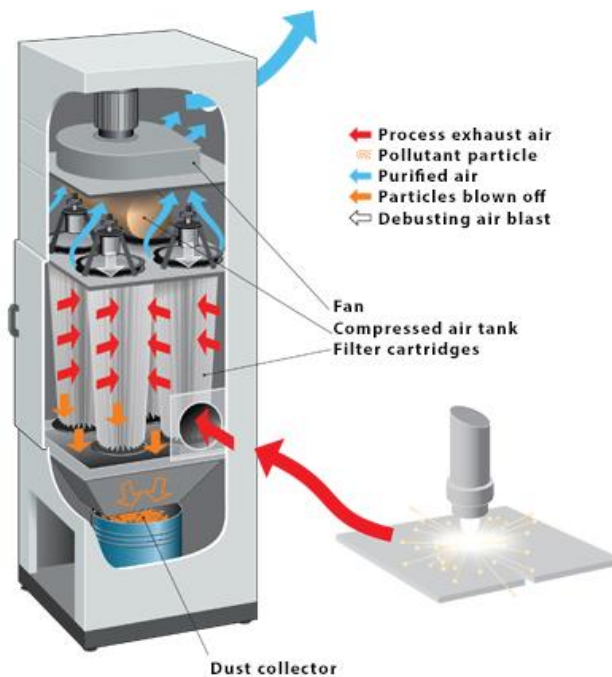


## Emissions filtering

To ensure reliable and safe work process and environmental protection, emissions arising from the thermal cutting process need to be extracted safely and if necessary filtered. The filter system separates and removes coarse and fine dust particles and hazardous substances. Hazardous substances, even from the gas phase, are removed using specially designed multistage filters (see Fig.8,9) [16,17]. The advantages of exhaust technology have an impact on cutting quality, cutting speed, material positioning, safety at work, environmental protection and particle filtering.



**Fig. 8.** Air extraction concept EFC by company Eurolaser



**Fig. 9.** Filtering system by Eurolaser

## CONCLUSIONS

Currently because of changes in the market and fast fashion dominance, ordered garment styles are manufactured in smaller quantities switching textile material cutting from automated multi-ply to single-ply cutting methods. Comparing with traditionally used knife cutting, the laser single-ply cutting can ensure higher productivity, cutting accuracy and other important advantages mentioned in the article. Producers of the automated laser cutting systems are constantly improving their equipment to ensure higher cutting quality and reduce by-product impact to cutting process, human health and environment.

## REFERENCES

- [1] Lawrence J.R., Pou J., Low D.K.Y. and Toyserkani E., *Advances in Laser Materials Processing*, 2nd edition. Woodhead, Elsevier, Cambridge, 2017.
- [2] Yuan, G. X., Jiang, S. X., Newton, E., Fan, J. T., & Au, W. M. Application of laser treatment for fashion design. *Journal of the Textile Institute*, 103, 48–54, 2012.
- [3] Nayak, R. and R. Padhye, The use of laser in garment manufacturing: an overview, *Fashion and Textiles*, Vol. 3(1): pp. 1-16, 2016.
- [4] Stoyanov B., Kr. Drumev, D. Genov, "Fashion design using laser engraving technology", *Journal of the Technical university of Gabrovo*, Vol.52, pp. 53-57, 2016
- [5] Yuan, G. X., Zhuoming Chen, Domenico Luzzi, Application of Laser Technology in Fashion Industry. In: Pui-Sze Chow, Chun Hung Chiu, Amy C. Y. Yip, Ailie K. Y. Tang. *Contemporary Case Studies on Fashion Production, Marketing and Operations*, pp 43-56., 2017.
- [6] Vilumsone-Nemes I, *Industrial cutting of textile materials*, 2nd edition, Woodhead Publishing, Elsevier, ISBN-9780857091345, Cambridge. 2018.
- [7] Nemeša I., Kaplan V., *Završna obrada tekstila laserom.*, *Tekstilna industrija*, br.1., 33-39, 2019.
- [8] Nemeša I., *Automated knife cutting systems to process textiles*, *Tekstilna industrija*, Vol.65/4, pp. 24-31, 2017.
- [9] Nemeša I., *Automatizovano krojenje mnogoslojnih krojnih naslaga*, *Tekstilna industrija*, Vo.66/1., 10-16, 2018.
- [10] Nemeša I., *Automatizovano jednoslojno krojenje tekstilnih materijala*, *Tekstilna industrija*, Vol.66/ 2., 23-29, 2018.
- [11] Nemeša I., *Automated laser cutting systems to process textiles*, *Tekstilna industrija*, Vol.66/4, pp.52-57, 2018
- [12] Nemeša I., Pešić M., Bozoki V., *Laser Parameters to Ensure Qualitative and Saved for Environment Denim Garment Finishing Process*, *Proceedings of the II International Conference on Physical Aspects of Environment ICPAE2023*, pp 101-108, Zrenjanin, 24 – 26th, August 2023.
- [13] Pešić M., Nemeša I., Bozoki V., *Laser Application in Textile and Apparel Industry*, *Proceedings of the II International Conference on Physical Aspects of Environment ICPAE2023*, pp 108-115, Zrenjanin, 24 – 26th, August 2023.
- [14] *Reducing a risk of laser cutting dust exposure*, available on: <https://www.robovent.com/industrial-dust-collection/laser-cutting>
- [15] *European standards*, available on: <https://osha.europa.eu/en/european-standards>
- [16] *Application-related filter concepts*, available on: <https://www.eurolaser.com/laser-systems/system-components/extraction-and-filter-concepts>
- [17] *Laser Generated Air Contaminates*, available on: <https://www.tlm-laser.com/laser-safety/bofa-laser-fume-extraction>



## ENHANCING TRAFFIC SAFETY AND EFFICIENCY THROUGH DEEP LEARNING-BASED IMAGE PROCESSING WITH TENSORFLOW IN TRANSPORTATION

**Dragan A. Milošević<sup>1</sup>, Dragoljub Ilić<sup>1</sup>, Mića Djurdjev<sup>2</sup>, Miroslav Vulić<sup>1</sup>**

<sup>1</sup> University Business Academy in Novi Sad, Faculty of Economics and Engineering Management in Novi Sad, University Business Academy in Novi Sad, Serbia  
e-mail: [dragan.milosevic@fimek.edu.rs](mailto:dragan.milosevic@fimek.edu.rs)

<sup>2</sup> Technical Faculty "Mihajlo Pupin" Zrenjanin, University of Novi Sad, Đure Đakovića bb, 23101 Zrenjanin, Serbia

**Abstract:** This paper explores the application of deep learning-based image processing with TensorFlow to enhance traffic safety and efficiency within the field of transportation. By leveraging the capabilities of TensorFlow, we address critical challenges such as the detection of in-car abandoned children, accident prevention, automatic number plate recognition, image classification of automobiles, traffic sign recognition for self-driving vehicles, and traffic density monitoring. Through a comprehensive review of related studies and real-world case studies, we demonstrate the effectiveness of these techniques in improving traffic management. The results highlight the potential for significant advancements in traffic safety and efficiency through deep learning technologies.

**Key words:** Deep Learning, TensorFlow, Traffic Safety, Transportation.

### INTRODUCTION

Traffic safety and efficiency are paramount concerns in the field of transportation, with the potential to save lives and reduce congestion. As the world becomes increasingly interconnected, the demand for smart solutions to these challenges has never been greater. This paper explores the promising avenue of utilizing deep learning, coupled with the powerful TensorFlow framework, to address these critical issues.

Deep learning, a subfield of artificial intelligence, has demonstrated remarkable capabilities in various domains, ranging from image and speech recognition to autonomous systems. It holds great promise for revolutionizing the transportation sector by enhancing safety and efficiency through image processing.

In this paper, we aim to provide an overview of the achievements of TensorFlow (TF) in the domain of transportation engineering today. We delve into the innovative applications of deep learning techniques to tackle traffic-related problems, drawing inspiration from a body of prior research.

### DEEP LEARNING AND TENSORFLOW

Deep Learning, a subset of machine learning, has emerged as a revolutionary technology with profound implications for various fields, including transportation. It is characterized by the use of artificial neural networks to model and solve complex problems. At the heart of deep learning are algorithms inspired by the structure and function of the human brain, which allow systems to automatically learn and improve from experience.

### Applications of Deep Learning

Deep learning has found applications in diverse domains, ranging from image and speech recognition to natural language processing. In the context of transportation, it has proven to be a game-changer, offering innovative solutions for enhancing traffic safety and efficiency.

## **TensorFlow: A Leading Deep Learning Framework**

TensorFlow has enabled the development of advanced image processing techniques. It facilitates the creation of neural network models that can analyze and interpret visual data from traffic cameras, sensors, and other sources. These models can detect patterns, identify objects, and make real-time decisions to enhance safety and efficiency on the road. In the context of transportation, it has proven to be a game-changer, offering innovative solutions for enhancing traffic safety and efficiency.

## **Frameworks for Transportation Solutions**

Besides TensorFlow, several other deep learning frameworks are instrumental in the development of transportation solutions. These include PyTorch, Keras, and Caffe, among others. Each framework offers unique advantages, and the choice often depends on specific project requirements.

## **Deep Learning's Role in Traffic Safety**

Deep learning models can be trained to recognize road signs, traffic signals, and pedestrian behavior, contributing to safer driving conditions. Moreover, they can assist in real-time accident detection and avoidance by analyzing data from in-car sensors and external sources.

## **Deep Learning's Contribution to Traffic Efficiency**

Efficiency in transportation is greatly improved through deep learning-based traffic management systems. These systems optimize traffic flow, reduce congestion, and enhance route planning by analyzing vast amounts of data from various sources, including GPS devices, traffic cameras, and smartphones.

## **LITERATURE REVIEW**

The Literature Review section serves as the cornerstone for understanding the existing body of knowledge and research related to our endeavor to enhance traffic safety and efficiency through deep learning-based image processing with TensorFlow in the domain of transportation. The incorporation of deep learning techniques, particularly with TensorFlow, into the transportation sector represents a pivotal stride towards tackling contemporary traffic challenges. The following review will delve into an examination of prior studies and research articles that encompass various facets of traffic safety, image processing, and deep learning. This discussion will pave the way for the subsequent sections of this paper to identify gaps in the existing body of knowledge and elucidate the contributions of our work.

Deep learning and TensorFlow play a pivotal role in the advancement of traffic safety and efficiency. Deep learning, as demonstrated by recent research, has shown remarkable capabilities in a variety of applications as late recognition or classification issues.

Image Classification of Automobiles Using Deep Learning in TensorFlow is a prominent area of research due to the recent increase in the number of automobiles, which has resulted in increased traffic levels, congestion, and traffic accidents. Among the challenges posed by traffic accidents, the identification of the make of a vehicle involved in an auto-crash situation is of considerable importance [1].

Previous studies have addressed this challenge, often relying on hardware-based systems [1]. One common approach is the use of Convolutional Neural Networks (CNNs) to predict and recognize the make of automobiles involved in accidents [1]. CNNs have demonstrated significant capabilities in identifying and classifying objects within images, making them a suitable choice for this task [1].

The importance of image classification in the context of traffic safety cannot be overstated. Accurate classification of vehicles involved in accidents allows for a more precise understanding of accident scenarios, which can inform various aspects of traffic safety and efficiency. However, it's important to note that image preprocessing techniques, although improved over the years, can still be sensitive to changes in the external environment and may experience decreased accuracy in unexpected conditions [1].

In the paper [2] the authors address the critical issue of automatic number plate recognition (ANPR) using advanced technologies such as TensorFlow and EasyOCR. ANPR plays a vital role in modern traffic management systems, particularly in densely populated countries like India. The system described in this research involves the detection of vehicle number plates through video processing with OCR technology, followed by the extraction of alphanumeric characters using various algorithms. The practicality of this system extends to the entrances of gated areas and college campuses, where it captures video, converts it into images, extracts text, and stores it in a database. While ANPR technology has proven valuable, it faces limitations such as poor image resolution, motion blur, lighting challenges, and obscured plates. The paper delves into the methodology used for license plate detection, OCR application, and text extraction, emphasizing the use of EasyOCR. The research showcases the potential of computer vision-based ANPR systems for enhancing security and traffic management, offering insights into the automation of license plate detection for various applications, including security and surveillance.

In recent years, the reliability of machine learning (ML) systems has become increasingly crucial, especially in safety-critical applications such as autonomous vehicles. To address this concern, various studies have proposed techniques for enhancing error-resilience in ML systems, with a focus on understanding the application's resilience. One notable contribution is the work [3], who introduced TensorFI 1 and TensorFI 2, high-level fault injection (FI) frameworks tailored for TensorFlow-based applications. These frameworks enable the injection of both hardware and software faults into TensorFlow 1 and 2 programs, offering configurability and flexibility. The research conducted with TensorFI 1 and TensorFI 2 involved the evaluation of 11 and 10 ML programs, respectively, shedding light on the factors contributing to the resilience of these models. Additionally, performance overheads were assessed, and four case studies were presented, showcasing the utility of these injectors in assessing the resilience of ML systems [3].

The paper [4] focuses on a pressing issue: child fatalities in vehicles due to unintentional abandonment. This problem has gained attention due to a rising number of such incidents, particularly in Malaysia, where eight cases occurred between 2018 and 2021. Existing safety systems rely on child car seats with built-in sensors, but they face challenges like obscured cameras and high costs. To overcome these limitations, the paper employs Convolutional Neural Networks (CNN) for automated detection of in-car-abandoned children. However, this task is complex due to diverse backgrounds, human behavior variations, and lighting conditions. The study aims to enhance vehicle safety, raise parental awareness, and prevent tragedies through CNN-based automation.

Figure 1 showcases a sample of the detection accuracy achieved using the testing model developed in reference [4]. The image illustrates the successful identification of in-car-abandoned children, demonstrating the model's effectiveness in recognizing and tagging children within vehicle environments.



*Fig. 1. Sample of detection accuracy using testing model [4]*

Traffic sign recognition is a vital component of self-driving vehicles, significantly influencing their safe and efficient operation. In this context, paper [5] presents an approach for traffic sign recognition using MatLab and TensorFlow, with a focus on the application in self-driving vehicles [5]. The proposed method employs deep learning techniques, particularly convolutional neural networks (CNNs), to detect and classify traffic signs. This literature review section discusses the key aspects and findings of Pal's work, highlighting its significance in the field.

Approach in paper [5] centers on leveraging the capabilities of deep learning, specifically CNNs, to enhance the accuracy and reliability of traffic sign recognition. The integration of MatLab and TensorFlow provides a practical framework for researchers and developers interested in implementing similar systems.

The key contributions of paper [5] include:

- Achieving high accuracy in recognizing and classifying traffic signs, as demonstrated through rigorous testing on a separate dataset.
- Ensuring robust performance under varying lighting conditions, perspectives, and traffic sign appearances, reflecting the model's adaptability to real-world scenarios.
- Enabling real-time traffic sign recognition, a crucial factor for seamless integration into self-driving vehicles.

In recent years, the field of intelligent traffic monitoring has witnessed remarkable progress, thanks to the integration of deep learning and image processing. Notably, research [6] has introduced an inventive approach to address the challenges in traffic management. Their system combines computer vision and deep learning, utilizing TensorFlow and Convolution Neural Network (CNN) to accurately detect and classify vehicles in real-time traffic scenarios. This innovative, cost-effective solution not only handles varying backgrounds but also holds promise for broader applications, including optimizing signal timings and guiding drivers through alternative routes. Overall, Neha et al.'s work marks a significant advancement in intelligent traffic monitoring, paving the way for future developments in this field.

The integration of artificial intelligence (AI) in the automotive sector, driven by the rise of electric vehicles and intelligent transportation systems, has seen remarkable progress [7]. AI and machine learning have ventured into diverse areas, encompassing driverless cars, automated parking, driver fatigue detection, and advanced driver assistance systems (ADAS) [7].

In a pivotal study [7], AI technology was harnessed to create an intelligent electromagnetic tracking vehicle. This involved transferring TensorFlow and Keras frameworks to an embedded platform, resulting in the development of a smart tracking car. Key components included the i.MX RT1064 processor, electromagnetic sensors, steering mechanisms, and neural network algorithms for training and operation.

A significant milestone in this research was the successful deployment of convolutional neural networks (CNNs) for electromagnetic tracking within the smart vehicle. This study illuminated the potential of AI-driven systems in automotive applications, shedding light on pivotal technologies and automation controls for future smart vehicle manufacturing. It lays a solid foundation for forthcoming innovations in practical smart vehicle design and development [7].

Paper [8] shows that cutting-edge methods for pothole recognition using neural networks on unmanned ground vehicles (UGVs) are promising significant advancements in traffic safety. UGVs excel in challenging terrains, while neural networks, particularly TensorFlow, offer efficient object recognition. The study compares Keras and TensorFlow, with TensorFlow's dual APIs standing out. Integrated into a UGV control website, these techniques effectively detect potholes. The experiment demonstrates high accuracy, with results displayed in detailed tables and graphs. TensorFlow-driven neural networks on UGVs present an innovative path for pothole recognition, crucial for enhancing traffic safety and efficiency [9].

Study [9] contributes to traffic estimation in smart cities, enhancing traffic safety and efficiency: Machine learning advancements have provided innovative solutions for smart cities, particularly in tackling traffic flow prediction. Accurate traffic forecasts are essential for urban development, given the growing volume of transportation data. Conventional prediction models struggle with real-world complexities. Deep learning, specifically Convolutional Neural Networks (CNN), Stacked Autoencoders (SAE), and Long Short-Term Memory (LSTM), has emerged as a promising solution.

Paper [10] delves into the realm of automotive manufacturing, specifically exploring the integration of deep learning techniques. It scrutinizes the architecture, models, and deployment intricacies associated with enhancing processes such as logistics in the automotive manufacturing sector. Several deep learning models have been meticulously designed and tested to augment the quality and efficiency of these processes. This review comprehensively assesses the architecture, datasets, and model performance metrics, shedding light on the transformative potential of AI and deep learning in the automotive industry.

## **DISCUSSION**

The findings presented in this paper underscore the transformative potential of deep learning-based image processing using TensorFlow in the domain of transportation. Through a review of prior studies and case examples, we've explored the capabilities of TensorFlow in addressing critical traffic safety and efficiency challenges.

The utilization of Convolutional Neural Networks (CNNs) for image classification has demonstrated remarkable accuracy in recognizing vehicles involved in accidents, aiding in a precise understanding of accident scenarios. However, we acknowledge that image preprocessing techniques may require further refinement to enhance performance in challenging conditions.

Automatic Number Plate Recognition (ANPR) systems, as discussed, play a pivotal role in modern traffic management, but they are not without limitations. The advancement of OCR technology, such as EasyOCR, presents a promising avenue for automation while addressing challenges like motion blur and obscured plates.

The research [9] on fault injection in TensorFlow-based applications sheds light on the importance of resilience in safety-critical systems. This work highlights the significance of understanding application resilience and its implications for safety.



Furthermore, the automated detection of in-car abandoned children through CNNs represents a critical contribution to vehicle safety. Such technology has the potential to save lives and prevent tragic incidents.

Traffic sign recognition using TensorFlow and MatLab offers real-time solutions for self-driving vehicles, ensuring safer and more efficient operations on the road. The adaptability of these models to varying conditions is a crucial factor in their effectiveness.

Intelligent traffic monitoring systems, integrating deep learning and image processing, hold significant promise for optimizing traffic flow and guiding drivers. The cost-effectiveness and scalability of these solutions make them invaluable for modern traffic management.

## CONCLUSION

In conclusion, this paper has delved into the transformative impact of deep learning-based image processing with TensorFlow in the domain of transportation. The integration of TensorFlow into traffic safety and efficiency applications has yielded substantial advancements.

Through our review of various studies, we've witnessed the power of deep learning in vehicle image classification, ANPR, fault resilience, and child safety. These technologies have the potential to reshape the landscape of transportation safety.

The implications are clear: the adoption of deep learning techniques, supported by TensorFlow, can lead to safer roads, reduced accidents, and more efficient traffic management. As we move forward, further research and development in this field hold the promise of even greater achievements.

This paper serves as a stepping stone, highlighting the transformative possibilities of deep learning in enhancing traffic safety and efficiency. It is our hope that this work inspires future research and innovation in the intersection of deep learning, TensorFlow, and transportation.

## REFERENCES

- [1] Adekunle, G.T., Aladeyelu, A.C., Image Classification Of Automobiles Using Deep Learning In Tensorflow. *Journal of Multidisciplinary Engineering Science and Technology (JMEST)*, Vol. 10, Issue 3, pp. 15818-15822, ISSN: 2458-9403, March 2023.
- [2] Burkpalli, V., Joshi, A., Warad, A. B., Patil, A., AUTOMATIC NUMBER PLATE RECOGNITION USING TENSORFLOW AND EASYOCR, *International Research Journal of Modernization in Engineering Technology and Science*, Volume 04, Issue 09, pp. 493-501, September 2022.
- [3] Lakshmy S., Renjith G., Meenakshi M. L., Adithya V., Mariya R. E., Vehicle Accident Detection and Prevention using IoT and Deep Learning, *Proceedings of the 2022 IEEE International Conference on Signal Processing, Informatics, Communication and Energy Systems (SPICES)*, pp. 55-62, THIRUVANANTHAPURAM, India, 10-12 March 2022.
- [4] Norman, M., Pauzi, M. F. M., Ismail, M. H., Mohamad, Z., Rahim, A., Mohd, F. A., & Shafri, H. Z. M., Detection of in-Car-Abandoned Children via Deep Learning, *IOP Conference Series: Earth and Environmental Science*, Volume 1051, *Proceedings of the 8th International Conference on Geomatics and Geospatial Technology (GGT 2022)*, pp. 012026, 25/05/2022 - 26/05/2022, Online. DOI: 10.1088/1755-1315/1051/1/012026.
- [5] Pal, S. K., TRAFFIC SIGN RECOGNITION FOR SELF-DRIVING VEHICLES: A MATLAB AND TENSORFLOW APPROACH, *International Journal of Computer Science & Information System*, Volume 08, Issue 06, pp. 1-4, June 2023.
- [6] Neha, A., Raghavi, M., Madhurashree, M., Ranjitha, M. M., & Annapurna, V. K., Traffic Density Monitoring Using Tensorflow. *EasyChair Preprint no. 10596*, 8 pages, Date: July 19, 2023. Available at <https://easychair.org/publications/preprint/RqWx>
- [7] Guo, Y., Wu, S., Wang, Y., Wen, C., Luo, L., Fu, Q., Application and Implementation of Artificial Intelligence Technology for Intelligent Vehicle, *Journal of Physics: Conference Series*, Volume 2508, 012049, 2023.



- [8] Alpert, M., Onyshchenko, V., Recognition of Potholes with Neural Network Using Unmanned Ground Vehicles, in Proceedings of the International Conference on Computer Science, Engineering and Education Applications (ICCSEEA 2022), pp. 209–220, City of the Conference, 2022.
- [9] A. N. Tripathi and B. Sharma, A Deep Review: Techniques, Findings and Limitations of Traffic Flow Prediction Using Machine Learning, in International conference on Advances in Materials and Manufacturing, ICAMMT 2022, pp. 21–33, 05 July 2023.
- [10] Luckow, A., Kennedy, K., Ziolkowski, M., Djerekarov, E., Cook, M., Duffy, E., Schleiss, M., Vorster, B., Weill, E., Kulshrestha, A., Smith, M.C., Artificial Intelligence and Deep Learning Applications for Automotive Manufacturing. In: Proceedings of the 2018 IEEE International Conference on Big Data (Big Data), pp. 55-62, Seattle, WA, USA, 10-13 IEEE. DOI: 10.1109/BigData.2018.8622357, December 2018.
- [11] Pang, B., Nijkamp, E., Wu, Y. N., Deep Learning With TensorFlow: A Review, Journal of Educational and Behavioral Statistics, Volume 45, Issue 2, DOI: <https://doi.org/10.3102/1076998619872761>, 2019.



## HARDNESS TEST OF 3D PRINTED SPECIMEN FROM ABS PLASTIC

**Dušan Jovanić<sup>1</sup>, Valentina Mladenović<sup>1</sup>, Ljubica Lazić Vulićević<sup>1</sup>**

<sup>1</sup>Technical College of Applied Sciences, Zrenjanin, Serbia

e-mail: [dusan.jovanic@vts-zr.edu.rs](mailto:dusan.jovanic@vts-zr.edu.rs)

**Abstract:** This paper presents the hardness testing of a specimen made by 3D printing using the material extrusion process with a filament of Acrylonitrile Butadiene Styrene (ABS) utilizing the Shore D scale method. ABS is the most commonly used material in 3D printing. One of the disadvantages of 3D printing is that the parts have much weaker mechanical characteristics and require testing to determine the functionality of the working part. According to ISO 17296-3: Additive technologies - General principles - Part 3: Main characteristics and corresponding test methods, hardness testing is provided for all groups of plastic parts.

Hardness testing of plastic materials is defined by the standard EN ISO 868: 2015 - Plastics and ebonite - Determination of hardness by indentation using a durometer (Shore hardness) and was performed with an digital durometer - hardness tester.

**Key words:** hardness testing, additive production, fused filament fabrication, Acrylonitrile Butadiene Styrene (ABS)

### INTRODUCTION

Due to the lower quality of the processed surface and weaker mechanical characteristics of Acrylonitrile butadiene styrene (ABS) parts obtained by 3D printing, it is necessary to determine the mechanical characteristics: hardness, tensile strength, impact strength, compressive strength, bending strength, fatigue strength, creep, aging, friction coefficient, resistance to shear and crack propagation, according to SRPS ISO 17296-3: Additive technologies - General principles - Part 3: Main characteristics and corresponding test methods.

This standard also defines the test categories for metal parts, plastic parts and ceramic parts and classifies them into three groups: group H (tests of functional parts that are highly safety-critical), group M (tests of functional parts that are not safety-critical) and group L: testing parts during construction or prototype parts. Hardness testing is provided for all these groups of plastic parts.

The goal of this work is to determine the hardness of the specimen made of Acrylonitrile Butadiene Styrene (ABS) plastic depending on the applied layer height in the shell and infill.

The hypotheses of the research are that the highest hardness of the specimen made of Acrylonitrile butadiene styrene (ABS) plastic is achieved at the 0.2 mm layer height both in the shell and in the infill, and that the best configuration setting layer height for ABS is from 0.1mm to 0.2 mm.

### ADDITIVE MANUFACTURING

Additive manufacturing can be divided according to ISO 17296-2:2017: Additive technologies - General principles - Part 2: Overview of process categories and filling, into the following: Vat photopolymerization - laser stereolithography (SLA) and full-layer illumination-based stereolithography (DLP-SLA, LCD-SLA); Material extrusion (FFF - Fused filament fabrication); Binder jetting; Material jetting; Powder bed fusion - procedures using laser (SLS, SLM, DMLS) and procedures using electron beam (EBM); Directed energy deposition (DED - Deposition of materials using directed energy) and Sheet lamination (LOM - Laminated object manufacturing, PSL).

## Material extrusion

The process of material extrusion (FFF - Fused Filament Fabrication or FDM - Fused Deposition Modeling, the trade name of the company Stratasys [10], uses solid thermoplastic material - filament, which is pushed through a heated nozzle, whose temperature depends on the type of polymer, and in a doughy-melted state it is applied to a heated or unheated build plate. Afterward, the material hardens and forms the desired piece, layer by layer.

The most important parameters that can be adjusted on a 3D printer for the process of extruding materials - FFF are: manufacturing speed, extrusion speed, the height of the applied layer in the shell and infill, and the temperature of the nozzle and build plate.

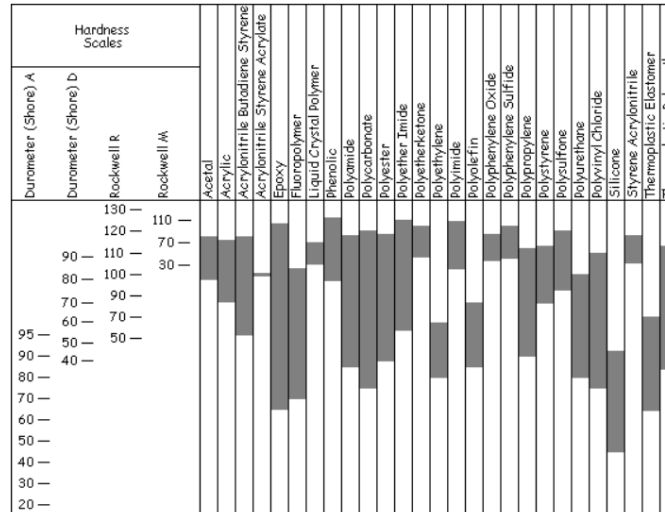
The main limitations of FFF are related to the anisotropic nature of parts. The layer-by-layer nature of FFF printing results in the parts that are fundamentally weaker in one direction.

The orientation during the printing process affects the strength in each direction. The infill percentage also has an effect on the strength of a part. Most printers produce parts and prototype with 20% infill which represents significant cost and time savings. However, a bracket subjected to loading requires a higher infill percentage (up to 100% or full infill). Higher levels of infill will result in a stronger part, but will increase build time and cost [1].

## ACRYLONITRILE BUTADIENE STYRENE (ABS)

There are a large number of polymers with different mechanical, physical, chemical and technological characteristics, which have a wide range of applications.. Hardness is a complex material mechanical property influenced by a variety of factors. Hardness comparison chart is shown in Table 1. Any conversions using this chart will be a rough estimate and should not be considered an exact conversion.

**Table 1. Hardness comparison chart [8]**



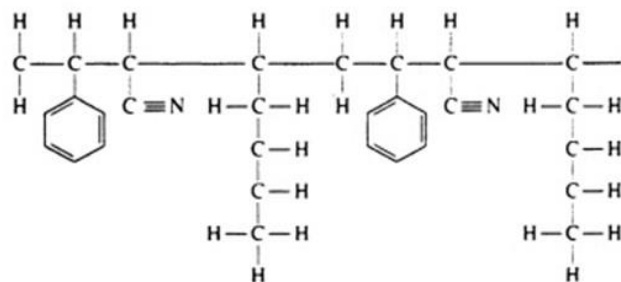
The mechanical characteristics of Acrylonitrile Butadiene Styrene - ABS are shown in Table 2. [9].

**Table 2. The mechanical characteristics of Acrylonitrile butadiene styrene (ABS)**

The parameters	Values
Elongation at Break	10 – 50 %
Elongation at Yield	1,7 – 6 %
Hardness Shore D	100
Strength at Break (Tensile)	29,8 - 43 MPa
Strength at Yield (Tensile)	29,6 - 48 MPa
Toughness (Notched Izod Impact at Room Temp.)	200 - 215 J/m

### 3D Printing

ABS is one of the most versatile materials available for 3D printing today. ABS comes in the form of a long filament wound around a spool. The 3D Printing process that uses ABS is the FDM (Fusion Deposition Modelling) process. The objects printed using ABS have slightly higher strength, flexibility, and durability. Finally, ABS can be recycled, just like many other thermoplastic polymers. Acrylonitrile Butadiene Styrene (ABS) is an impact-resistant engineering thermoplastic. ABS is composed of three monomers: acrylonitrile, butadiene, and styrene. These properties include high rigidity, resistance to impact, abrasion, and strain. It is used in electronic housings, auto parts, consumer products, pipe fittings, Lego toys, etc. ABS is produced by emulsion or continuous mass polymerization technique. The chemical formula of Acrylonitrile Butadiene Styrene is  $(C_8H_8 \cdot C_4H_6 \cdot C_3H_3N)_n$ . The molecular structure of Acrylonitrile Butadiene Styrene is shown on Fig.1 [9].

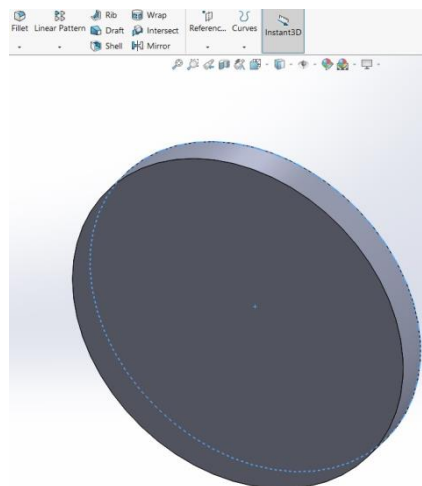


**Fig. 1.** The molecular structure of Acrylonitrile Butadiene Styrene [9]

### EXPERIMENTAL PART

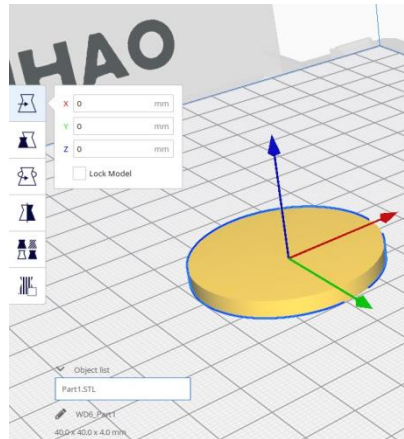
A series of experiments was conducted on cylindrical test specimens, with dimensions  $\phi 40 \times 4$  mm.

The 3D model (Fig. 2) was created in the SOLIDWORKS 2016 software package, and then converted into the appropriate STL file with the maximum resolution allowed by the software.



**Fig. 2.** The 3D CAD model of specimen

The STL file was imported via Ultimaker open-source Cura software, as shown in Fig. 3.



**Fig. 3.** The imported STL file of specimen

Subsequently, the relevant parameters were varied according to the experimental plan and a series of the specimen with the same external appearance but different characteristics was produced. The characteristics of Wanhao ABS filament are shown in Table 3.

**Table 3.** The features of Wanhao ABS filament

The parameters	Values
Filament type	ABS
Diameter (mm)	1.75
Melting point (°C)	220
Bed temperature (°C)	100 - 110
Extruder temperature (°C)	230-270

The technical characteristics of the Wanhao Duplicator 6 3D printer on which the specimens for the experiment were printed, are given in Table 4 [7].

**Table 4.** Wanhao Duplicator 6 3D Printer Technical Features

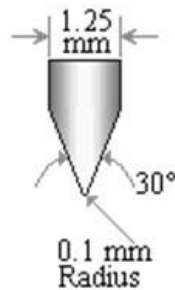
The parameters	Values
Materials	PVA, PLA, ABS, PEVA, HIPS
Max. part dimensions (mm)	200 x 200 x 180
Filament diameter (mm)	1.75
Nozzle outlet diameter (mm)	0.4
3D printing speed (mm/s)	30 - 150
Working temperature (°C)	180 - 260
Build plate temperature (°C)	50 - 100



**Fig. 4.** The 3D printer Wanhao Duplicator 6

## Procedure of hardness testing

The test specimen was placed on a hard, horizontal, plane surface. The durometer was held in a vertical position with the point of the indenter at least 9 mm from any edge of the test specimen. The recommended mass was 5 kg for the type D durometer. The scale of the indicating device was read after  $15\text{ s} \pm 1\text{ s}$ . Five measurements of hardness were taken at different positions on the test specimen, with a minimum separation of 6 mm, and the mean value was determined. A measure of the indentation resistance of elastomeric or soft plastic materials is based on the depth of penetration of a conical indenter (Fig.5). The hardness values range from 0 (for full penetration) to 100 (for no penetration) [2].



**Fig.5.** The Indenter Shore D [2]

As a measuring instrument, a durometer hardness meter YHD-SHORE D was used, following the Shore D scale, featuring a conical-shaped needle with a  $330^\circ$  angle, requiring a minimum specimen thickness of 4 mm and possessing an accuracy of 0.5 HS (D), as shown in Fig. 6.



**Fig. 6.** The device for measuring the hardness of ABS parts

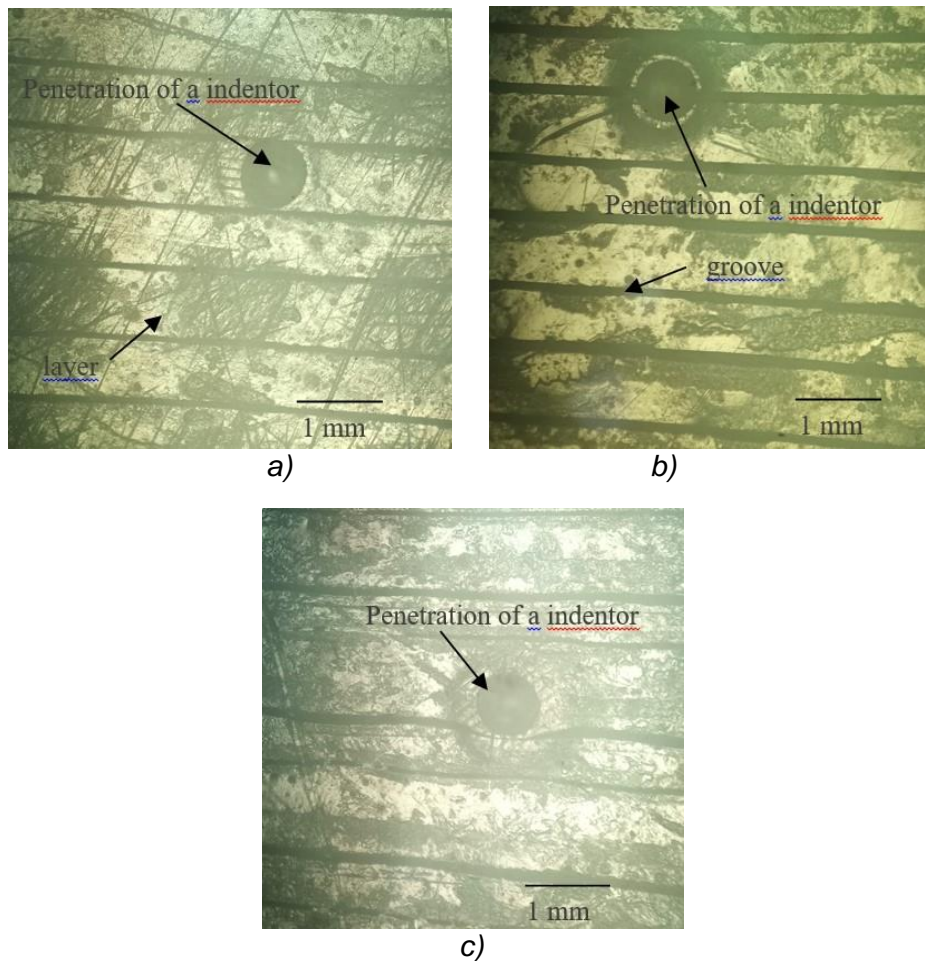
## RESULTS AND DISCUSSION

The surface quality of the specimen made of ABS plastic depends on the layer height applied in the shell and infill.

The lower the layer height applied, the higher the quality of the object and the greater the ability to perform details, but the production time increases nonlinearly.

Microscopic images of ABS objects with layer heights of 100, 200 and 400 microns, captured at 5x magnification, are shown in Fig.7.

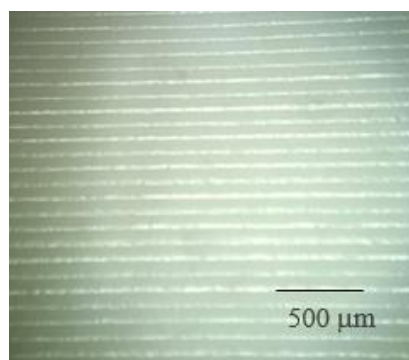




**Fig. 7.** A microscopic image of an ABS object with a layer heights of 100, 200 and 400 microns, taken at 5x magnification

In Fig. 7, the darker lines represent the grooves between the layers, which are areas of stress concentration. The wider these lines are, the rougher the surface. Microscopic inspection revealed that the width of the grooves greatest at the highest layer height applied. It can also be observed that the width of the groove (unfilled) is largest at the highest layer height applied. The measurement inaccuracy, even significant, occurs when the indenter hits in between the two layers, actually, when it hits the groove, as illustrated in Fig. 7 b).

A cross section of specimen and the number of layers for an application height of 0,1 mm are shown in Fig. 8.



**Fig. 8.** A cross-section of a layer with a layer height of 100 microns

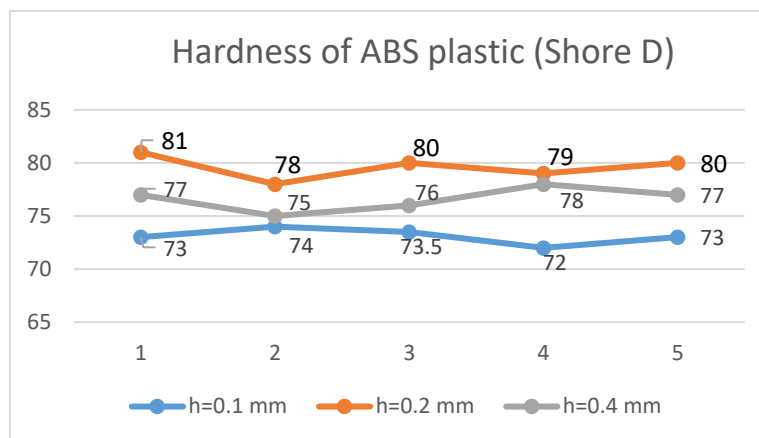


The hardness values, depending on the height of the applied layer with 100% infill, linear infill pattern, printing temperature of 250 °C, build plate temperature of 100 °C and printing speed of 30 mm/s, are shown in Table 5.

**Table 5.** The hardness values for different heights of the applied layer

Pattern	Layer height (mm)	Hardness HS (D)					Hardness HS (D)
		No 1	No 2	No 3	No 4	No 5	Main value
Lines	0.1	73	74	73,5	72	73	73,1
	0.2	81	78	80	79	80	79,6
	0.4	77	75	76	78	77	76,6

The hardness (HS-D) of the ABS plastic part depending on the height of the applied layer (h), as shown in Fig. 9.



**Fig. 9.** The hardness varies depending on the height of the applied layer

One of the main competitors of 3D Printing ABS is PLA. Unlike ABS, PLA is a renewably derived plastic. Similar to ABS, the hardness of PLA samples, produced using 3D printing with FFF technology, depends on the height of the applied layer. It is maximum for the smallest layer height and decreases almost linearly with increasing layer height during linear infill. The highest hardness of the specimen made of PLA plastic is achieved at the lowest layer height of 0.1 mm, with complete filling in the shell and infill, and decreases almost linearly according to the lowest hardness for the highest height at linear filling. The type of infill pattern does not significantly affect the hardness values because for all three types of filling (linear, zigzag and concentric) the hardness value is the same.

The heating of the build plate at the same infill and layer height has a slight effect, resulting in a 1% reduction in hardness. The hardness remains the same for the same layer height, regardless of the infill method used (linear, zigzag and concentric) [11].

The characteristics of Acrylonitrile Butadiene Styrene (ABS) as shown in Table 1, indicate that the hardness of ABS is from 55 HS (D) to 100 HS (D) [8].

The most accurate hardness test for 3D prints is the Shore test scale D, and the hardness value for 3D prints of ABS is 76.1 HS (D), with a difference between the maximum and minimum hardness of 8.08% [12].

## CONCLUSION

3D printing using the extrusion process with FFF technology, results in a low quality of the processed surface. From a hardness perspective, the hypotheses is confirmed that the highest hardness of the Acrylonitrile Butadiene Styrene (ABS) plastic specimen, measuring 79.6 HS (D), is achieved at the layer height of 0.2 mm in both, the shell and infill configuration. The optimal configuration for ABS is a layer height of 0.2 mm.

The darker lines represent the grooves between the layers and microscopic inspection has revealed that the width of the applied layer is greatest at the highest layer height.

It can also be observed that the width of the groove is largest at the highest layer height applied.

## REFERENCES

- [1] Redwood, B., Schöffer, F., Garret, B.: The 3D printing handbook: Technologies, Design and Applications, 3D Hubs, 2017.
- [2] EN ISO 868:2015- Plastics and ebonite - Determination of hardness by indentation using a durometer (Shore hardness)
- [3] SRPS EN ISO/ASTM 52900:2017 Aditivne tehnologije – Opšti principi – Terminologija
- [4] SRPS ISO 17296-2:2017: Aditivne tehnologije- Opšti principi- Deo 2: Pregled kategorija procesa i punjenje
- [5] SRPS ISO 17296-3: Aditivne tehnologije- Opšti principi- Deo 3: Glavne karakteristike i odgovarajuće metode ispitivanja.
- [6] Internet source: [www.wanhao3dprinter.com](http://www.wanhao3dprinter.com)
- [7] Internet source: <https://committee.iso.org/sites/tc261/home/projects.html>
- [8] Internet source: <https://plastics.ulprospector.com/properties/hardness-conversion-chart>
- [9] Internet source: <https://omnexus.specialchem.com/selection-guide/acrylonitrile-butadiene-styrene-abs-plastic>
- [10] Internet source: <https://www.stratasys.com/en/guide-to-3d-printing/technologies-and-materials/fdm-technology/>
- [11] Jovanić D., Mladenović V., Halas D.: Hardness test of 3D printed work piece from PLA plastic, ACTA TECHNICA CORVINIENSIS – Bulletin of Engineering Tome XVI [2023] | Fascicule 2 [April – JUNE]
- [12] Sikora P., Gnatowski A., Golebski R.: Tests of mechanical properties of semicrystalline and amorphous polymeric materials produced by 3D printing, MMS 2018 , MATEC Web of Conferences 254, 06003 (2019).



## PREDICTING SURFACE ROUGHNESS IN THE MILLING OF BIOCOMPATIBLE ALLOY Ti-6Al-4V

Igor Babić<sup>1</sup>, Lana Šikuljak<sup>1</sup>, Aleksandar Košarac<sup>1</sup>, Slaviša Moljević<sup>1</sup>, Milenko Sekulić<sup>2</sup>, Borislav Savković<sup>2</sup>, Anđelko Aleksić<sup>2</sup>

<sup>1</sup>University of East Sarajevo, Faculty of Mechanical Engineering, East Sarajevo

<sup>2</sup>University of Novi Sad, Faculty of Technical Sciences, Novi Sad

e-mail: [igor.babic2@gmail.com](mailto:igor.babic2@gmail.com), [ana.sikuljak@ues.rs.ba](mailto:ana.sikuljak@ues.rs.ba),  
[aleksandar.kosarac@ues.rs.ba](mailto:aleksandar.kosarac@ues.rs.ba), [slavisa.moljevic@ues.rs.ba](mailto:slavisa.moljevic@ues.rs.ba), [milenkos@uns.ac.rs](mailto:milenkos@uns.ac.rs),  
[savkovic@uns.ac.rs](mailto:savkovic@uns.ac.rs), [andjelkoa94@uns.ac.rs](mailto:andjelkoa94@uns.ac.rs)

**Abstract:** Mechanical engineering plays an essential role in the development of medical devices, implants, prostheses, and medical equipment, with precise machining of bio-compatible materials being of considerable importance. Among the various traditional and modern machining methods, milling stands out as a widely employed technique. This study is dedicated to optimizing milling parameters to achieve a minimal average surface roughness (Ra) during the milling of the biocompatible alloy Ti-6Al-4V. This paper presents the optimization of machining parameters: cutting speed, feed rate and depth of cut. Each parameter is explored at three distinct levels, resulting in the initial design of 27 experimental runs. The paper further demonstrates how an extensive set of experiments can be streamlined to a more manageable 9 runs through the application of the Taguchi methodology. This paper points out the significant impact that varying levels can exert on the obtained results, highlighting the importance of a comprehensive and systematic approach to experimentation and optimization.

**Key words:** Average surface roughness (Ra), difficult-to-cut materials, Ti-6Al-4V, ANOVA, Taguchi method

### INTRODUCTION

Ti-6Al-4V, also known as Titanium 6-4, holds significant importance in various industries, particularly in biomedical and aerospace applications. The chemical composition of Ti-6Al-4V is detailed in Table 1. Its significance lies in its exceptional combination of properties, including high strength-to-weight ratio, excellent corrosion resistance, and biocompatibility, making it an ideal choice for medical implants, aircraft components, and more.

To successfully machine this alloy, manufacturers often employ techniques such as milling, turning, and grinding, using carefully optimized cutting parameters, tool materials, and cooling/lubricating methods to achieve desired surface finishes while maintaining dimensional accuracy and minimizing tool wear.

Milling is a widely used method for cutting this material. To effectively mill this material, machinists typically adopt strategies that involve selecting appropriate cutting tools and cutting parameters, i.e. cutting speed, feed rate, and depth of cut. This approach helps manage the heat generated during machining, reduce tool wear, and achieve the desired surface quality. Furthermore, optimizing these milling parameters is crucial to attain precise and efficient machining results when working with Ti-6Al-4V, especially in applications where surface roughness is a critical factor.

Despite having three factors, each with three levels, the full factorial design initially entails 27 experimental runs. However, by employing the Taguchi methodology and an orthogonal array, the number of required experimental runs is efficiently reduced to 9.

*Table 1. Ti-6Al-4 chemical composition*

Ti-6Al-4	V	Al	Sn	Zr	Mo	C	Si
	4,22	5,48	0,0625	0,0028	0,05	369	0,0222

## Literature review

Milling is a widely used conventional machining method. This paper explores the influence of cutting speed, feed rate, and depth of cut on surface quality during the milling of Ti-6Al-4V alloy. Achieving optimal machining parameters is essential for enhancing material removal rates, extending tool life, and achieving surface quality. Numerous research studies have explored the effects of machining parameters on surface roughness.

Kosarac et al. [1] conducted an experiment following the Taguchi methodology, which involved 27 experimental runs. Their research identified feed rate as the most influential factor affecting the average surface roughness in machining Al7075. Using a dataset consisting of these 27 samples, they developed various neural networks to predict surface roughness. Their findings suggested that even with a relatively small dataset, neural networks could be effectively developed for this purpose.

Tesic et al. [2] used the Taguchi methodology to determine optimal machining parameters and analyze their impact on surface roughness during milling of Ti6Al4V alloys. Their analysis revealed that, when machining the bio-compatible titanium alloy Ti6Al4V, the speed of cutting had the most significant influence on the roughness of the machined surface, followed closely by the feed rate per tooth.

Sun et al. [3] have conducted a series of end milling experiments to comprehensively characterize the surface integrity at various milling conditions. Their experiments have shown that the milled surface shows the anisotropic nature, and the surface roughness increases with feed and radial depth of cut, while the cutting speed has less impact.

Rahman et al. [4] used Taguchi methodology and analysis of variance (ANOVA) to determine the significance of radial depth of cut on cutting force, tool life and surface roughness compared to that of cutting speed and feed rate during face milling of Ti6Al4V alloy. They used mono and multi objective optimizations of the response characteristics to determine the optimal input parameters, namely, cutting force, feed rate, and radial depth of cut. According to their analysis the most significant factor for surface roughness is the feed rate, while the cutting force and radial depth of cut have the most impact on tool life.

Bai et al. [5] experimented with the lubrication performance of different nanofluids in milling Ti6Al4V alloy. They investigated the lubrication performance in terms of milling force, surface roughness and morphology of the workpiece surface. Experimental results demonstrated that the Al<sub>2</sub>O<sub>3</sub> nanoparticle obtained the minimal milling force, followed by SiO<sub>2</sub> nanoparticle. The minimum surface roughness was obtained by the Al<sub>2</sub>O<sub>3</sub> nanofluid followed by SiO<sub>2</sub>, MoS<sub>2</sub>, CNTs, graphite and SiC in the given order of significance. Spherical Al<sub>2</sub>O<sub>3</sub> and SiO<sub>2</sub> nanoparticles improved the lubrication effect of base oil mostly and were more suitable as environment-friendly additives for the base oil compared with the others.

Shokrani et al. [6] investigated the effect of cryogenic cooling using liquid nitrogen on surface integrity of Ti6Al4V alloy in end milling operations. They experimented with super cold liquid nitrogen at -197 °C as a method of heat dissipation when end milling at various combinations of cutting parameters compared to dry and flood cooling. Surface roughness and microscopic surface integrity were investigated and the analysis indicated that cryogenic cooling has resulted in up to 39% lower surface roughness compared to dry cutting and 31% compared to flood cooling. The investigation indicated that cryogenic cooling considerably improves surface integrity in end milling Ti6Al4V alloy.

Danish et al. [7] experimented with dry milling of Ti6Al4V alloy at constant depth of cut while varying the cutting speed and feed rate to observe the effects of these parameters on tool wear. They used a coated carbide insert end mill as cutting tool to investigate its performance under dry machining conditions and to optimize the cutting parameters to machine Ti6Al4V. The results show that cutting speed has the most impact on tool life. Lower cutting speed increases shocking force and decreases tool life. The results also indicate that for fixed depth of cut, full endmill engagement with the workpiece creates constant chip thickness and evenly distributes the cutting force between the tool and workpiece thus limiting the effect of the feed rate on surface roughness.

Eyup et al. [8] conducted a series of face milling experiments using the Taguchi methodology to determine the optimal cutting parameters for milling cobalt-based alloy "Stellite 6". The evaluated milling parameters are feed rate, cutting speed and depth of cut, while the surface roughness was measured as result data. The settings of face milling parameters were determined using Taguchi experimental design method, while the results were evaluated using signal to noise ratio and analysis of variance (ANOVA) to determine the optimal parameters. Confirmation tests with the optimal levels of cutting parameters were carried out and demonstrated the effectiveness of Taguchi optimization method. The study shows that cutting speed, feed rate and depth of cut have significantly influenced surface roughness with 95% confidence level.

Athreya et al. [9] used the Taguchi method to optimize cutting parameters for face turning on mild steel. Cutting speed, feed rate and depth of cut were evaluated at three levels using an orthogonal L9 Taguchi experiment array. After conducting the experiments the surface roughness was measured and Signal to Noise ratio was calculated. Optimal parameters were calculated and confirmation experiments were carried out, while the results were compared with the full factorial method. They conclude that the Taguchi method of experimental setup can be used to evaluate and optimize different parameters with high levels of confidence. It is also concluded that on face turning mild steel the most significant factor for surface roughness was the cutting speed, followed by depth of cut and feed rate.

Kumar et al. [10] experimented with hard turning of Ti6Al4V alloy using a carbide insert tool. The experiments were conducted by varying 4 parameters on 3 levels using the Taguchi L9 orthogonal matrix for experimental design. The evaluated parameters were nose radius, depth of cut, feed rate and cutting speed while the surface roughness was measured. Their experiments show that for dry turning of Ti6Al4V the most significant parameter on tool wear and surface roughness is the nose radius of the cutting tool insert, followed by feed rate, depth of cut and cutting speed.

Kumar et al. [11] investigated the effect of cutting parameters on surface roughness when turning AISI 1045 carbon steel. They used Taguchi method for experimental setup and an L27 orthogonal array for three parameters on three levels, cutting speed, feed rate and depth of cut. Using the analysis of variance method (ANOVA) they concluded that the most significant parameter affecting surface roughness when turning AISI 1045 is the feed rate with 95% significance.

## **EXPERIMENTAL SETUP**

In the pursuit of optimizing machining parameters and surface roughness in the milling of the biocompatible alloy Ti-6Al-4V, a comprehensive experimental setup was employed. This setup incorporated several components, each playing a role in the precision and effectiveness of the machining process.

### **Machine Tool**

All experimental runs were performed under identical machining conditions and using the same machine tool. The experiment was carried out using the Emco Concept Mill 250 machining center. With a maximum RPM of 10,000 and a power rating of 7 kW, this machine tool provided the necessary mechanical force and precision for the milling operation.

### **Cutting Tool**

The choice of cutting tool was the Pramet indexable end mill cutter model HF 16E2R030A16-SBN10-C, outfitted with two BNGX 10T308SR-MM:M8345 inserts designed explicitly for alloy cutting.

## Measurement Tools

The average surface roughness (Ra) was measured using a Mitutoyo SJ-210 measuring device, ensuring accurate and consistent data collection. For this experiment, measuring parameters are set according to the expected value of the Ra to  $\lambda_f = 2.5 \mu\text{m}$ ,  $\lambda_c = 0.8 \text{ mm}$ ,  $\lambda_n = 4 \text{ mm}$ .

## Machining Process

The milling operation was performed on sample parts measuring  $30 \times 30 \times 20$ , clamped in a general-purpose milling vise. Employing the climb milling method, material was removed from both sides of the sample parts. Notably, the sample parts were fed along the cutter's direction of rotation, a strategic choice to enhance the overall quality of the machined surface.

For the purpose of this research, two experiments were conducted, each comprising 9 experimental runs, planned by Taguchi Design of Experiments (DOE). Two factors, namely cutting speed and radial depth of cut, were set at consistent levels in both experiments, while the level of feed rate varied between the two sets of experiments. The objective was to assess the impact of the range of levels for this factor on the prediction of average surface roughness.

The axial depth of cut (ap) remained constant throughout the experiment, consistently set at half of the cutting edge length. In contrast, the radial depth of cut (ae) was subject to variation during the experimental process. The arithmetic mean roughness was measured on the peripheral side of the workpiece. For all experiments, wet machining was conducted using the semi-synthetic fluid BIOL MIN-E, which conforms to the ISO 6743/7 quality standard. Experimental factors and their levels for both experiments are provided in Table 2 and Table 3.

**Table 2.** Experimental factor and their levels for experiment 1

Factor	Level		
	1	2	3
Cutting speed (m/min)	60	80	100
Feed rate per tooth (mm/tooth)	0.05	0.075	0.1
Radial depth of cut (mm)	0.3	0.6	0.9

**Table 3.** Experimental factor and their levels for experiment 2

Factor	Level		
	1	2	3
Cutting speed (m/min)	60	80	100
Feed rate per tooth (mm/tooth)	0.15	0.25	0.35
Radial depth of cut (mm)	0.3	0.6	0.9

The rpm used in the experiment (1200 rpm, 1600 rpm, 2000 rpm) were calculated based on adopted upper and lower cutting speed (Table 2 and Table 3). The feed rate per minute is calculated using the determined rpm, feed per tooth value and number of inserts of end mill. The minimum feed rate ( $f_{\text{min}} = 120 \text{ mm/min}$ ) corresponds to the smallest number of revolutions ( $n_1 = 1200 \text{ rpm}$ ) and the lowest value of feed per tooth ( $f_{z1} = 0.05 \text{ mm/tooth}$  – Experiment 1). The maximum feed rate ( $f_{\text{max}} = 1400 \text{ mm/min}$ ) corresponds to a maximum rpm ( $n_3 = 2000 \text{ rpm}$ ) and maximum feed per tooth ( $f_{z3} = 0.35 \text{ mm/tooth}$  – Experiment 2).  $f$

## TAGUCHI METHOD FOR OPTIMIZATION OF CUTTING PARAMETERS

The influence of different factors on the surface quality was determined by conducting an experiment. Full factorial plan means conducting the maximum number of experimental runs,

determined by the factor and levels number. That means much longer time and a higher cost of the experiment. The Taguchi method is one of the most commonly used methods in the designing of the experiments. This method assume fewer experimental runs in compare to the full factorial plan. The main goal of this method is defining a minimum number of the experimental runs, which will contain an optimal combination of the factors and their levels. Data analysis is subsequently based on statistical methods. It determines the optimal conditions, in order to obtain a minimum of the cost function. The Taguchi optimization method is often used to obtain low surface roughness in various cutting operations. A measure of quality characteristics, the signal-to-noise ratio, is observed. The signal-to-noise ratio represents a deviation from the desired value. For the optimization of static problems, there are three signal-to-noise ratios: smaller is better, bigger is better and nominal is the best. The goal of this experiment was the determination of the arithmetical mean roughness (Ra), and the selected S/N ratio of interest corresponded to the "Smaller is better" criterion. In this case, a full factorial experiment entailed  $3^3 = 27$  experimental runs. Using the Taguchi method, the experiments were reduced from 27 runs to 9 runs by means of an orthogonal design. The orthogonal matrix shown in Table 4 and Table 5 has 9 rows, representing the number of experimental runs.

$$\frac{S}{N} = -10 \log \left( \frac{1}{n} \sum_{i=1}^n y_i^2 \right)$$

**Table 4.** Experimental plan –  $L_{27}$  orthogonal array (Taguchi method) – Experiment 1

Number of Trials	Cutting Speed (m/min)	Feed per Tooth (mm/tooth)	Depth of Cut (mm)	Replicate			Average $R_a$ ( $\mu\text{m}$ )	S/N ratio (dB)
				$R_{a1}$ ( $\mu\text{m}$ )	$R_{a2}$ ( $\mu\text{m}$ )	$R_{a3}$ ( $\mu\text{m}$ )		
1	60	0.05	0.3	0.437	0.32	0.482	0.413	7.68
2	60	0.075	0.6	0.623	0.53	0.404	0.519	5.696
3	60	0.1	0.9	0.854	1,81	0.709	0.781	2.141
4	80	0.05	0.6	0.466	0.366	0.38	0.404	7.872
5	80	0.075	0.9	0.601	0.616	0.722	0.646	3.790
6	80	0.1	0.3	0.483	0.456	0.52	0.486	6.261
7	100	0.05	0.9	0.387	0.401	0.413	0.413	7.951
8	100	0.075	0.3	0.373	0.516	0.414	0.434	7.243
9	100	0.1	0.6	0.701	0.549	0.589	0.613	4.250

**Table 5.** Experimental plan –  $L_{27}$  orthogonal array (Taguchi method) – Experiment 2

Number of Trials	Cutting Speed (m/min)	Feed per Tooth (mm/tooth)	Depth of Cut (mm)	Replicate			Average $R_a$ ( $\mu\text{m}$ )	S/N ratio (dB)
				$R_{a1}$ ( $\mu\text{m}$ )	$R_{a2}$ ( $\mu\text{m}$ )	$R_{a3}$ ( $\mu\text{m}$ )		
1	60	0.05	0.3	0.787	0.697	0.714	0.732	2.701
2	60	0.075	0.6	0.797	0.85	0.777	0.808	1.851
3	60	0.1	0.9	1.012	1.085	1.315	1.137	-1.117
4	80	0.05	0.6	0.716	0.712	0.521	0.649	3.746
5	80	0.075	0.9	0.766	0.953	0.813	0.844	1.473
6	80	0.1	0.3	0.874	1.036	0.859	0.923	0.695
7	100	0.05	0.9	0.445	0.426	0.391	0.420	7.521
8	100	0.075	0.3	0.413	0.51	0.546	0.489	6.201
9	100	0.1	0.6	0.969	0.929	0.875	0.924	0.683



The last column in Table 3 and Table 4 contains the S/N values based on measuring the obtained Ra values, using the "Smaller is better" criterion and taking into consideration Equation (1). Based on S/N, it is possible to find out which parameters are the most influential in regard to the arithmetical mean roughness value, Ra. An arithmetic mean roughness (Ra) table for cutting speed, feed per tooth, depth of cut was created in an integrated manner and the results are presented in Table 5 and Table 6. A greater S/N value corresponds to better performance. Therefore, the optimal level of the arithmetic mean roughness (Ra) for the experiment 1 is the level with the greatest S/N value, obtained at cutting speed 100 m/min (level 3), feed per tooth 0.05 mm/tooth (level 1), depth of cut 0.3 mm (level 1). In the same time, optimal level of the Ra for the experiment 2 is obtained at cutting speed 100 m/min (level 3), feed per tooth 0.05 mm/tooth (level 1), depth of cut 0.9 mm (level 3).

The optimization of the studied factors concerning the "Smaller is better" criterion provided the optimal combination, coded as 3-1-1 for the first experiment, and 3-1-3 for the second experiment. Since the 3-1-1 combination does not exist in the orthogonal array, a confirmation experiment needed to be conducted. The experimentally obtained value of Ra for the 3-1-1 combination of input parameters was Ra = 0.389  $\mu\text{m}$ , which confirms the results obtained when applying the presented method, Table 8.

The combination 3-1-3 is present in the orthogonal array in experiment 2, obviating the need for a confirmation experiment.

**Table 6.** S/N ratio of the arithmetic mean roughness Ra – Experiment 1

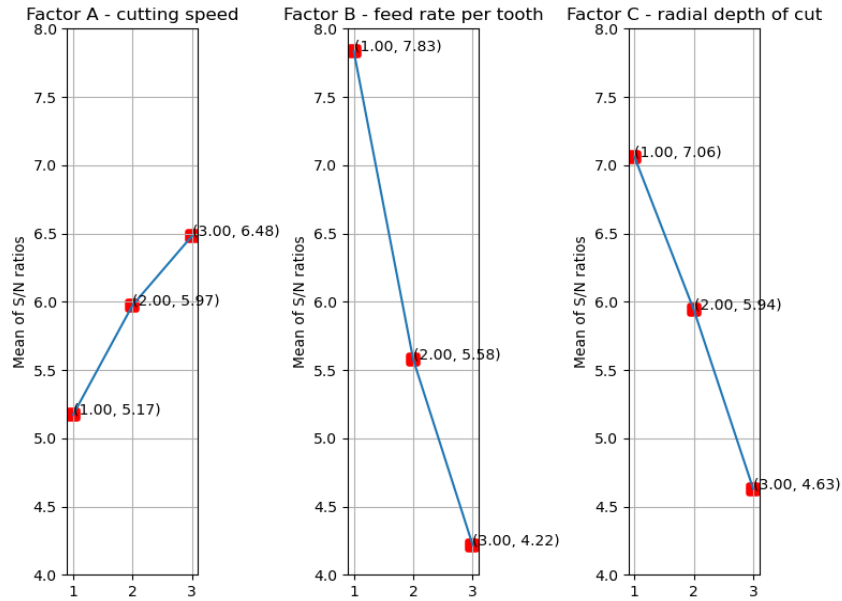
Factors	Level			Delta	Rank
	1	2	3		
Cutting speed	5.173	5.975	6.482 *	1.309	3
Feed per tooth	7.835 *	5.577	4.218	3.617	1
Radial depth of cut	7.062 *	5.940	4.628	2.434	2

\*Optimal level

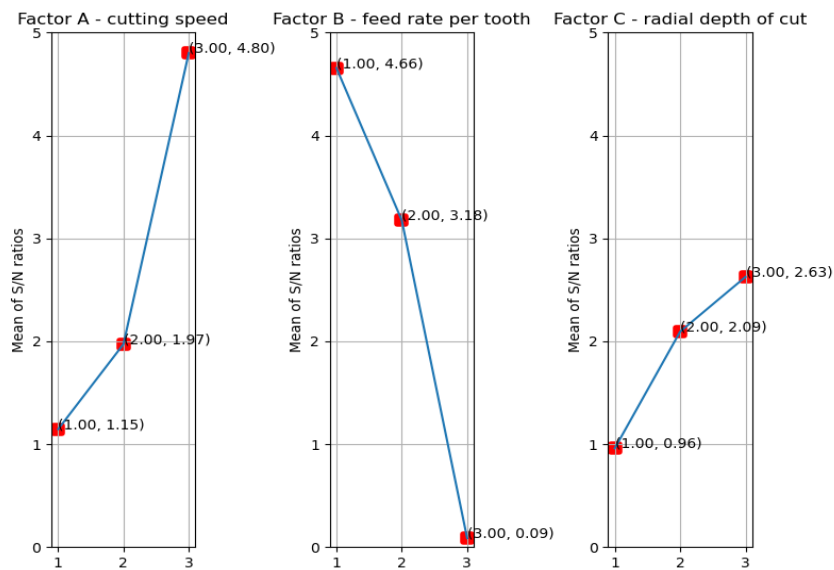
**Table 7.** S/N ratio of the arithmetic mean roughness Experiment 2

Factors	Level			Delta	Rank
	1	2	3		
Cutting speed	1.145	1.972	4.802 *	3.65	2
Feed per tooth	4.656 *	3.176	0.087	4.56	1
Radial depth of cut	0.960	2.094	2.626 *	1.66	3

\*Optimal level



**Fig. 1.** Main effect plot for S/N ratio – experiment 1

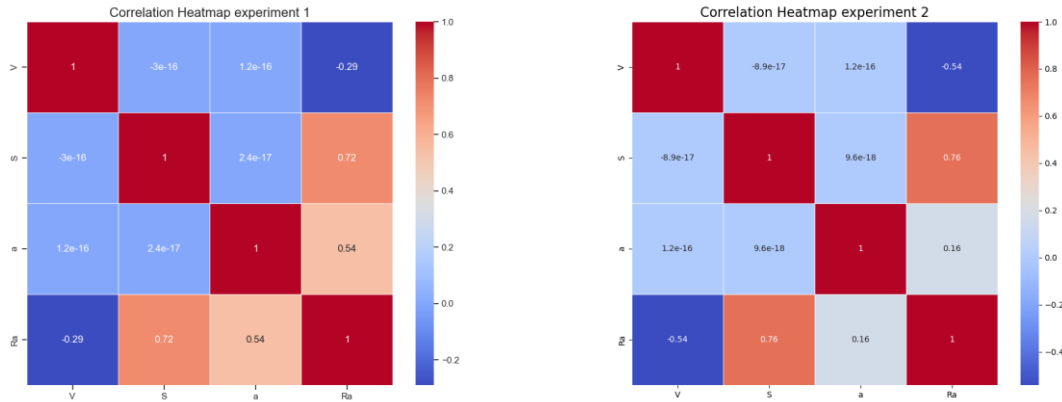


**Fig. 2.** Main effect plot for S/N ratio – experiment 2

**Table 8.** Confirmation experiment for combination 3-1-1

	Speed	Feed per tooth	Radioo depth of cut	S/N	Ra calculated	Ra test
Level	100	0,05	0,3	7.191	0.436	0.389

The graphical representation of the relationship between input variables, including cutting speed, feed rate, and depth of cut, alongside the output variable, average mean roughness (Ra), is effectively conveyed through Figure 3 in the form of a correlation matrix. Within this figure, the left section represents Experiment 1, while the right section depicts Experiment 2.



**Fig. 3.** Correlation matrix of cutting speed, feed rate, and depth of cut to mean average roughness Ra for experiment 1 (left) and experiment 2 (right)

To analyze the correlation matrix results, it will be explored the following insights.

- 1. Feed Rate Dominance:** In both experiments, the correlation matrix indicates that feed rate has the most significant positive impact, as it has the largest positive value. This suggests that changes in feed rate have a substantial influence on the output variable, Ra.
- 2. Positive Correlation with Feed Rate:** The positive correlation between feed rate and Ra is highlighted by the positive value in the correlation matrix. This indicates that as the feed rate increases, the Ra value tends to increase as well. In other words, there is a direct relationship between feed rate and surface roughness (Ra).
- 3. Negative Correlation with Cutting Speed:** The negative value in the correlation matrix for cutting speed aligns with expectations. It signifies that cutting speed and Ra are inversely related. As cutting speed increases, Ra tends to decrease. This finding is consistent with the well-known principle that increasing cutting speed often results in a smoother surface finish (lower Ra).

### ANALYSIS OF VARIANCE (ANOVA)

ANOVA is a statistical technique used to test the significance of the main factors comparing a mean square to an estimate of the experimental error at a certain level of confidence. In this study, the arithmetic mean roughness Ra obtained experimentally was analyzed using ANOVA. Analysis of variance illustrates the degree of importance of each factor that prominently influenced the arithmetic mean roughness Ra. Table 9. and Table 10. show the ANOVA results for the arithmetic mean roughness Ra for both experiments.

**Table 9.** Results of ANOVA for the arithmetic mean roughness experiment 1

Factor	DoF	Sum of squares	Variation	F-test
Cutting speed	2	0.012	0.006	0.918
Feed rate	2	0.074	0.037	5.558
Depth of cut	2	0.041	0.021	3.097
Error	2	0.01	0.007	
Total	8	0.137		

**Table 10.** Results of ANOVA for the arithmetic mean roughness experiment 2

Factor	DoF	Sum of squares	Variation	F-test
Cutting speed	2	0.124	0.062	5.94
Feed rate	2	0.246	0.123	11.818
Depth of cut	2	0.013	0.007	0.650
Error	2	0.020	0.010	
Total	8	0.4154		

The magnitude of the F-test for "Factor A" (cutting speed) in Experiment 1 is observed to be less than 1, similarly, the magnitude of the F-test for "Factor C" (depth of cut) in Experiment 2 is also found to be below 1. This suggests that these specific values hold limited statistical significance. As a result, a reevaluation of the inclusion of "Factor A" in Experiment 1 and "Factor C" in Experiment 2 has been conducted. After their exclusion, the F-test values were recalculated, and the results are presented in Table 11 and Table 12.

**Table 11.** Results of the final ANOVA for the arithmetic mean roughness experiment 1

Factor	DoF	Sum of squares	F-test	Percentage
Feed rate	2	0.0611	5.796	43.50%
Depth of cut	2	0.0284	3.230	20.22%
Error	4	0.0510		36.28%
Total	8			100%

**Table 12.** Results of the final ANOVA for the arithmetic mean roughness experiment 2

Factor	DoF	Sum of squares	F-test	Percentage
Cutting speed	2	0.107	7.208	26.38%
Feed rate	2	0.229	14.320	56.62%
Error	4	0.068		17.00%
Total	8			100%

Based on the F distribution tables, the ratios corresponding to 95% and 99% confidence levels are  $F_{0.05, 2,4} = 6.9943$  and  $F_{0.01, 2,4} = 18.000$ .

Both factor in Table 11. show physical and statistical insignificance corresponding to both confidence levels. Furthermore, the error value is notably elevated, standing at 36.28%.

In the same time factors presented in table 12 shows physical and statistical significance corresponding to both confidence level, 95% and 99%.

## CONCLUSIONS

This study was dedicated to optimizing milling parameters for achieving minimal average surface roughness (Ra) during the machining of the biocompatible alloy Ti-6Al-4V. The investigation entailed optimizing cutting speed, feed rate per tooth, and radial depth of cut, where each parameter was examined at three distinct levels. This comprehensive approach resulted in a full factorial design comprising 27 experimental runs.

A significant aspect of this research was the application of the Taguchi methodology, which allowed for the streamlining of the extensive set of experiments from 27 runs to a more manageable 9 runs. The study underscores the profound impact that varying parameter

levels can have on obtained results, emphasizing the importance of a comprehensive and systematic approach to experimentation and optimization.

Observations on Factor Levels:

**Experiment 1:**

Experiment 1 investigates cutting speed, feed rate per tooth, and radial depth of cut with the following levels:

- Cutting Speed (m/min): 60, 80, 100;
- Feed Rate per Tooth (mm/tooth): 0.05, 0.075, 0.1;
- Radial Depth of Cut (mm): 0.3, 0.6, 0.9

Notably, all factors in Experiment 1 were found to be statistically insignificant, with physical and statistical insignificance observed at both the 95% and 99% confidence levels. This suggests that, within the range of levels tested, variations in cutting speed, feed rate per tooth, and radial depth of cut did not significantly affect the average surface roughness (Ra) in Experiment 1. Furthermore, the high error rate of 36.28% underscores the complexity of achieving minimal Ra under these conditions.

**Experiment 2:**

In Experiment 2, the same factors were explored, with one notable difference in the range of feed rate per tooth:

- Cutting Speed (m/min): 60, 80, 100;
- Feed Rate per Tooth (mm/tooth): 0.15, 0.25, 0.35;
- Radial Depth of Cut (mm): 0.3, 0.6, 0.9

Experiment 2 yielded different results. Here, all factors demonstrated both physical and statistical significance at both the 95% and 99% confidence levels. This indicates that, with the altered range of feed rate per tooth, variations in cutting speed, feed rate per tooth, and radial depth of cut had a substantial impact on achieving minimal Ra. Although the error rate decreased to 17%, it remained relatively high, underscoring the challenges in optimizing these parameters.

In summary, this study reveals the critical role that a comprehensive approach to experimentation and optimization plays in understanding and improving machining processes. While Experiment 1 indicated insignificance and a high error rate, Experiment 2 showed significance, particularly due to the altered range of feed rate per tooth. These findings emphasize the importance of carefully selecting factor levels when seeking optimal machining parameters. Further research may explore additional factors and levels to refine the optimization process.

*"Funding: This paper presents a portion of the research results from the project „Advanced Processing Technologies of Modern Engineering Materials“, No. 142-451-334/2023-01/2, which is being carried out as part of the 'Financing of Joint Research Projects of Scientific Research Organizations' initiative, jointly funded by the Autonomous Province of Vojvodina and scientific research organizations from the Republic of Srpska in 2023."*

## REFERENCES

- [1] Kosarac,A., Mladjenovic,C., Zeljkovic,M., Tabakovic,S., Knezev,M.: Neural-Network-Based Approaches for Optimization of Machining Parameters Using Small Dataset, MDPI, Materials, 2022
- [2] Tešić, S., Zeljković, M., Čiča, Đ.: Optimizacija i ispitivanje uticaja parametara rezanja na hrapavost obrađene površine pri glodanju biokompatibilne legure - Ti6Al4V, TEHNIKA – MAŠINSTVO 68 (2019) 5
- [3] Sun, J., Guo, Y.B.: A comprehensive experimental study on surface integrity by end milling Ti–6Al–4V, Journal of Materials Processing Technology 209 (2009) 4036–4042
- [4] Rahman, Al Mazedur, Rob,S.,M.,A., Srivastava,A.,K.: Modeling and optimization of process parameters in face milling of Ti6Al4V alloy using Taguchi and grey relational

- analysis, f49th SME North American Manufacturing Research Conference, NAMRC 49, Ohio, USA, *Procedia Manufacturing* 53 (2021) 204–212
- [5] Bai, X., Li, C., Dong, L., Yin, Q.: Experimental evaluation of the lubrication performances of different nanofluids for minimum quantity lubrication (MQL) in milling Ti-6Al-4V, *The International Journal of Advanced Manufacturing Technology* (2019) 101:2621–2632
- [6] Shokrani, A., Dhokia, V., Newman, S., T.: Investigation of the effects of cryogenic machining on surface integrity in CNC end milling of Ti-6Al-4V titanium alloy, *Journal of Manufacturing Processes* 21, 2016, 172-179
- [7] Danish, N., H., D., Musfirah, A. H.: Optimization of Cutting Parameter for Machining Ti-6Al-4V Titanium Alloy, *JOURNAL OF MODERN MANUFACTURING SYSTEMS AND TECHNOLOGY (JMMST)*, e-ISSN: 2636-9575, VOL. 6, ISSUE 1, 53 – 57, DOI: <https://doi.org/10.15282/jmmst.v6i1.7465>, 2022
- [8] Eyup B, Aykut S, A study of taguchi optimization method for identifying optimum surface roughness in CNC face milling of cobalt-based alloy, *The International Journal of Advanced Manufacturing Technology*, vol. 29, no. 9-10, pp. 940-947, 2006.
- [9] Athreya S, Venkatesh Y. D, Application Of Taguchi Method For Optimization Of Process Parameters In Improving The Surface Roughness Of Lathe Facing Operation, *International Refereed Journal of Engineering and Science (IRJES)*, vol. 1, no. 3, pp. 13- 19, November 2012.
- [10] Kumar R. S. M, Kumar K. S, Analysis of Hard Machining of Titanium Alloy by Taguchi Method, in *Advanced Materials, Manufacturing, Management and Thermal Science*, 2016.
- [11] Kumar, P., Sharma, M., Singh, G., Singh, R. P.: Experimental investigations of machining parameters on turning of Ti6Al4V: optimisation using Taguchi method, *International Journal on Interactive Design and Manufacturing (IJIDeM)*, 2023

## THE CURRENT STATE OF ART ON MICROFORMING

**Jelica Anić<sup>1</sup>, Mladimir Milutinović<sup>2</sup>, Milija Krašnik<sup>1</sup>, Slaviša Moljević<sup>1</sup>**

<sup>1</sup>University of East Sarajevo, Faculty of Mechanical Engineering, East Sarajevo, B&H

<sup>2</sup>University of Novi Sad, Faculty of Technical Sciences, Novi Sad, Serbia

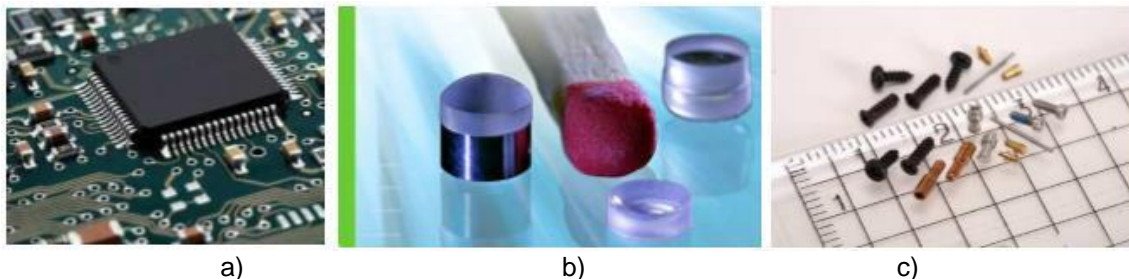
e-mail: [jelica.anic@ues.rs.ba](mailto:jelica.anic@ues.rs.ba)

**Abstract:** The growing utilization of micro parts in various industries has resulted in a notable upsurge in micro production. This trend is especially prominent in sectors such as automotive, aerospace, electronic component manufacturing, and medical device production. This paper gives an overview of researches conducted in certain areas of microforming, including micro deep drawing, micro hydroforming, micro incremental sheet forming, micro extrusion, micro bending, and micro tensile testing.

**Key words:** micro forming, micro sheet forming, volume micro forming

### INTRODUCTION

Micro manufacturing is a specialized field within manufacturing engineering that focuses on producing extremely small and precise components, products, and devices. It involves the fabrication of microscale features and structures, often with dimensions ranging from micrometers to a few millimeters. These products can generally be divided into the following categories: microelectronic products (Fig. 1a), micro optical products (Fig. 1b) and micro mechanical products (Fig. 1c) [1].



**Fig. 1.** Micro a) electronic, b) optical and c) mechanical products [1]

Microelectronic products are divided into active electronic elements, including transistors and integrated circuits, and into passive ones, which include resistors, capacitors, coils and the like. By merging them into functional circuits, electronic circuits such as stabilizers, rectifiers, oscillators, etc. are obtained. The production of optical elements and devices for transmission and processing of data using light-beam signals is done by micro optics. Micro mechanics is the production of various micro plants and parts such as motors, pumps, turbines, gears, bearings, etc. [1]. Micro manufacturing finds applications in various industries, such as electronics (microchips, sensors), medical (implantable devices, lab-on-a-chip), optics (micro lenses, micro mirrors), and telecommunications (micro-electromechanical systems or MEMS). Despite its potential, micro manufacturing faces challenges related to scalability, cost-effectiveness, and the need for specialized equipment and skilled personnel.

The percentage of sales of micro items is growing year by year, which is due to their increasing utilization in the worldwide market. Figure 2 depicts statistics on the rise of microproduct sales from 2014 to 2020 [2].



The authors [3] define micro manufacturing as:

- micro precision production of macro components,
- micro and nano geometric character production over large and small surfaces,
- micro-dimensional component production,
- production using micro and nano-scale materials,
- manufacturing with a controlled material structure.

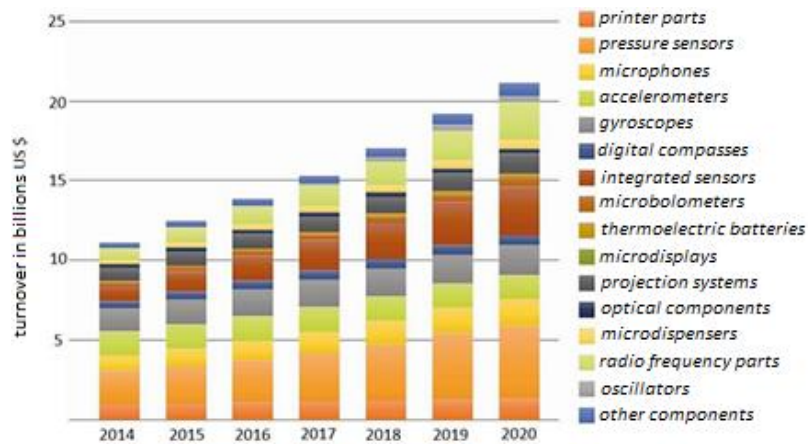


Fig. 2. Assessment the size and structure of sales turnover for the period 2014-2020. [2]

Key aspects of micro manufacturing include:

- **Miniaturization:** Micro manufacturing enables the creation of compact and lightweight products with intricate features. It's essential for industries like electronics, medical devices, aerospace, and automotive, where space and weight constraints are critical.
- **High Precision:** Achieving precise dimensions and tolerances at the microscale is a fundamental challenge. Micro manufacturing processes require advanced equipment and techniques to ensure accuracy and repeatability.
- **Diverse Techniques:** Micro manufacturing encompasses a wide range of techniques, including microfabrication, micro injection molding, micro manufacturing, microforming, and micro 3D printing, among others. These methods are tailored to suit specific materials and applications.
- **Multidisciplinary Approach:** Successful micro manufacturing often requires expertise in various fields, including materials science, mechanical engineering, electrical engineering, and microfluidics. Interdisciplinary collaboration is common.

This paper provides an overview of the recent advancements in the field of microforming. It is an advanced manufacturing process based on metal forming technology that involves the deformation of materials, typically metals, at a microscale level. Microforming has gained prominence due to its applications in various industries and its potential to address the growing demand for miniaturized and precise parts.

There are differences between conventional forming and microforming. This is a consequence of part miniaturization, a phenomenon commonly referred to as the "size effect." The following are some key distinctions between these two processes:

#### *Deformation Mechanism:*

In conventional forming, the deformation of the material occurs through bulk processes, often involving a large volume of material. Microforming achieves deformations by manipulating a relatively small number of crystal grains within the material, which is why the material cannot be considered homogeneous.

*Tooling and Equipment:*

Conventional forming typically utilizes larger and more robust equipment and tooling to accommodate the larger workpieces. Microforming requires specialized, high-precision tooling and equipment to work with the tiny dimensions involved.

*Tolerances and Surface Finish:*

Conventional forming may have more generous tolerances and surface finish requirements compared to microforming. Microforming demands extremely tight tolerances and precise control over surface finishes due to the miniature size of the components.

*Production Volume:*

Conventional forming is often associated with high-volume production runs of larger components. Microforming is suited for both low and high-volume production, making it versatile for various applications.

*Material Selection:*

Conventional forming can work with a wide range of materials, including metals, plastics, and composites. Microforming often focuses on metals and specific materials tailored for microscale applications.

*Energy Consumption and Environmental Impact:*

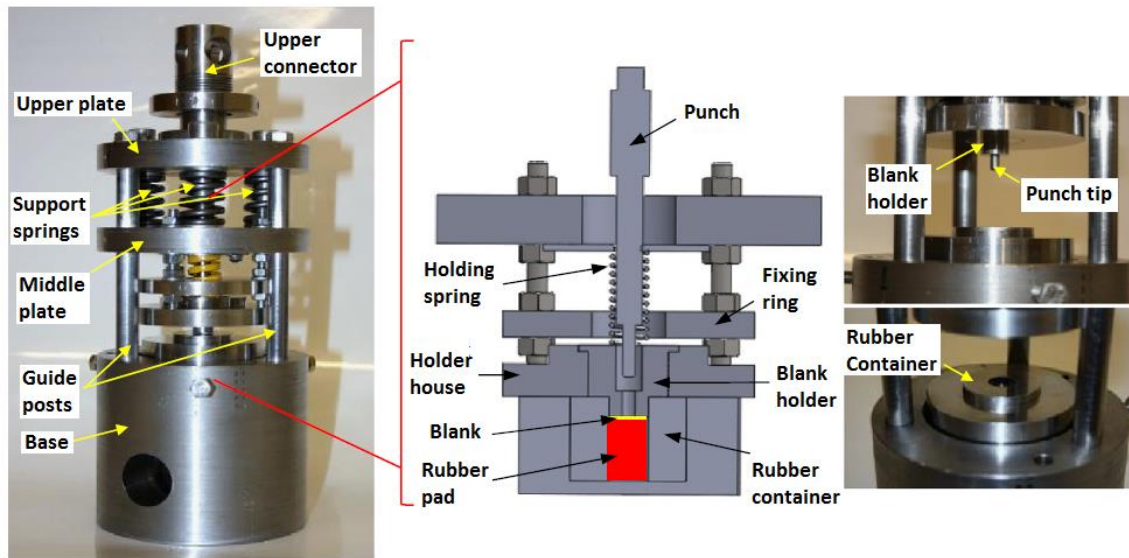
Due to the larger equipment and material volumes involved, conventional forming processes may consume more energy and have a larger environmental footprint. Microforming processes are typically more energy-efficient and environmentally friendly due to the smaller material volumes and reduced energy requirements.

In the following sections, the outcomes of various studies in the fields of sheet micro-processing and volumetric micro-deformation are presented. In the case of sheet metal processing, studies on micro deep drawing, micro hydroforming, and micro incremental forming of sheet metal have been examined. The emphasis of the bulk micro forming method is on micro extrusion. The impact of the "size effect" on mechanical properties of material was investigated using articles dealing with micro tensile and micro bending methods.

## **RECENT RESEARCHES IN THE FIELD OF MICROFORMING**

Micro deep drawing, as one of the micro manufacturing procedures, is used to produce very complex micro-sized parts. In order to examine the influence of the thickness of the part on the properties of deep drawing of copper, the experimental tests shown in the paper [4] were carried out. It has been shown by experimental research and a mathematical model that the size effect occurs when the grain size is kept constant while the dimensions of the sample or workpiece decrease. The paper proposed a model that, based on dislocation density, accounts for the influence of sample dimensions on its mechanical response. The effect of size on micro forming was also dealt with by the authors of the paper [5]. Flexible molding technology provides significant application potential in various areas of production, especially at the miniaturized level. The paper [6] presents the results of finite element simulation and experimental investigations of the micro deep drawing process of 304 stainless steel using a flexible matrix. The experimental apparatus is shown in the figure 3. The results showed that the anisotropic behavior of the steel 304 material plays an important role in the quality of the parts obtained, while the coefficient of friction between the material and the flexible matrix does not play an important role. Similar topics have been discussed by the authors of the paper [7]. The experiment and numerical analysis were also done in the paper [8], in order to determine the deformation behavior of the double layer Al-Cu composite at the micro scale. It has been shown that it is possible to use this composite for micro-processing. For the production of micro components with three-dimensional shapes, metal foils are very convenient and favorable. The authors of the paper [9] carried out micro tensile and micro

deep drawing tests on phosphor bronze foils of varying thickness. Research has been carried out in order to characterize existing rolled metal foils at production sites and to clarify the impact of its strong anisotropic properties on the formability of micro sheets. Based on the results obtained, it can be concluded that in addition to anisotropy of the material based on grain texture, it is necessary to take into account geometric anisotropy such as surface topography and damage. The topic of the application of metal foils was also addressed by the authors of the paper [10].



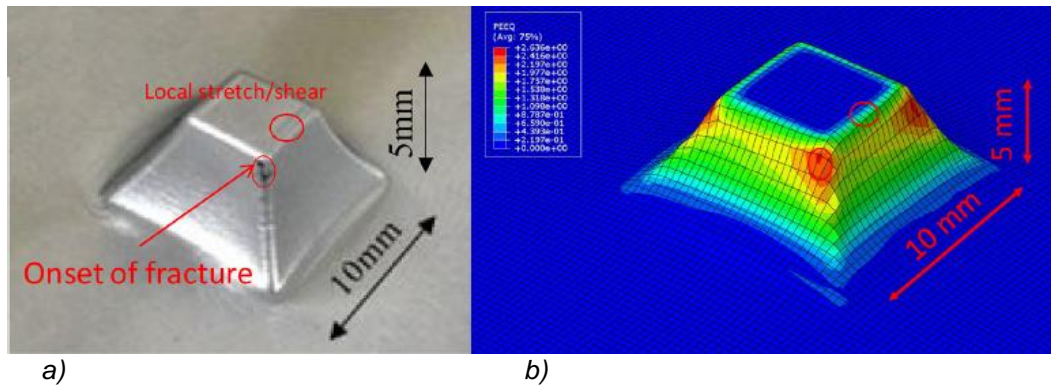
**Fig. 3.** The experimental apparatus [6]

The paper [11] used the piezoelectric actuator as a new approach in this area. As an experiment an analysis of the deep drawing of rectangular parts for 4 different scales is shown. The results shown showed that the thickness of the extracted part decreases, while the force increases, with increasing pressure, which is less pronounced with smaller scales. The spring back increases with the pressure of the holder.

A new approach was also done in the paper [12], where air under high pressure was used as a forming medium. This procedure is called micro pneumatic deep drawing. In order to achieve a high quality of parts, it is necessary to choose the optimal pressure value. In the paper [13] experimental studies of micro hydromechanical deep drawing were done to verify the processing ability of ultra-fine grained stainless steel. Two types of materials were used in this test, ultrafine grained stainless steel and SUS304-H with two types of 20 and 50  $\mu\text{m}$  thick. Experiments have shown that ultrafine grained stainless steel microparts for foil thicknesses of 20 and 50  $\mu\text{m}$  have been successfully obtained, in contrast to SUS304-H material microparts which have only been obtained for thicknesses of 50  $\mu\text{m}$ . The issue of micro hydro forming has also been addressed by the authors of papers [14] and [15]. The study [14] also carried out a test on the SUS304 plate to study the effect of hydraulic pressure on the quality of the drawn Cup. It has been shown that the application of hydraulic pressure can limit the formation of folds and rims, and if ultra-high pressure is used, they can be avoided. The work [15] is based on the processing of copper sheets by the micro / meso scale hydro forming process. Copper sheets of different thicknesses and grain sizes were used. As grain size approached sheet thickness, the maximum deformation height and maximum pressure decreased. Based on failure prediction by applying a modified GTN-Thomason model the parameters were optimized and successful fabrication of PEMFC single polar plate was achieved.

Incremental sheet metal forming is used in the industrial production of parts with simple universal manufacturing tools. The paper [16] minimized this process and studied the new material due to the limitations of the raw material. As a material, copper alloy tape was used. The results showed that the micro incremental sheet forming process is very effective when it

comes to identifying material parameters of the law of evolution of Lemaitre's ductile damage. This was observed by comparing the results of process simulations with experiments. The authors of the paper [17] studied the mechanism of deformation in micro single point incremental forming processes. Numerical analysis was done, as well as experimental research (Figure 4), and soft foil made of aluminum 1145 with a thickness of 38.1  $\mu\text{m}$  and 50.8  $\mu\text{m}$  was used as the material.



**Fig. 4.** Results of the a) experiment and b) numerical analysis [17]

It has been shown that the geometric accuracy of this process varies by region. At the very beginning of the procedure, the dominant area is bending / tightening where the accuracy is affected by the angle at which the test is carried out. Numerical simulation predicted the thickness distribution, which is close to what was obtained by the experiment. Each distribution clearly shows three regions with different deformation mechanisms: bending / tensile, shear, and tensile/ shear, with the last region being characteristic only of the micro scale. A similar problem was addressed by the authors of the paper [18], where the process of micro single point incremental forming of metal foil into a complex three-dimensional shape was examined. The experiment was performed using a tool with a hemispherical tip shape, moving along a predefined tool path. As a material, 50  $\mu\text{m}$  thick foils of Al 1100-O and Al 5052-H19 were used. The forming ability of the foil material Al 5052-H19 has been quantified with regard to determining the maximum wall angle that can be successfully formed by this procedure. The maximum wall angle of 41.8° achieved with the funnel experiment is less than that achievable for parts of the macro scale. In experiments with pyramid-shaped parts, an unusual form of rotation was discovered, which occurs due to an increase in step size and bending of the tool against the direction of movement of the tool. This can be eliminated by making stiffer molding tools or improving the tool movement itself. The work has proven that the developed settings give reliable and repeatable results, which once again confirmed the possibility of using this micro forming process. In order to determine the mechanical characteristics of micro parts, mechanical micro tests of these parts were carried out. Works [5], [19], [20], [21] and [22] show the results obtained by micro tensile, while the authors of the papers [23], [24], [25] and [26] analyzed the micro bending. Micro extrusion, as one of the areas of volume micro forming, has been analyzed in papers [27], [28] and [29]. As in all micro forming processes, so in this one, the size effect affects the processing process itself. The aim of the paper [27] was to precisely examine the effect of size and the effect of friction on material pressure and flow, as well as to further identify the actual flow pressure in micro-extrusion by filtering the friction effect. The experiment was performed on five samples with different diameters. Based on the results obtained, it can be concluded that the effect of friction on the voltage is very small in the initial phase of deformation. When increasing stress there is an increase in the contact area between the tool and the samples, leading to an increase in and a friction effect. The increase in the friction effect adversely affects the flow of the material, that is, there is a decrease in it. Also, it has been shown that sample size affects the stress in the material flow, i.e. by reducing sample size the stress values also decrease. For the purpose of similar analysis of this process, the paper [28] developed a generalpurpose tool for forward extrusion, backward

extrusion, forward rod - backward can extrusion and double cup extrusion. Local deformation occurs when only a few grains enter the micro-sized cavity, which occurs when grains are larger. Also, in the case of bulkier grains, a large number of slips occur that pass through the grain boundary to achieve stress continuity. This leads to a blurred grain boundary. In double cup extrusion process, there may be a decrease in the size of micro parts leading to an increase in interfacial friction between the tool and the workpiece. It can be concluded that there is an interactive effect of interfacial friction, plastic properties of micro parts, grain size and part size on deformation loading and geometry of micro-shaped parts. The friction at the phase boundary is higher in the micro extrusion process compared to the classical extrusion process. In the paper [29] an analysis was made of the influence of grain size and workpiece dimensions on the material in the open-type micro extrusion process. The work itself deals with both the process of micro extrusion as well as the process of micro forging. It is observed that extrusion processes, i.e. forging with open molds are not sensitive to the effect of grain size. The reason for this is the conclusion obtained, which is that the location of the neutral plane and its development through parts play a key role. It is the neutral plane, which demarcates the two directions of material flow in these two processes that determines the amount of material flow towards the aperture of the matrix, regardless of grain size. The results of the research also showed that grain size only affects the evolution of the microstructure during the process. In parts with coarse-grained microstructure, there is a delay in the development of the DMZ (Dead metal zone), due to the larger size of dislocation cells in the microstructure. This means that DMZ can be removed on the surface by increasing the initial grain size.

## CONCLUSION

The aim of this paper was to present recent advances in the field of microforming. The study of microforming has revealed its critical importance in modern manufacturing and its potential to revolutionize various industries. The fundamentals of the microforming process were explained, along with its similarities and differences compared to conventional deformation methods. Through the referenced studies, the size effect, material non-homogeneity, material elastic recovery, and other characteristics specific to these microforming processes were analyzed.

## FUNDING

This paper presents a portion of the research results from the project „Advanced Processing Technologies of Modern Engineering Materials“, No. 142-451-334/2023-01/2, which is being carried out as part of the 'Financing of Joint Research Projects of Scientific Research Organizations' initiative, jointly funded by the Autonomous Province of Vojvodina and scientific research organizations from the Republic of Srpska in 2023."

## REFERENCES

- [1] Piljek, P.: Model plitkog gravurnog kovanja temelje nna veličini kristalnog zrna, doktorski rad, Sveučilište u Zagrebu, Fakultet strojarstva i brodogradnje, Zagreb, 2017.
- [2] Milutinović, M., Kraišnik, M.: Nekonvencionalni postupci obrade plastičnim deformisanjem, Univerzitet u Novom Sadu, Fakultet tehničkih nauka, Novi Sad, 2019.
- [3] Fu, M. W., Chan, W. L.: Micro-scaled Products Development via Microforming. Springer, 2014.
- [4] Molotnikov, A., Lapovok, R., Gu, C. F., Davies, C. H. J., Estrin, Y.: Size effects in micro cup drawing. *Materials Science and Engineering: A*, 550, 312–319, 2012.
- [5] Luo, L., Jiang, Z., Wei, D., Manabe, K.-I., Sato, H., He, X., Li, P.: An experimental and numerical study of micro deep drawing of SUS304 circular cups, *Manufacturing Review*, 2, 27, 2015.



- [6] Irthiea, I., Greena, G., Hashima, S., Kriam, A.: Experimental and numerical investigation on micro deep drawing process of stainless steel 304 foil using flexible tools, *International Journal of Machine Tools & Manufacture*: 76, 21–33, 2014.
- [7] Irthiea, I.: Experimental and numerical evaluation of micro flexible deep drawing technique using floating ring, *Journal of Manufacturing Processes* 38, 556-563, 2019.
- [8] Jiaa, F., Zhaoa, J., Luoa, L., Xiea, H., Jianga, Z.: Experimental and numerical study on micro deep drawing with aluminium-copper composite material, *International Conference on the Technology of Plasticity, ICTP 2017, 17-22, Cambridge, United Kingdom, Procedia Engineering* 207 1051–1056, 2017.
- [9] Shimizu, T., Ogawa, M., Yang, M., Manabe, K.: Plastic anisotropy of ultra-thin rolled phosphor bronze foils and its thickness strain evolution in micro-deep drawing, *Materials & Design (1980-2015)*, 56, 604–612, 2014.
- [10] Furushima, T., Nakayama, T., Sasaki, K.: A new theoretical model of material inhomogeneity for prediction of surface roughening in micro metal forming, *CIRP Annals*, 68, 1, 257-260, 2019.
- [11] Aminzahed, I., Mashhadi, M. M., Sereshk. M. R. Z. V.: Investigation of holder pressure and size effects in micro deep drawing of rectangular work pieces driven by piezoelectric actuator, *Materials Science and Engineering: C*, 71, 685-689, 2017.
- [12] Zhang, Z., Chen, N., Furushima, T., Li, B.: Deformation behavior of metal foil in micro pneumatic deep drawing process, *17th International Conference on Metal Forming, Metal Forming 2018, 16-19, Toyohashi, Japan, Procedia Manufacturing* 15, 1422–1428, 2018.
- [13] Sato, H., Manabe, K., Kondo, D., Wei, D., Jiang, Z.: Formability of micro sheet hydroforming of ultra-fine grained stainless steel, *11th International Conference on Technology of Plasticity, ICTP 2014, 19-24, Nagoya Congress Center, Nagoya, Japan, Procedia Engineering* 81, 1463 – 146, 2014.
- [14] Luo, L., Wei, D., Wang, X., Zhou, C., Huang, Q., Xu, J., ... Jiang, Z.: Effects of hydraulic pressure on wrinkling and earing in micro hydro deep drawing of SUS304 circular cups, *The International Journal of Advanced Manufacturing Technology*, 90(1-4), 189–197, 2016.
- [15] Xu, Z., Peng, L., Yi, P., Lai, X.: An investigation on the formability of sheet metals in the micro/meso scale hydroforming process, *International Journal of Mechanical Sciences* 150, 265-276, 2019.
- [16] Hapsari, G., Hmida, R. B., Richard, F., Thibaud, S., Malécot. P.: A Procedure for Ductile Damage Parameters Identification by Micro Incremental Sheet Forming, *17th International Conference on Sheet Metal, SHEMET17, Procedia Engineering* 183, 125 – 130, 2017.
- [17] Song, X., Zhang, J., Zhai, W., Taureza, M., Castagne, S., Danno, A.: Numerical and experimental investigation on the deformation mechanism of micro single point incremental forming process, *Journal of Manufacturing Processes*, 36, 248–254, 2018.
- [18] Bansal, A., Jiang, B., & Ni, J.: Die-less fabrication of miniaturized parts through single point incremental micro-forming, *Journal of Manufacturing Processes*, 43, B, 20-25, 2019.
- [19] Hashigata, K., Chang, T.-F. M., Tang, H., Chen, C.-Y., Yamane, D., Konishi, T., Ito, H., Machida, K., Masu, K., Sone, M.: Strengthening of micro-cantilever by Au/Ti bilayered structure evaluated by micro-bending test toward MEMS devices, *Microelectronic Engineering*, 213, 13-17, 2019.
- [20] Yanagida, S., Chang, T.-F. M., Chen, C.-Y., Nagoshi, T., Yamane, D., Machida, K., ... Sone, M.: Tensile tests of micro-specimens composed of electroplated gold, *Microelectronic Engineering*, 174, 6–10, 2017.
- [21] Ando, M., Tanigawa, H., Kurotaki, H., & Katoh, Y.: Mechanical properties of neutron irradiated F82H using micro-tensile testing, *Nuclear Materials and Energy*, 16, 258–262, 2018.

- [22] Miura, T., Fujii, K., Fukuya, K., Ando, M., Tanigawa, H.: Micro-tensile testing of reduced-activation ferritic steel F82H irradiated with Fe and He ions, *Nuclear Materials and Energy*, 17, 24–28, 2018.
- [23] Fang, Z., Lu, H., Wei, D., Jiang, Z., Zhao, X., Zhang, X., Wu, D.: Numerical study on springback with size effect in micro V-bending, 11th International Conference on Technology of Plasticity, ICTP 2014, 19-24, Nagoya Congress Center, Nagoya, Japan, *Procedia Engineering* 81, 1011 – 1016, 2014.
- [24] Zheng, Q., Aoyama, T., Shimizu, T., Yang, M.: Experimental and numerical analysis of springback behavior under elevated temperatures in micro bending assisted by resistance heating, 11th International Conference on Technology of Plasticity, ICTP 2014, 19-24, Nagoya Congress Center, Nagoya, Japan, *Procedia Engineering* 81, 1481 – 1486, 2014.
- [25] Fang, Z., Jiang, Z., Wei, D., Liu, X.: Study on springback in micro V-bending with consideration of grain heterogeneity, *The International Journal of Advanced Manufacturing Technology*, 78(5-8), 1075–1085, 2014.
- [26] Asano, K., Tang, H.-C., Chen, C.-Y., Nagoshi, T., Chang, T.-F. M., Yamane, D., ... Sone, M.: Micro-bending testing of electrodeposited gold for applications as movable components in MEMS devices, *Microelectronic Engineering*, 180, 15–19, 2017.
- [27] LIN, J., LI, F., ZHANG, J.: A new approach to investigate real flow stress in micro-extrusion. *Transactions of Nonferrous Metals Society of China*, 22, s232–s238, 2012.
- [28] Chan, W. L., Fu, M. W., Yang, B.: Study of size effect in micro-extrusion process of pure copper, *Materials & Design*, 32(7), 3772–3782, 2011.
- [29] Ghassemali, E., Tan, M. J., Wah, C. B., Jarfors, A. E. W., Lim, S. C. V.: Grain size and workpiece dimension effects on material in an open-die micro-forging/extrusion process, *Materials Science & Engineering A*, 582, 379-388, 2013.





## ROBOTIC PROCESS AUTOMATION AND TEST AUTOMATION: EFFECTS ON BUSINESS PROCESSES AND SOFTWARE DEVELOPMENT PROCESSES

Sabri Yalçın<sup>1</sup>

<sup>1</sup>Carrefoursa Plaza, Cevizli Mahallesi Tugay Yolu Caddesi, No:67, Blok:B, 34846,  
Maltepe, İstanbul, Türkiye, T +90 2166550000, M +90 530 263 33 89

e-mail: [syalcin@carrefoursa.com](mailto:syalcin@carrefoursa.com)

**Abstract:** Today, the need to carry out business processes more effectively, faster, and error-free has made automation technologies important tools. Especially RPA (Robotic Process Automation) and Test Automation are used to automate business processes and improve software quality. The primary purpose of this article is to clearly define the differences and similarities between Robotic Process Automation (RPA) and Test Automation, to understand the effects of these two automation approaches on business processes and software development processes, and to determine in which situations they are most suitable for organizations. While RPA aims to automate business processes, Test Automation aims to test the software's accuracy. RPA and Test Automation can be used in R&D studies as important automation tools that can potentially optimize business processes. RPA and Test Automation are essential tools to improve organizations' workflows and increase the quality of software products. While RPA offers an effective solution to make business processes more efficient, Test Automation plays a vital role in improving software quality, especially by using it in software development processes.

**Keywords:** RPA, Test Automation, Business Process, Software, R&D.

### INTRODUCTION

In today's business world, the constantly changing and developing technological environment has increased the need to carry out business processes more efficiently, quickly and error-free [1]. In line with these needs, automation technologies are important tools for organizations to optimize their business processes and use resources more effectively [2]. Study presents two different automation approaches, especially "Robotic Process Automation" and "Test Automation". These approaches are used to automate business processes and improve the quality of software products [3-6].

RPA emerged as a technology developed to automate repetitive and manual business processes [7]. RPA, which takes on people's time-consuming and monotonous tasks, aims to minimize errors while increasing workforce efficiency [4]. On the other hand, Test Automation plays an important role in software development processes. It automates test scenarios to evaluate the software's functionality, performance, and reliability. In this way, it is possible to test the software quickly, detect errors, and increase the quality of the product [6,8].

Robotic Process Automation (RPA) is a technology that automates repetitive and manual components of business processes and tasks. The main features of RPA are [7,9,10]:

- RPA is a technology that automates business processes like a personal computer user can perform a task through software robots or bots. RPA covers repetitive tasks such as data entry, document processing, and extraction.
- RPA Application Areas: The use of RPA is found in a wide range. It optimizes business processes in many industries, such as finance, healthcare, logistics, customer service, and human resources.
- RPA offers some advantages, such as accelerating business processes, reducing errors, reducing operational costs, and allowing employees to focus on more strategic tasks.
- RPA is considered part of Industry 4.0 and can be used to make production processes more intelligent and automated.

Test automation is an approach used to evaluate software products' functionality, performance, and reliability. Important information in the literature on test automation is as follows [6,8,11,12]:

- **Definition of Test Automation:** Test automation runs test scenarios or test cases automatically instead of manually. Test automation allows the software to be tested quickly and potential bugs detected early.
- **Test Automation Tools:** There are many test automation tools and frameworks available. Tools like Robotium, Appium, JUnit, and MonkeyTalk are famous examples of software test automation.
- **Benefits of Test Automation:** Test automation can speed up software development processes, reduce costs, and improve software quality. Additionally, automating repetitive testing reduces human errors.
- **Test Automation and Continuous Integration (CI/CD):** Test automation contributes to the rapid deployment of software by using it as a part of continuous integration and continuous delivery processes (CI/CD).

## **MATERIAL AND METHODS**

In order to better understand the differences and similarities between RPA and Test Automation, the literature review method is used. By scanning the relevant literature, information was collected about these two automation approaches' features, advantages, disadvantages, and application areas. The two approaches' purposes, areas of use, advantages and disadvantages are examined in detail.

## **RESULTS AND DISCUSSION**

This section presents the findings obtained as a result of examining the differences and similarities between RPA and Test Automation within the scope of companies' R&D studies. Findings are presented based on literature review and analysis results.

### **Review of RPA and Test Automation Concepts**

As a result of the literature review, it was seen that the basic features of RPA and Test Automation concepts were determined. RPA has been defined as a technology that aims to automate repetitive and manual business processes. RPA allows automated data transfer, document processing, and decision processes. Test Automation is an approach used to verify the accuracy and functionality of software products. The software is tested under different conditions, and potential errors are detected thanks to automation scenarios.

### **Comparison of RPA and Test Automation Concepts**

The differences and similarities between RPA and Test Automation have been analyzed in detail. The main differences are:

- **Purpose:** While RPA aims to automate business processes, Test Automation aims to test the accuracy and functionality of the software.
- **Processes:** While RPA is generally used to automate a specific business process, Test Automation automates different scenarios of the software.
- **Flexibility:** RPA covers a broader range of processes, while Test Automation generally focuses on software testing.

The similarities are:

- **Automation Principles:** Both approaches aim to automate manual processes and make business processes efficient.
- **Middleware:** RPA and Test Automation are accomplished using proprietary software or tools.

- Data Integration: Both approaches can manage data transfer between systems or components.

### **Potential for Use in R&D Studies**

The potential for use of RPA and Test Automation in R&D studies was evaluated. RPA can enable R&D teams to focus on more strategic and creative projects by automating repetitive and time-consuming tasks. Test Automation, on the other hand, can speed up product development processes and improve the quality of the software. Both RPA and Test Automation can be integrated to provide more effective process management and efficiency in R&D efforts.

Examples of productivity increases that can be achieved by integrating both RPA (Robotic Process Automation) and Test Automation in R&D studies include:

- Fast and Reproducible Testing Processes: Test automation is faster than manual testing. Thanks to automation tools, the same test scenarios can be repeated quickly, thus reducing the time to find errors.
- Data Collection and Analysis with RPA: RPA can automate data collection and analysis processes. For example, processes such as pulling, cleaning, and analyzing large data sets can be accelerated with RPA.
- Integrated Data Stream: RPA can speed up data transfer between different sources. For example, RPA can extract and process data for an R&D project from different systems.
- Documentation and Reporting: Test automation can document test results regularly and generate reports. Test automation enables tracking the progress and results of R&D efforts more effectively.
- Decreased Error Susceptibility: Test automation minimizes human errors and makes processes more reliable. Test automation helps reduce errors that may occur in R&D work.
- More Strategic Use of Human Resources: Thanks to RPA and test automation, human resources can focus on more strategic tasks when repetitive and routine tasks are automated. RPA and test automation allows them to spend more time on the more creative and analytical aspects of R&D projects.
- Cost Savings: RPA and test automation are often less costly than manual processes. While human resources are saved, processes are carried out faster and without errors.
- Better Customer Satisfaction: Thanks to test automation, products can be made more reliable and error-free. Test automation increases customer satisfaction.
- Shortening the Project Timeline: Accelerating processes with test automation and RPA can shorten the timeline of R&D projects so results can be achieved faster.

These examples can be given as examples of the potential productivity increases that integrating RPA and Test Automation in R&D efforts can provide. Proper application of these technologies ensures that processes are carried out faster, reliably, and cost-effectively.

One of the critical differences between RPA and Test Automation is their purpose. RPA aims to automate repetitive and manual business processes and increase operational efficiency. It is particularly suitable for business processes such as data entry, document processing, and calculations. Test automation, conversely, aims to test the software's functionality, performance, and reliability and focuses on software development processes. Second, the way the processes are handled is different. While RPA emulates a specific business process, test automation automates different scenarios. This includes simulating scenarios such as user input, database queries, or error situations. Third, the areas in which they are used vary. While RPA can often automate business processes in many industries and business areas, test automation is more commonly used in software development processes and testing.

Regarding the critical similarities between RPA and Test Automation, they share automation principles and aim to increase efficiency and reduce errors by automating manual business

processes. Additionally, both are accomplished using specialized software or tools, making managing business processes or test cases easier.

Understanding the differences and similarities between RPA and test automation within the context of strategic considerations for organizations is critical to determining the right automation strategies. While RPA effectively improves operational efficiency and automates repetitive tasks, test automation is important for improving software quality and detecting bugs early. Organizations can integrate these two approaches depending on their needs and goals. In particular, these two automation approaches can be strategic tools for organizations that want to improve business processes and increase the quality of their software products.

By highlighting the differences and similarities between RPA and test automation, discussion aims to help organizations consciously use these two automation approaches. Therefore, organizations must consider these factors when creating automation strategies that suit their needs and goals.

## CONCLUSION

This study examined the differences and similarities between RPA and Test Automation and evaluated the effects of these two important automation approaches on business processes and software development processes. The findings reveal the following:

- RPA aims to automate repetitive and manual business processes and generally targets operational tasks. Test Automation aims to test the software's functionality, performance, and reliability and focuses on software development processes.
- Both approaches share automation principles, aiming to increase efficiency and reduce errors through automating manual business processes.
- Both RPA and Test Automation are performed using specialized software or tools, and these tools make managing business processes or test scenarios easier.
- RPA suits different industries and business areas, while Test Automation focuses more on software testing.
- Automating business processes and software testing offers organizations advantages such as efficiency, error reduction, and cost savings.

In conclusion, RPA and Test Automation are important tools for organizations to improve their processes and the quality of their software products. Understanding the differences and similarities of these two approaches can help organizations determine the right automation strategies. While RPA for business processes effectively increases operational efficiency, Test Automation for software development processes plays a critical role in improving software quality.

Organizations can integrate RPA (Robotic Process Automation) and Test Automation depending on their needs and goals. This can offer significant benefits in making business processes more effective and increasing productivity.

For example, an organization can integrate these two approaches by:

- Process Automation: With RPA, repetitive, manual, and routine tasks are automated.
- Test Automation: Software testing processes are automated to perform fast and repeatable tests. Software testing processes reduces debugging time and makes the software more reliable.
- Data Flow and Analysis: RPA can accelerate data flow between different data sources, while test automation can automate data analysis processes.
- Integration: Integrations can be created between RPA and Test Automation. For example, test results can be incorporated into RPA processes.
- Monitoring and Reporting: RPA and Test Automation tools can be used to monitor and report the performance of business processes.
- Customer Satisfaction and Quality Control: Test automation increases customer satisfaction by improving the quality of products. RPA, on the other hand, provides faster and error-free service to the customer.

- Project Management and Planning: Both RPA and Test Automation can speed up project management processes.

These integrations provide a versatile approach for organizations to make their business processes more efficient and achieve their goals faster. Organizations can achieve the best results by combining these technologies according to their needs.

## REFERENCES

- [1] Üzmez, S. S., & Büyükbeşe, T. (2021). Dijitalleşme sürecinde bilgi yönetiminin işletmelerin teknoloji uyumuna etkileri. *Bilgi Ekonomisi ve Yönetimi Dergisi*, 16(2), 117-127.
- [2] Yankın, F. B. (2019). Dijital dönüşüm sürecinde çalışma yaşamı. *Trakya Üniversitesi İktisadi ve İdari Bilimler Fakültesi E-Dergi*, 7(2), 1-38.
- [3] Berner, S., Weber, R., & Keller, R. K. (2005, May). Observations and lessons learned from automated testing. In *Proceedings of the 27th international conference on Software engineering* (pp. 571-579).
- [4] Dey, S., & Das, A. (2019). Robotic Process Automation: Assessment of the technology for transformation of business processes. *International Journal of Business Process Integration and Management*, 9(3), 220-230.
- [5] Gamido, H. V., & Gamido, M. V. (2019). Comparative review of the features of automated software testing tools. *International Journal of Electrical and Computer Engineering*, 9(5), 4473.
- [6] Karout, R., & Awasthi, A. (2017). Improving software quality using Six Sigma DMAIC-based approach: A case study. *Business Process Management Journal*, 23(4), 842-856.
- [7] Büyükarıkan, U. (2022). Muhasebe bilgi sisteminde Robotik Süreç Otomasyonu. *Aydın İktisat Fakültesi Dergisi*, 7(1), 25-32.
- [8] Yener, H. A., Baştürk, F., & Meçik, B. (2019). Yazılım geliştirme ve Test Otomasyon ile verimlilik artışı: General mobile. *Karamanoğlu Mehmetbey Üniversitesi Mühendislik ve Doğa Bilimleri Dergisi*, 1(1), 172-196.
- [9] Çivak, H. (2022). Robotik Süreç Otomasyonu: Bir Uygulama Örneği. Yüksek Lisans Tezi, Karabük Üniversitesi, Lisansüstü Eğitim Enstitüsü, Karabük.
- [10] Ribeiro, J., Lima, R., Eckhardt, T., & Paiva, S. (2021). Robotic Process Automation and artificial intelligence in industry 4.0—a literature review. *Procedia Computer Science*, 181, 51-58.
- [11] Hussain, A., Razak, H. A., & Mkpojiogu, E. O. (2017). The perceived usability of automated testing tools for mobile applications. *Journal of Engineering, Science and Technology (JESTEC)*, 12(4), 89-97.
- [12] Rangnau, T., Buijtenen, R. V., Franssen, F., & Turkmen, F. (2020, October). Continuous security testing: A case study on integrating dynamic security testing tools in ci/cd pipelines. In *2020 IEEE 24th International Enterprise Distributed Object Computing Conference (EDOC)* (pp. 145-154). IEEE.



## NUMERICAL ANALYSIS OF GAS-SOLID FLOW IN A REVERSE FLOW CYCLONE SEPARATOR

Muharrem Hilmi Aksoy<sup>1</sup>, Ali Öner<sup>2</sup>, Muhammed Osman Duman<sup>1</sup>, Mert Turan<sup>1</sup>,

<sup>1</sup> Konya Technical University, Faculty of Engineering and Natural Science,

Department of Mechanical Engineering, Konya, Türkiye

e-mails: [mhaksoy@ktun.edu.tr](mailto:mhaksoy@ktun.edu.tr); [osmanduman93@gmail.com](mailto:osmanduman93@gmail.com);

[mertturan1696@gmail.com](mailto:mertturan1696@gmail.com)

<sup>2</sup> İmaş Machinery Inc. R&D Center, Konya, Türkiye

e-mail: [alioner92@gmail.com](mailto:alioner92@gmail.com)

**Abstract:** Aerocyclone separators are crucial in separating solid particles from gas streams. These cyclones exhibit diverse geometrical configurations in their inlet zones, including tangential, spiral, helical, and axial designs, with variations within the tangential type. Beyond their economic appeal, these devices are characterized by their resilience to high temperatures and pressures, ease of manufacturing, and uncomplicated geometrical structures. Among the factors influencing cyclone performance, the critical parameters of interest encompass dust collection efficiency and pressure loss. The present study employed a Stairmand-type counter-flow cyclone to separate flour particles dispersed within an air medium. A numerical investigation considered cyclone heights of  $H = 750$  mm,  $H = 1000$  mm, and  $H = 1500$  mm. Furthermore, cyclone inlet velocities of 8 m/s, 13 m/s, and 17 m/s were specifically chosen for examination. Particle sizes ranged from 1 to 10 micrometers, ensuring the evaluation extended to conditions achieving 100% collection efficiency. A comprehensive analysis of pressure drop ratios was presented herein, offering insights into the impact of varying inlet speeds and cyclone dimensions.

**Key words:** cyclone, collection efficiency, pressure drop, flow analysis.

### INTRODUCTION

The separation of gases and the solid particles they carry is important in process industries, and it is achieved through various methods. Solid particles can intentionally be present in the gas flow, for example, in pneumatic conveying systems, where it may be necessary for 100% solid recovery at the end of the conveying process to have an economical process [1-2]. The applied centrifugal force forms a vortex inside the cyclone, and the gas swirls toward the conical bottom. Larger particles with a considerable diameter are then pushed towards the wall and separated from the gas. In the conical section, the gas flow reverses direction to move upward over the central part of the cyclone and exits from the top through the gas outlet pipe. Meanwhile, solid particles move downward along the wall and accumulate at the bottom of the conical section [3-4].

Cyclone separators are widely used in industries to separate and collect particles from gases or similar gas mixtures containing solid particles such as dust, chips, or grains. They are used in industrial dust collection systems to capture particles as small as 50 microns. Commercial cyclones can operate at flow rates ranging from 50 to 5000 m<sup>3</sup>/h. In cases where they do not provide the required efficiency, they can be used in conjunction with high-efficiency collection devices. Cyclone separators are categorized into two groups: axial inlet cyclones and tangential inlet cyclones [5-6]

Shepperd & Lapple, Avant, Parnell & Sorenson cyclone models are commonly used in the agricultural industry. Simpson & Parnell, to address the cotton processing sector's lint problem, used a low-pressure cyclone model. The Stairmand Cyclone was selected in this study due to its high dust collection efficiency [7].

Several parameters influence cyclone performance. These parameters include the type of cyclone, cyclone dimensional ratios, outlet pipe height (stack), cyclone inlet velocity, outlet

pipe diameter, temperature, and variations in particle concentration. Altering these parameters can affect cyclone performance criteria, such as pressure drop and efficiency [8]. The literature review comprehensively examines research endeavors focused on comprehending and optimizing cyclone separator performance. Scholars have rigorously investigated the impact of diverse factors such as geometry, flow rates, and particle concentration on cyclone efficiency and pressure drops. Pioneering work by Leith and Licht [9] introduced a theory for calculating particle collection efficiency in cyclone separators, incorporating the drag coefficient to enhance particle collection efficiency. Their efforts also yielded an efficiency model capable of accounting for pressure losses. Subsequent studies, like those by Griffiths and Boysan [10], employed numerical simulations to analyze particle capture efficiency and pressure drops in different cyclones, aligning their findings with existing literature. Barth's [11] model was found accurate for small cyclones, whereas Iozia and Leith's [12] model proved precise for larger counterparts. The integration of CFD analyses further enriched the field, providing reliable predictions for pressure drops and particle capture efficiency. Bohnet [13] delved into experimental studies, examining cyclone performance at high temperatures, revealing significant pressure drops and efficiency curves for specific temperature values. Linden and Gudmundsson [14] explored parameters affecting cyclone collection efficiency, highlighting the critical influence of the ratio of cyclone body diameter to vortex tube inner diameter and its independence from the Reynolds number.

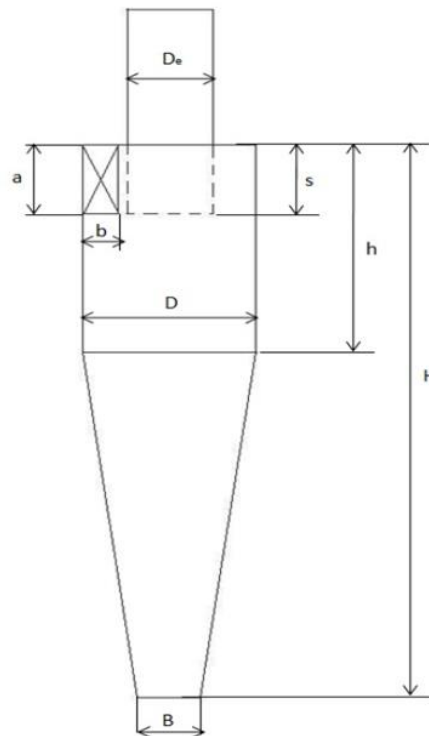
Avcı and Erel [15] introduced an approach to determine optimal cyclone length, finding no efficiency increase beyond a certain length, suggesting potential adjustments at high and low velocities. Avcı and Karagöz [16] explored the effects of flow and geometric parameters, unveiling the significant roles of surface friction, vortex length, and flow regime. Faulkner et al. [17] identified an inverse relationship between cyclone diameter and efficiency. Advanced computational techniques, as evidenced by Kaya and Karagöz [18], emphasized the accuracy of the Reynolds turbulence model in predicting cyclone behavior. Novel designs, like Tan F.'s [19] modified cyclone, showcased the potential for reimagining cyclone structures. Erol et al. [20] employed numerical and experimental methods, refining our understanding of exit pipe diameter influence. Recent studies, including those by Chu et al. [21], Pandey and Brar [22], and El-Emam et al. [23], harnessed advanced computational and experimental techniques, pushing the boundaries of cyclone optimization.

In this study, a Stairmand-type counter-flow cyclone was used to separate flour particles in an air medium. Numerical simulations were conducted with cyclone heights of 750 mm, 1000 mm, and 1500 mm, along with inlet velocities of 8 m/s, 13 m/s, and 17 m/s. Particle sizes ranged from 1 to 10 micrometers, allowing for a thorough evaluation of conditions and achieving 100% collection efficiency. The analysis included a detailed examination of pressure drop ratios, providing valuable insights into the effects of different speeds and cyclone dimensions.

## **MATERIAL AND METHODS**

In the study, the particle bulk density was assumed to be 550 kg/m<sup>3</sup>, and a flow rate of 1000 m<sup>3</sup>/h of air contained 18 kg of these particles. Two distinct groups of parameters are employed in the design of aerosol cyclones. This study focuses on parameters based on design, which vary according to the selected cyclone type. The selection and manipulation of these parameters play a pivotal role in the design and performance optimization of aerosol cyclones. Different cyclone types require adjustments in these parameters to achieve desired efficiency and particle separation outcomes. Figure 1 presents the design parameters specific to the Stairmand-type cyclone. These parameters are integral to the intricate process of cyclone design. In Stairmand-type cyclones, the parameters are dimensioned relative to the body diameter "D" [24].





**Fig. 1.** The design parameters of the Stairmand type cyclone

**Table 1.** The dimensions of the Stairmand cyclone

Parameter	Dimension*D
Cyclone diameter, D	1.0 D
Air outlet pipe diameter, $D_e$	0.5 D
Height of air inlet section, a	0.5 D
Width of air inlet section, b	0.2 D
Dip depth of the outlet pipe, s	0.5 D
Cyclone height, H	4.0 D
Body height, h	1.5 D
Dust outlet diameter, B	0.375 D

When multiplied by the body diameter "D", these standardized dimensions provide precise measurements for each component, ensuring consistency and accuracy in the design and evaluation of Stairmand-type cyclones.

In the computational fluid dynamics (CFD) analysis, parameters were meticulously chosen to simulate the complex dynamics within the cyclone separator. Particle density was fixed at 0.80 kg/m<sup>3</sup> for flour material. The simulation's choice of spherical particle shape was made to capture real-world scenarios accurately. The gas flowing into the system was at a stable temperature of 27 °C, with an outlet pressure maintained at 101625 Pa. Furthermore, the air density was chosen as air set at 1.1 kg/m<sup>3</sup>, while the viscosity was calculated at 1.7810<sup>-5</sup> kg/(ms). The ambient temperature was also held constant at 27 °C, reflecting standard environmental conditions. The inlet velocities, a critical variable influencing the cyclone's efficiency, were tested at three different values: 8 m/s, 13 m/s, and 17 m/s. This range allowed for a comprehensive analysis of the cyclone's performance under various flow rates, providing valuable insights into its operational flexibility. Moreover, the surface roughness of the cyclone material was specified at 0.39, a factor contributing significantly to the friction between particles and the cyclone walls as taken as a metal sheet. These chosen parameters served as the foundation for the computational analysis, enabling a detailed exploration of the cyclone separator's behavior under different operating conditions.

The K-Epsilon Model has been a foundational tool for simulating turbulent flows in CFD. A modification called the RNG Option was introduced to enhance accuracy in swirling flows.

Specifically tailored for swirl-dominated scenarios, this adjustment ensures precise simulations by employing standard wall functions for near-wall treatment. For the CFD analysis, specific boundary conditions are set:

Inlet and Wall: Particles rebound off these boundaries, with their momentum changing as determined by the coefficient of restitution. Outlet (Top): When particles encounter this boundary, their trajectories end, signifying that they have 'escaped.' Outlet (Bottom/Dustbin): Particle trajectories are terminated, and the outcome is recorded as 'trapped.' For evaporating droplets, their entire mass instantly transitions into the adjacent cell's vapor phase. In the case of a combusting particle, the remaining volatile mass enters the vapor phase.

In the realm of CFD analysis, the concept of separation efficiency in cyclone separators is crucial. It quantifies the fraction of particles of a specific size captured within the cyclone concerning those particles of the same size entering the cyclone. Empirical observations have demonstrated that the efficiency of cyclone separators rises with increasing particle mean diameter and density, heightened gas tangential velocity, diminished cyclone diameter, elongated cyclone length, and the removal of gas alongside solids through the cyclone legs. In this context, the Separation Efficiency is precisely defined based on particle history data. It represents the proportion of concentration removed from the incoming feed stream compared to the initial concentration. This efficiency measure is calculated by determining the ratio of trapped particles to the total number of particles tracked in the system, as given in Eq 1.

$$Efficiency = \frac{N. of particles trapped}{N. of particles tracked} \quad (1)$$

In practical engineering applications, derivatives of the k-ε model exhibit comparable structures, featuring transport equations for turbulent kinetic energy (k) and dissipation rate (ε). The Renormalization Group (RNG) k-ε model is grounded in the instantaneous Navier-Stokes equations. It sets the RNG k-ε model apart from the Standard k-ε model is analytical derivation, involving incorporating model constants and supplementary terms within the transport equations [25].

$$\frac{\partial}{\partial t}(\rho k) + \frac{\partial}{\partial x_i}(\rho k u_i) = \frac{\partial}{\partial x_i} \left[ \mu_{eff} \alpha_k \frac{\partial k}{\partial x_j} \right] + G_k - \rho \varepsilon + S_k \quad (2)$$

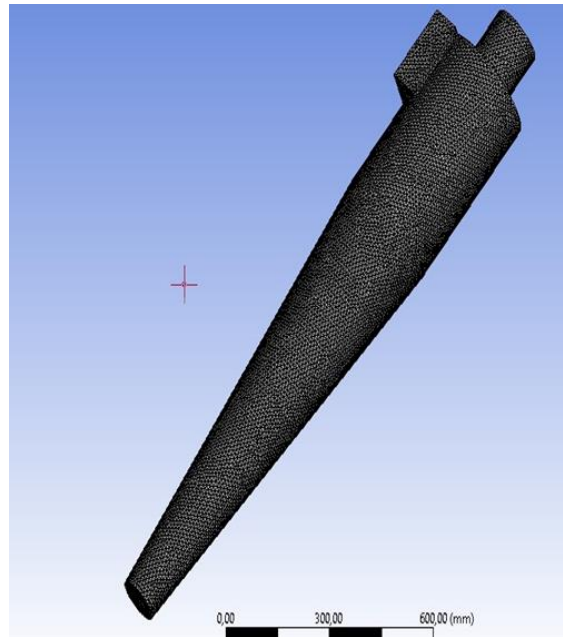
$$\frac{\partial}{\partial t}(\rho \varepsilon) + \frac{\partial}{\partial x_i}(\rho \varepsilon u_i) = \frac{\partial}{\partial x_i} \left[ \mu_{eff} \alpha_k \frac{\partial \varepsilon}{\partial x_j} \right] + C_{1\varepsilon} G_k \frac{\varepsilon}{k} - C_{2\varepsilon} \rho \frac{\varepsilon^2}{k} - R_\varepsilon + S_\varepsilon \quad (3)$$

The fundamental disparity between the RNG (Renormalization Group) and the standard k-ε turbulence models lies in the presence of an additional term within the dissipation rate (ε) equation, depicted as follows:

$$R_\varepsilon = \frac{C_\mu \rho \eta^3 (1 - \eta/\eta_0) \varepsilon^2}{1 + \beta \eta^3} \frac{1}{k} \quad (4)$$

In this equation, the constant  $C_\mu$  is set to 0.0845,  $\eta \equiv Sk/\varepsilon$ ,  $\eta_0$  equals 4.38, and  $\beta$  equals 0.012. Notably, the RNG model exhibits heightened sensitivity to strain and streamline curvature impacts when contrasted with the Standard k-ε model, where the constants  $C_{1\varepsilon}$  and  $C_{2\varepsilon}$  are 1.44 and 1.92, respectively.

A mesh independency study indicates that  $4 \times 10^5$ ,  $9,5 \times 10^5$ , and  $20 \times 10^5$  elements are deemed adequate for 750 mm, 1000 mm, and 1500 mm for the analyses, respectively. A mesh structure used in this study is given in Fig.2.



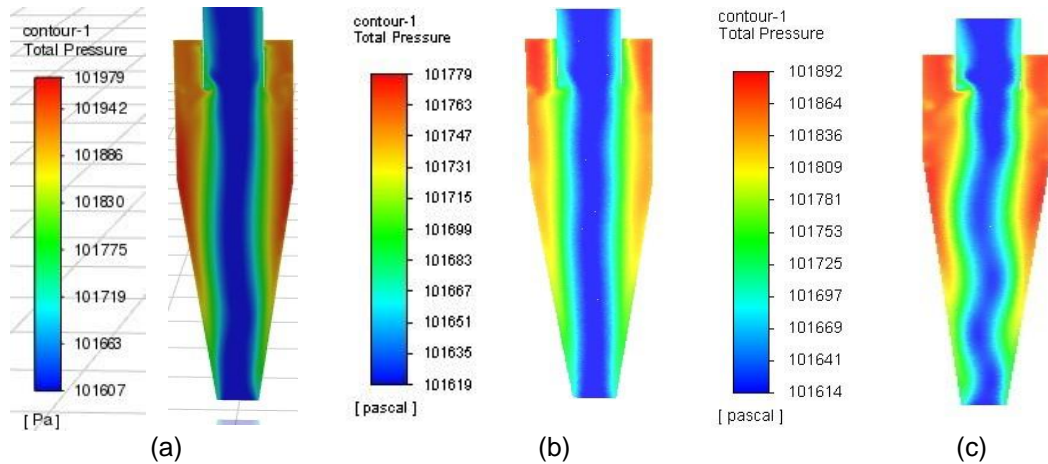
*Fig. 2. Mesh structure of the cyclone*

## RESULTS AND DISCUSSION

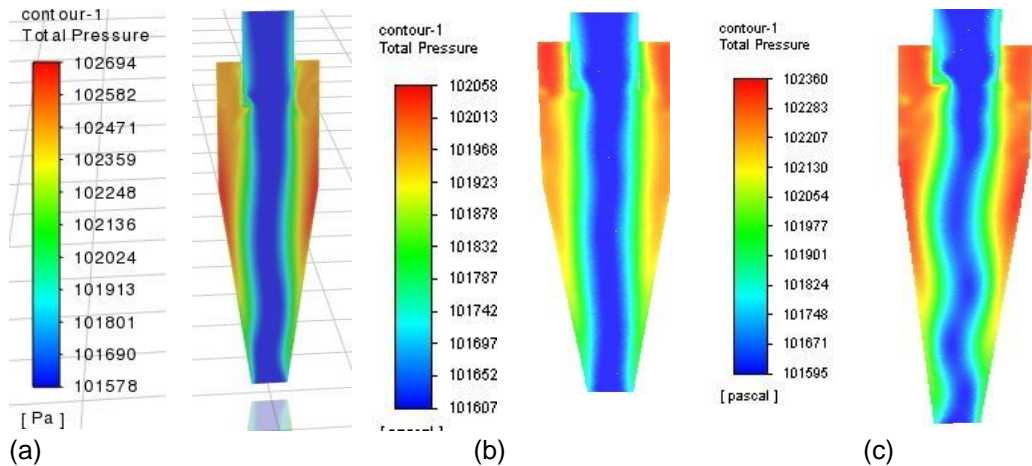
In the following section, we delve into the results and discussions derived from CFD analysis of cyclone separators. Through the computational simulations, we have explored various parameters that significantly influence cyclone performance, including geometry modifications and flow rates. Tangential and axial velocities are important factors for the particle collection in the cyclones. The total pressure contours in Figures 3, 4, and 5 are presented at inlet velocities of 8, 13, and 17 m/s, respectively. These figures illustrate pressure variations in three dimensions, corresponding to different H heights, denoted as options a, b, and c. Geometric measurements have been adjusted to represent diverse pressure changes in these three-dimensional contexts. Due to swirling velocity within the cyclone, a distinct negative pressure zone manifests in its central region. Remarkably, the pressure reaches its nadir close to the cyclone's center, contrasting sharply with the positive and maximal pressure values observed near the cyclone periphery. This signifies a radial decline in pressure, where the pressure diminishes from the wall towards the core. Notably, as the diameter of the vortex finder decreases, there is a discernible augmentation in pressure. This phenomenon underscores the significant correlation between pressure and velocity. Consequently, an escalation in tangential velocity is anticipated to correspond with an elevation in pressure. Furthermore, the study observes a substantial pressure gradient along the radial direction, emphasizing its pronounced nature in this dimension, while it remains comparatively restricted in the axial orientation. This intricate interplay between velocity, pressure, and geometry underscores the complex dynamics at play within cyclonic systems.

In cyclone design, paramount objectives are maximizing separation efficiency while minimizing pressure drop. A superior separation efficiency and a minimal pressure drop constitute the optimal outcome for cyclone designs. This intricate balance necessitates understanding various physical and geometrical variables that influence cyclone behavior. These variables encompass particle density, gas viscosity, cyclone dimensions, particle cut-off diameter, inlet velocity, and numerous other factors. The manipulation and comprehension of these variables are pivotal in crafting cyclone designs that align with the desired efficiency and pressure drop criteria, reflecting the intricate interplay of diverse parameters in cyclone performance optimization. The impact of inlet velocity on fractional separation efficiency is a critical aspect of cyclone separator performance analysis. Understanding how varying inlet velocities influence particle separation efficiency is essential

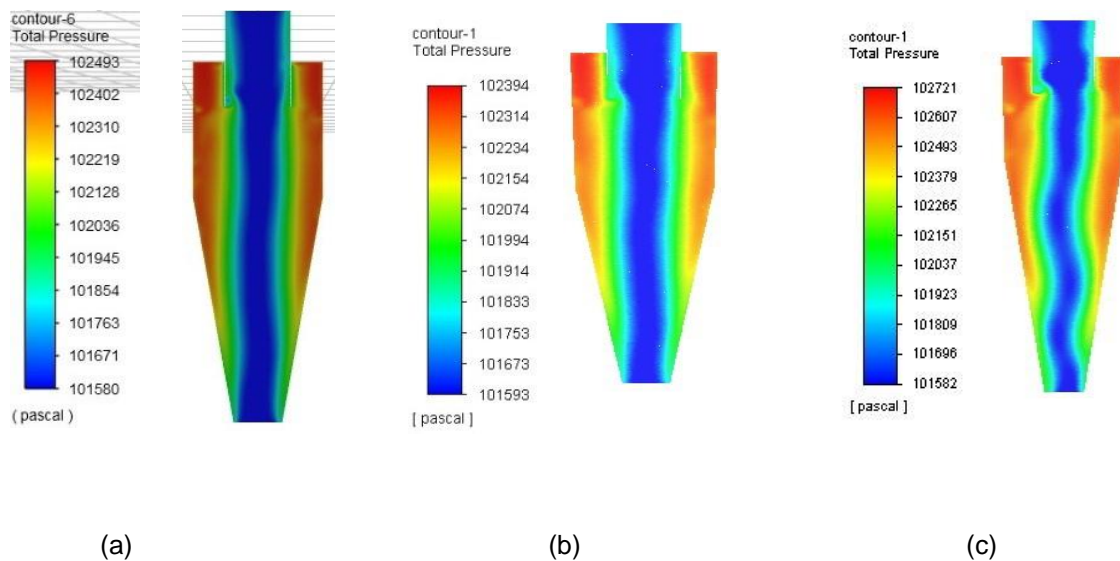
for optimizing cyclone designs. This parameter significantly affects the cyclone's ability to capture particles of different sizes and densities, directly influencing the separation process's overall efficiency.



**Fig.3.** Pressure Contours in Cyclones with (a)  $H = 750$  mm, (b)  $H = 1000$  mm, and (c)  $H = 1500$  mm at a Velocity of 8 m/s.

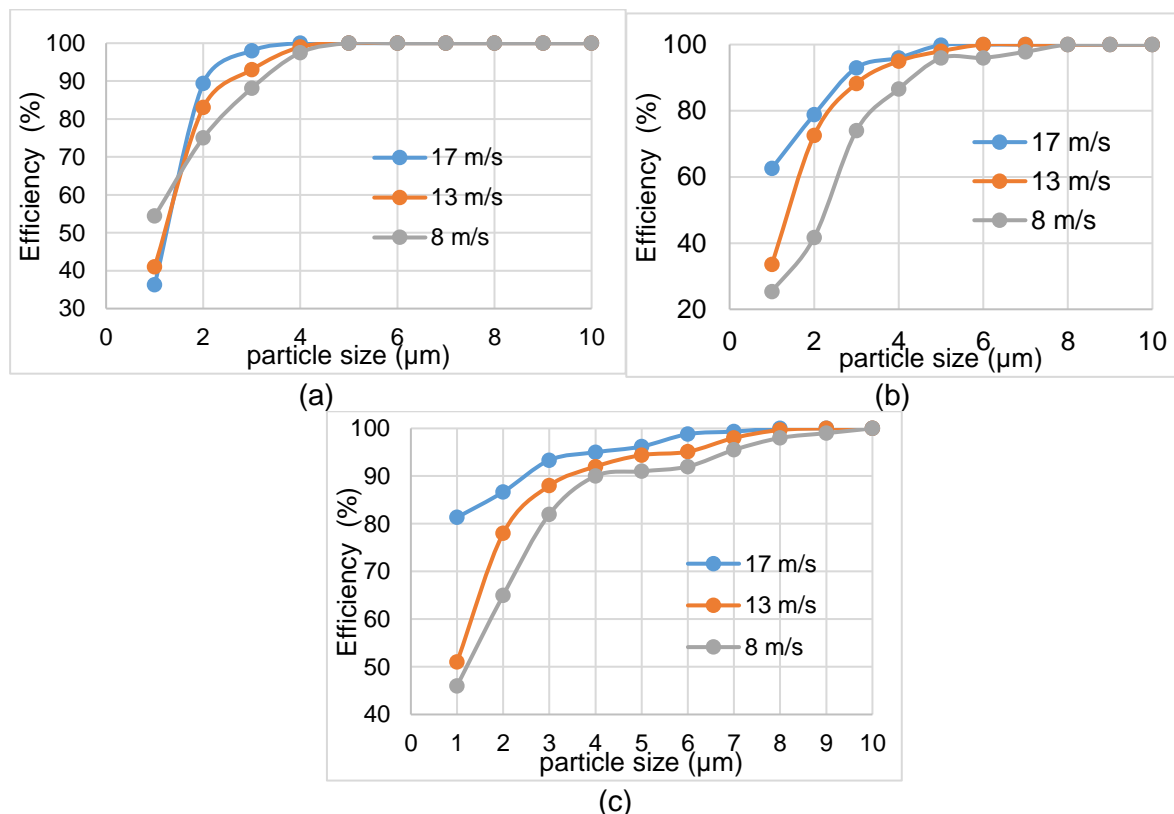


**Fig.4.** Pressure Contours in Cyclones with (a)  $H = 750$  mm, (b)  $H = 1000$  mm, and (c)  $H = 1500$  mm at a Velocity of 13 m/s.



**Fig.5.** Pressure Contours in Cyclones with (a)  $H = 750$  mm, (b)  $H = 1000$  mm, and (c)  $H = 1500$  mm at a Velocity of 17 m/s.

In the discrete phase model, particles are introduced at the cyclone's inlet and meticulously tracked to assess fractional separation efficiency, a crucial parameter in cyclone performance evaluation. The separation efficiency represents the ratio of captured particles to those injected, considering incomplete particles. Particles ranging from 1 to 10  $\mu\text{m}$  diameter were released at the inlet to simulate the cyclone's separation efficiency. Figure 6 illustrates the separation efficiency concerning particle diameter at three distinct inlet velocities for a cyclone with different diameters. The graph depicts a direct correlation between efficiency, particle size, and inlet velocity, indicating that higher efficiencies are achieved with larger particles and increased inlet velocities. This relationship is rooted in the proportional nature of centrifugal force to flow velocity, highlighting the direct influence of centrifugal force on collection efficiency. As it is seen, as the H height increases, 100% efficiency is achieved at higher particle size.



**Fig.6.** The effect of the inlet velocity on separation efficiency of cyclones (a)  $H = 750$  mm, (b)  $H = 1000$  mm, and (c)  $H = 1500$  mm

## CONCLUSION

In this comprehensive study, the intricate dynamics of cyclone separators were meticulously explored through CFD simulations. The focus was on a Stairmand-type counter-flow cyclone utilized for separating flour particles within an air medium. The research delved into an array of crucial parameters, including cyclone heights ( $H = 750$  mm,  $H = 1000$  mm, and  $H = 1500$  mm) and inlet velocities (8 m/s, 13 m/s, and 17 m/s). This systematic analysis provided deep insights into the cyclone's behavior under diverse operational conditions.

One of the key findings highlighted the significant influence of geometry and flow rates on cyclone performance. The analysis of pressure contours revealed intricate patterns within the cyclone structure. A notable negative pressure zone was observed in the central region due to swirling velocity, with pressure reaching its minimum at the cyclone's center. This was sharply contrasted by positive and maximal pressure values near the cyclone periphery, illustrating a radial decline in pressure from the wall toward the core. Moreover, the reduction

in the vortex finder diameter increased pressure, emphasizing the direct correlation between pressure and velocity.

In examining the impact of inlet velocity on fractional separation efficiency, a critical aspect of cyclone performance, the study revealed a direct relationship between efficiency, particle size, and inlet velocity. Larger particles and increased inlet velocities resulted in higher efficiencies, underlining the pivotal role of centrifugal force proportional to flow velocity in the collection process.

Future research directions could delve deeper into integrating advanced materials on surfaces, optimized geometries, and experimental techniques to enhance cyclone separator efficiency further and contribute to sustainable industrial practices in milling and other industries.

## REFERENCES

- [1] Jüttner, K., U. Galla, and H. Schmieder. "Electrochemical approaches to environmental problems in the process industry." *Electrochimica Acta* 45.15-16 (2000): 2575-2594.
- [2] Utikar, Ranjeet, et al. "Hydrodynamic simulation of cyclone separators." *Computational fluid dynamics. InTech*, 2010. 241-266.
- [3] Wang, B., Xu, D. L., Chu, K. W., & Yu, A. B. (2006). Numerical study of gas–solid flow in a cyclone separator. *Applied Mathematical Modelling*, 30(11), 1326-1342.
- [4] Liu, Z., Zheng, Y., Jia, L., Jiao, J., & Zhang, Q. (2006). Stereoscopic PIV studies on the swirling flow structure in a gas cyclone. *Chemical Engineering Science*, 61(13), 4252-4261.
- [5] Obernberger, I., Brunner, T., & Bärnthaler, G. (2006). Chemical properties of solid biofuels—significance and impact. *Biomass and bioenergy*, 30(11), 973-982.
- [6] Schummer, P., Noe, P., & Baker, M. (1992). LDV measurements in the vortex flow created by a rotating wall dewatering cyclone. In *Hydrocyclones: Analysis and Applications* (pp. 359-376). Dordrecht: Springer Netherlands.
- [7] Sharma, G., & Majdalani, J. (2022). Effects of various inlet parameters on the computed flow development in a bidirectional vortex chamber. *Physics of Fluids*, 34(4).
- [8] Bhasker, C. (2010). Flow simulation in industrial cyclone separator. *Advances in Engineering software*, 41(2), 220-228.
- [9] Leith, D., and Licht, W. (1972). *AIChE Sym. Ser.* 68 : 196
- [10] Griffiths, W. D., & Boysan, F. (1996). Computational fluid dynamics (CFD) and empirical modelling of the performance of a number of cyclone samplers. *Journal of Aerosol Science*, 27(2), 281-304.
- [11] Barth, W. (1956). Berechnung und auslegung von zyklonabscheidern auf grund neuer untersuchungen. *Brennst.-Warme-Kraft*, 8, 1-9.
- [12] Iozia, D. L., & Leith, D. (1989). Effect of cyclone dimensions on gas flow pattern and collection efficiency. *Aerosol Science and Technology*, 10(3), 491-500.
- [13] Bohnet, M., Gottschalk, O., & Morweiser, M. (1997). Modern design of aerocyclones. *Advanced Powder Technology*, 8(2), 137-161.
- [14] Lidén, G., & Gudmundsson, A. (1997). Semi-empirical modelling to generalise the dependence of cyclone collection efficiency on operating conditions and cyclone design. *Journal of aerosol science*, 28(5), 853-874.
- [15] Avci, A., & Erel, G. K. (2003). Siklon separatorlerde uzunluğun verime etkisi ve optimizasyonu. *Uludağ Üniversitesi Mühendislik-Mimarlık Fakültesi Dergisi*, 8(1), 101-109.
- [16] Karagoz, I., & Avci, A. (2005). Modelling of the pressure drop in tangential inlet cyclone separators. *Aerosol Science and Technology*, 39(9), 857-865.
- [17] Faulkner, W. B., Buser, M. D., Whitelock, D. P., & Shaw, B. W. (2008). Effects of cyclone diameter on performance of 1D3D cyclones: cutpoint and slope. *Transactions of the ASABE*, 51(1), 287-292.

- [18] Kaya, F., & Karagoz, I. J. C. E. (2008). Performance analysis of numerical schemes in highly swirling turbulent flows in cyclones. *Current science*, 1273-1278.
- [19] Tan, F., Karagoz, I., & Avci, A. (2016). Effects of geometrical parameters on the pressure drop for a modified cyclone separator. *Chemical Engineering & Technology*, 39(3), 576-581.
- [20] Erol, H. I., Turgut, O., & Unal, R. (2019). Experimental and numerical study of Stairmand cyclone separators: a comparison of the results of small-scale and large-scale cyclones. *Heat and Mass Transfer*, 55, 2341-2354.
- [21] Chu, K., Chen, Y., Ji, L., Zhou, Z., Yu, A., & Chen, J. (2022). Coarse-grained CFD-DEM study of Gas-solid flow in gas cyclone. *Chemical Engineering Science*, 260, 117906.
- [22] Pandey, S., & Brar, L. S. (2022). On the performance of cyclone separators with different shapes of the conical section using CFD. *Powder Technology*, 407, 117629.
- [23] El-Emam, M. A., Zhou, L., & Omara, A. I. (2023). Predicting the performance of aero-type cyclone separators with different spiral inlets under macroscopic bio-granular flow using CFD-DEM modelling. *Biosystems Engineering*, 233, 125-150.
- [24] Brar, L. S., Sharma, R. P., & Elsayed, K. (2015). The effect of the cyclone length on the performance of Stairmand high-efficiency cyclone. *Powder Technology*, 286, 668-677.
- [25] Shaheed, R., Mohammadian, A., & Kheirkhah Gildeh, H. (2019). A comparison of standard  $k-\epsilon$  and realizable  $k-\epsilon$  turbulence models in curved and confluent channels. *Environmental Fluid Mechanics*, 19, 543-568.





**XIII International Conference Industrial  
Engineering and Environmental  
Protection 2023 (IIZS 2023)  
October 05-06, 2023, Zrenjanin, Serbia**

---

**Session 2**

**Energetics and Process  
Technique**



## THERMODYNAMIC ANALYSIS OF A SOLAR WALL SYSTEM FOR AIR HEATING AND ENERGY STORAGE

Snežana Dragičević<sup>1</sup>

<sup>1</sup>University of Kragujevac, Faculty of Technical Sciences in Čačak, Serbia  
e-mail: [snezana.dragicevic@ftn.kg.ac.rs](mailto:snezana.dragicevic@ftn.kg.ac.rs)

**Abstract:** In this paper, the thermodynamic analysis of a solar wall air heating system featuring a central duct filled with heat storage material is presented. The analyzed system comprises a double-glazing structure and a substantial wall incorporating an opening with a central duct, which is filled with heat storage material. To enhance its operational efficiency, a fan is positioned at the lower vent of the wall. A one-dimensional steady-state mathematical model is developed to simplify the analytical assessment of the air heating system's effectiveness within the active solar wall. This model accounts for the simultaneous heating of the air in the room and energy accumulation. Subsequently, the acquired data are analyzed to forecast the potential impacts of operational and environmental parameters on the thermal efficiency of the system.

**Key words:** solar wall, thermodynamic model, air heating, energy storage

### INTRODUCTION

Energy is the primary driver of technological advancement. Historically, humanity's utilization of energy sources evolved slowly over thousands of years. In the last century, primarily due to industrialization and population growth, the demand for energy has exponentially increased year by year. In the past few decades, at the beginning of the new millennium, renewable energy sources, especially solar energy, have played an increasingly significant role in global energy production.

In the era of increasing environmental awareness and the pursuit of sustainable energy solutions, the utilization of solar energy for indoor air heating has gained prominence as a subject of significant scholarly interest and practical relevance. This paradigm shift underscores the recognition of the advantages offered by solar-based heating systems, particularly in their capacity to reduce environmental impact and enhance energy efficiency within confined spaces. The application of solar energy to meet the indoor heating demands of residential, commercial, and industrial spaces represents a pivotal convergence of renewable energy utilization and improved indoor environmental quality.

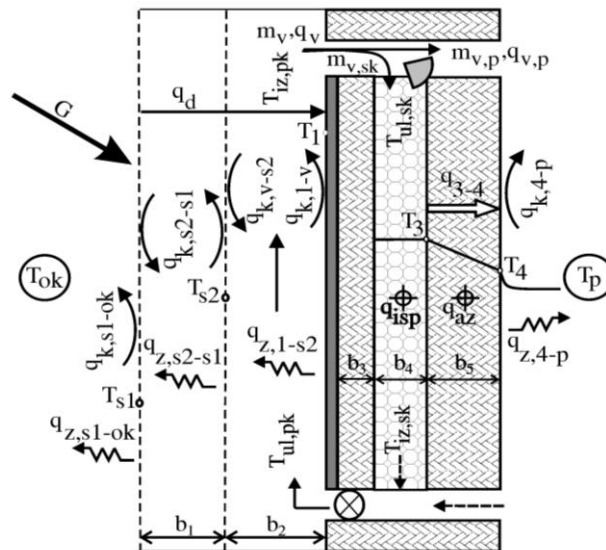
Solar space heating systems rely on the use of massive solar walls covered with transparent coatings, whose radiated surface has good absorption characteristics and the wall mass possesses significant heat storage capacity. The massive active solar wall could be constructed with a central duct within the wall [1-3]. This construction allows for a faster and more efficient transfer of heat from the receiving space, where significant heat losses occur, to the central part of the wall, which can be constructed with or without fill material. The circulation of heated air from the receiving space to the central duct can be natural (thermosiphon) or forced, requiring the installation of fans in the wall opening.

Solar walls have been the subject of extensive experimentation and research investigations. Numerous theoretical and empirical studies have substantiated the enhancement of indoor comfort attributed to well-designed solar walls [4-6]. Given the increasing prominence of massive solar walls in the context of space heating applications, it becomes imperative to undertake precise testing procedures aimed at evaluating the optimal wall parameters conducive to achieving energy efficiency operating conditions. In this paper, a thermodynamic analysis has been performed on a solar wall featuring a central duct filled with energy-storing material. Analyzed configuration of the solar wall is employed for both concurrent air space heating and energy storage within the wall.

## MATERIAL AND METHODS

### Heat transfer analysis

The analyzed model of a solar wall for space heating, with simultaneous heat accumulation in the inner layers of the wall and the filling material of the central duct, is illustrated in Figure 1. The material used to fill the central duct of the wall can be in the form of solid pieces, homogeneous material, or a combination of both. It is important for the surface of the filling material in contact with heated air to be as large as possible, as this results in a greater contact surface area for heat exchange within the given volume. By using smaller-sized granules, a more even distribution of hot air contact is ensured throughout the filling, accommodating a larger mass within a specific volume. After a certain period of heat accumulation, there is also a more even temperature distribution of the filling material. If homogeneous material is used for filling, it results in a smaller contact surface area for heat exchange, and it takes more time to heat these pieces to their depth.



**Fig. 1.** Active solar wall with a filled duct space  
 - simultaneous airflow to the central duct and the heated room -

The utilization of this solar wall model facilitates enhanced heat accumulation within the inner wall layers and a more even temperature distribution along the wall. Thermodynamic analysis was carried out for the wall exposed to global solar radiation  $G$ , while the room air temperature is maintained at  $T_p$ .

The characteristic temperatures, given in Figure 1, are as follows:

- $T_{ok}$  - ambient air temperature
- $T_1$  - absorber temperature
- $T_3$  and  $T_4$  - temperatures of the boundary surfaces inside the wall
- $T_{s1}$  and  $T_{s2}$  - glass cover temperatures
- $T_{ul,pk}$  and  $T_{iz,pk}$  - temperatures at the inlet and outlet of the receiving duct of the wall
- $T_{ul,sk} = T_{iz,pk}$  and  $T_{iz,sk}$  - temperatures at the inlet and outlet of the central duct of the wall.

Heat exchange between structural elements of the wall occurs through conduction, convection and radiation. When considering the heat effects of solar radiation during the heating phase of the wall, the amount of heat carried by the heated air from the receiving duct to the central duct of the wall is distributed as follows:

- $q_{isp}$  - a portion of the heat is absorbed by the material in the central duct
- $q_{az}$  - a portion is absorbed within the inner part of the solar wall
- $q_{3-4}$  - some of the heat is conducted through the inner wall towards the heated room

- The remaining heat is returned from the central to the receiving duct of the solar wall. The energy potential of the return air stream from the heated room is negligible compared to the potential of the air flowing through the receiving duct. Therefore, the heat flux of the return air stream can be disregarded in energy balances.

### Thermodynamic model

A thermodynamic model is established for cases where the temperature within the heated room falls below a specified level, prompting the need for the circulation of warm air into the room. The geometrical, thermo-physical and operational parameters of the system are:

- Double glass glazing unit:  $b_1=b_2=10$  cm
- Solar wall parameters:  $\rho_z=2400$  kg/m<sup>3</sup>,  $\rho_{isp}=1840$  kg/m<sup>3</sup>,  $c_{isp}=800$  J/kgK,  $H=2.7$ m,  $Y=3$ m,  $\lambda_z=0.9$  W/mK,  $b_3=b_4=5$  cm,  $b_5=10$  cm
- Ambient conditions:  $t_{ok}=0^\circ\text{C}$ ,  $w_v=0$  m/s.

The mass and energy balance equations for the solar wall model shown from Figure 1 are as follows:

$$m_v = m_{v,p} + m_{v,sk} \quad (1)$$

$$m_v = \frac{2}{3} w_o \rho_v b_2 Y \quad (2)$$

$$q_v = q_{v,p} + q_{isp} \quad (3)$$

where are:

$m_v$  [kg/m<sup>3</sup>] mass flow rate of air through the receiving duct of the wall;

$m_{v,p} = \xi m_v$  [kg/m<sup>3</sup>] mass flow rate of air flowing from the receiving duct of the wall into the heated room;

$\xi \in (0 \div 1)$  the coefficient that defines the mass flow rate of air from the receiving duct to the heated room;

$m_{v,sk} = (1 - \xi) m_v$  [kg/m<sup>3</sup>] mass flow rate of air flowing from the receiving duct to the central duct of the wall;

$w_o$  [m/s] the air velocity at the inlet of the entrance duct;

$q_v$  [W/m<sup>2</sup>] heat flux carried by the heated air from the receiving duct;

$q_{v,p} = \xi q_v$  [W/m<sup>2</sup>] heat flux that the heated air from the receiving duct transfers to the air in the heated room;

$q_{isp} = (1 - \xi) q_v$  [W/m<sup>2</sup>] heat flux that the heated air carries from the receiving duct to the accumulating material in the central duct of the wall.

The heat flux that the heated air carries from the receiving duct can be calculated from the following equation:

$$q_v = h_{p,k} (T_1 + T_{s2} - T_{ul,pk} - T_{iz,pk}) = h_{p,k} \left\{ \left[ \frac{1}{2} (T_1 + T_{s2}) - T_{ul,pk} \right] \left( 1 + e^{-\frac{3h_{p,k}H}{c_p \rho_v w_o b_2}} \right) \right\} \quad (4)$$

$$h_{p,k} = 2.27 \left( \frac{w_o}{b_2} \right)^{0.5} \quad (5)$$

$$T_{iz,pk} = \frac{1}{2} (T_1 + T_{s2}) (1 - e^{-\theta}) + T_{ul,pk} e^{-\theta} \quad \theta = \frac{6.81H}{c_p \rho_v w_o^{0.5} b_2^{1.5}} \quad (6)$$

where  $h_{p,k}$  [W/m<sup>2</sup>K] represents heat transfer coefficient in the receiving duct of the wall.

In the analyzed solar wall model, heat can accumulate in the inner part of the wall and in the material filling the central duct because it is assumed that the external part of the wall is of

small thickness and does not have significant energy storage capacity. The energy balance for the air flowing through the central duct of the wall is as follows:

$$q_{sk} = q_{isp} + q_{az} + q_{3-4} \quad (7)$$

$$(1 - \xi) \frac{2}{3} \rho_v w_o b_2 Y c_p (T_{ul,sk} - T_{iz,sk}) \tau = \rho_{isp} b_4 Y Z \zeta c_{isp} (T_{isp,\tau} - T_{isp,o}) + \rho_z b_4 Y Z c_z (T_{z,\tau} - T_{z,o}) + \frac{\lambda_z}{b_5} (T_3 - T_4) Y Z \tau \quad (8)$$

where are  $T_{isp,\tau}$  represents temperature of the material fills up after the observed time of heat transfer.

Simplifications of the mathematical model are:

- The initial average temperature of the filling material, as well as that of the inner wall section, is presumed to be equal to the air temperature in the room:  $T_{isp,o} = T_{z,o} = T_p$ ;
- The average temperature of the filling material, following the observed time period of heat transfer, is identical to the temperature of the exterior surface of the inner wall section  $T_{isp,\tau} = T_3$ ;
- The average temperature of the inner part of the wall after the observed time period of heat transfer is calculated as  $T_{z,\tau} = (T_3 + T_4)/2$ .

The thermal efficiency of the system, which represented the ratio of the useful heat gain to the global solar power received by the wall, can be expressed using next equation:

$$\eta = \frac{q_{v,p} + q_{4-p}}{q_G + \varepsilon_v} \quad (9)$$

where are:

$q_G = \tau \alpha G$  [W/m<sup>2</sup>] the heat flux incident upon the absorber due to solar radiation;

$q_G$  transmittance-absorptance product for the glass cover-absorber system;

$\varepsilon_v$  [W/m<sup>2</sup>] electrical energy consumed for the fan operation;

$q_{4-p}$  [W/m<sup>2</sup>] heat flux transferred through the inner part of the wall to the room air, through radiation and convection, can be calculated using the following equation:

$$\frac{\lambda_z}{b_5} (T_3 - T_4) = 11.24 \frac{(T_4 - T_p)^{1.33}}{T_p^{0.33}} + \varepsilon_z \sigma (T_4^4 - T_p^4) \quad (10)$$

where  $\varepsilon_z = 0.95$  is emissivity coefficient of the wall material, and  $\sigma = 5.67 \cdot 10^{-8}$  [W/m<sup>2</sup>K<sup>4</sup>] Stefan-Boltzmann constant.

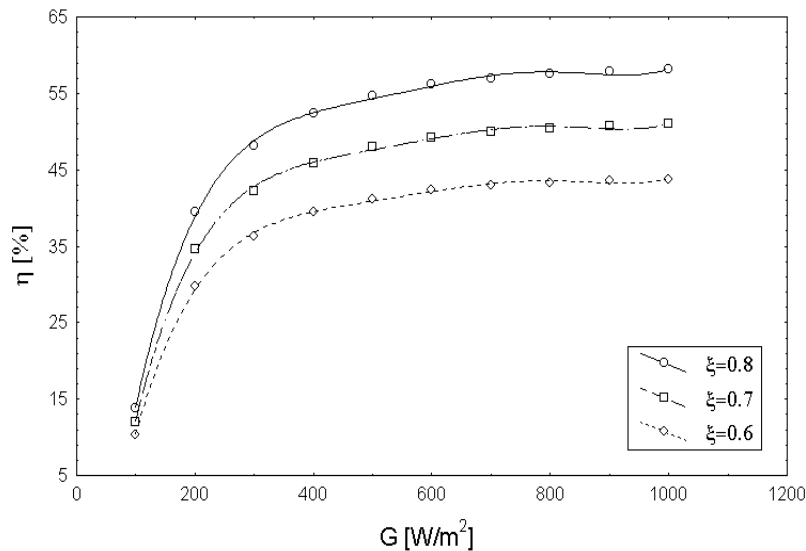
Following the development of the mathematical model for the solar air heating system designed for simultaneously air heating and energy storage within the interior section of the wall, a series of numerical simulations has been carried out to evaluate the efficiency of the proposed air solar heating system.

## RESULTS AND DISCUSSION

The thermal analysis of such a system presents a significant complexity due to the potential variations in construction, operational, and environmental parameters. Consequently, in the efficiency studies conducted on the presented solar wall system, certain parameters are held constant, while the impact of two specific parameters is subject to accurate analysis [7].

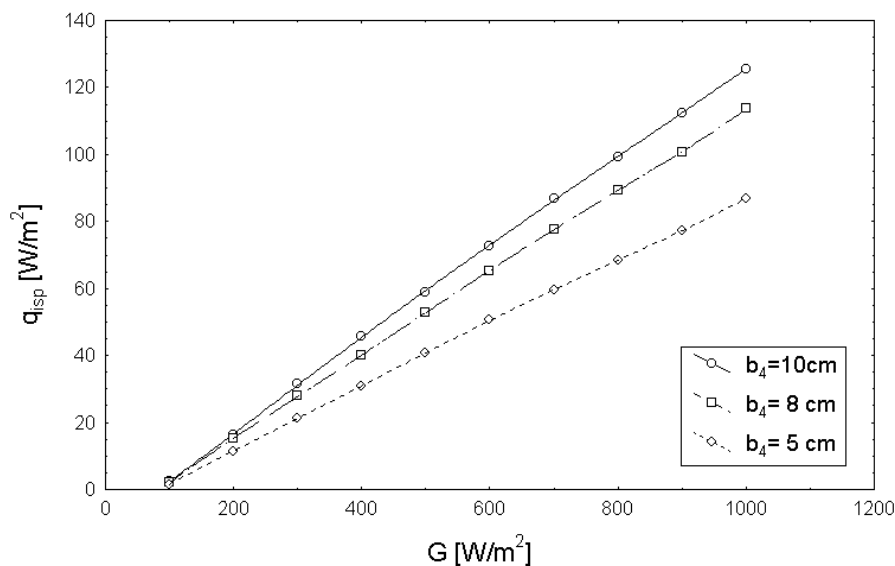
The influence of global solar radiation intensity on the efficiency of the system for different mass flow rates of air flowing from the receiving space to the heating room is depicted in Figure 2. As the global solar radiation increases, the heat flux leaving the receiving duct and heating the air in the heating room also increases, leading to a higher thermal efficiency of the heating

system. The figure also illustrates that with an increase in the flow coefficient of the heated air from the receiving duct to the room, the thermal efficiency of the analyzed heating system increases. The thermal efficiency of the wall increased with a mass flow rate up to 57 %. The impact of these parameters on the system efficiency is more pronounced for global solar radiation values up to 600 W/m<sup>2</sup>, as the efficiency of the system remains approximately constant for higher values of solar radiation for the analyzed parameters.



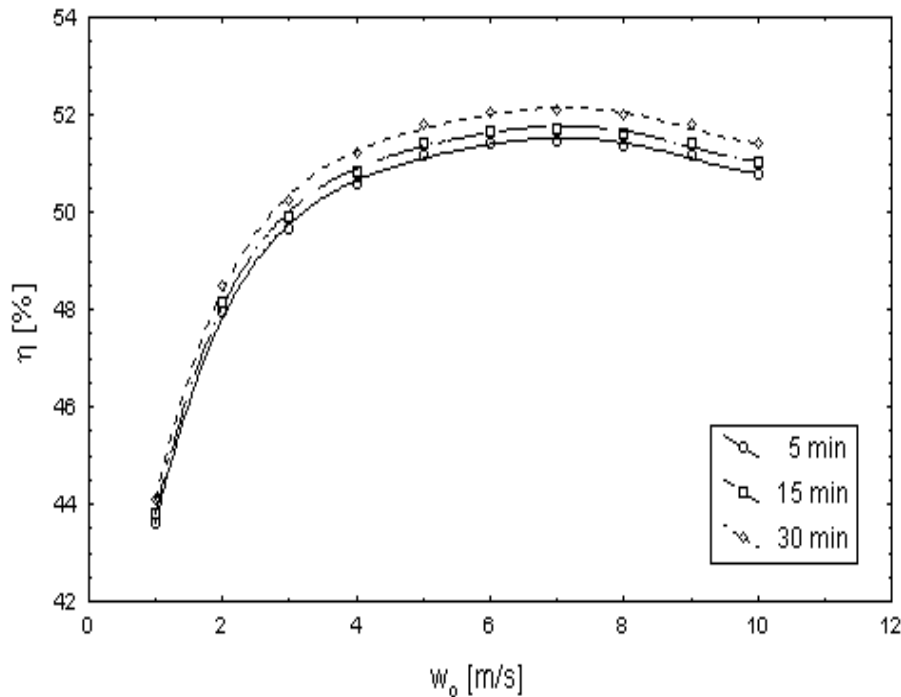
**Fig. 2.** Variation in the thermal efficiency of the solar wall with a global solar radiation for different air mass flow rate coefficient  $\xi$ ,  $w_o = 1 \frac{m}{s}$ ,  $\tau = 15 \text{ min}$

The influence of the width of the central duct of the wall on the intensity of heat flux that the heated air carries from the receiving duct to the accumulating material in the central duct of the wall, for different values of global solar radiation is shown in Figure 3. The simulation results of the system operation indicate an increase in the heat flux accumulated in the filling material as global solar radiation increases. For a specific intensity of global solar radiation, the heat flux is greater when the width of the central duct of the wall is larger.



**Fig. 3.** Variation in the heat flux accumulated in the filling material in the central duct with a global solar radiation, for different width of the central duct  $b_4$ ,  $w_o = 1 \frac{m}{s}$ ,  $\tau = 15 \text{ min}$ ,  $\xi = 0.6$

The influence of the time period of heat transfer on the thermal efficiency is depicted in the diagram shown in Figure 4. The figure illustrates that for a longer time period of heat transfer, the thermal efficiency is higher, and vice versa. The thermal efficiency of the system increases with the increase in the air flow rate at the inlet of the receiving duct up to a velocity of 6 m/s, after which it slightly decreases. The results show that the maximum thermal efficiency of the system for the analyzed parameters is 52%.



**Fig. 4.** Variation in the thermal efficiency with the air velocity at the inlet of the entrance duct, for different time of heat transfer,  $G = 1000 \frac{W}{m^2}$ ,  $\xi = 0.6$

## CONCLUSION

The findings from this study provide valuable insights into the effectiveness of air heating using an active solar wall featuring a central duct, under various operating and environmental conditions. The active solar wall model under analysis serves the dual purpose of heating the room and storing energy when exposed to sunlight. The optimization results for this active solar wall model were obtained while maintaining the room's air temperature at 20 °C.

The findings presented in this study reveal a trend in thermal efficiency concerning the impact of solar radiation levels and inlet air velocity on a solar wall system designed for air heating in enclosed spaces. Notably, there is a substantial increase in thermal efficiency as solar radiation levels elevate from 100 to 600 W/m<sup>2</sup>. Additionally, increase in inlet air velocity at the entrance duct correlates with improved thermal efficiency. It is observed that for the analyzed duration of heat transfer, air velocities of up to 4 m/s result in a significant efficiency boost, after which the efficiency remains relatively stable. The examined solar wall model, engineered for space heating purposes, incorporates a central channel filled with an accumulating material. Notably, the width of this central channel exhibits a linear relationship with the heat flux accumulated within the filling material, elucidating an important parameter for system optimization.

This analysis provides users with the means to evaluate the thermal efficiency and heat fluxes of the solar wall air heating system. Results show comparative analyses and predictive modeling of the thermal performance of the presented solar wall under diverse operational conditions.



## ACKNOWLEDGEMENTS

This study was supported by the Ministry of Education, Science and Technological Development of the Republic of Serbia, and these results are parts of the Grant No. 451-03-68/2023-14/200132 with University of Kragujevac - Faculty of Technical Sciences Čačak, Serbia.

## REFERENCES

- [1] Szyszka, J., Bevilacqua, P., Bruno, R., An Innovative Trombe Wall for Winter Use: The Thermo-Diode Trombe Wall, *Energies*, 13, 2188; doi:10.3390/en13092188, 2020.
- [2] Yuewei Zhu, Y., Zhang, T. Ma, Q., Fukuda, H., Thermal Performance and Optimizing of Composite Trombe Wall with Temperature-Controlled DC Fan in Winter, *Sustainability*, 14, 3080. <https://doi.org/10.3390/su14053080>, 2022.
- [3] Abbas, E., Al-abady, A., Raja, V., AL-bonsrulah, H., Al-Bahrani, M., Effect of air gap depth on Trombe wall system using computational fluid dynamics, *International Journal of Low-Carbon Technologies*, Vol. 17, pp. 941–949, 2022.
- [4] Briga-Sa, A., Boaventura-Cunha, J.,Lanzinha, J.C., Paiva, A., Experimental and analytical approach on the Trombe wall thermal performance parameters characterization, *Energy and Buildings*, Vol. 150, pp. 262-280, 2017.
- [5] Kunelbayev, M., Bigaliyeva, Z., Tuleshov, Y., Ibekeyev, S., Kerimkulov, D., Thermodynamic Analysis of an Experimental Model of a Solar-Heat Supply System, *Processes*, Vol. 11, No. 2, 451, 2023.
- [6] Shen, X., Li, N., Lu, J., Yongga, A., Heating Performance of Solar Building Integrated Wall under Natural Circulation, *Energies*, Vol. 13, 6288, 2020.
- [7] Mokni, A., Lashin, A., Ammar, M., Mhiri, H., Thermal analysis of a Trombe wall in various climatic conditions: An experimental study, *Solar Energy*, Vol. 243, No. 1, pp. 247-263, 2022.



## TEMPERATURE BEHAVIOR OF THERMAL CONDUCTIVITY OF COMPOUND CRYSTALLINE NANOSTRUCTURES

Dušan I. Ilić<sup>1</sup>, Nikola R. Vojnović<sup>1</sup>, Siniša M. Vučenović<sup>2</sup>, Jovan P. Šetrajčić<sup>3</sup>

<sup>1</sup>University of Novi Sad, Faculty of Technical Sciences, Novi Sad, Vojvodina - Serbia;

<sup>2</sup>University of Banja Luka, Faculty of Sciences and Mathematics, Banja Luka,  
Republic of Srpska – Bosnia and Herzegovina;

<sup>3</sup>Academy of Sciences and Arts of the Republic of Srpska, Banja Luka, Republic of  
Srpska – Bosnia and Herzegovina;

e-mail: [jovan.setrajcic@gmail.com](mailto:jovan.setrajcic@gmail.com)

**Abstract:** We have recently completed the theory for the calculation of thermodynamic properties of some characteristic nanostructures, using the adapted method of two-time temperature-dependent Green's functions. Through the found phonon dispersion law, in this work we determined the thermal conductivity coefficient of the superlattice using the definition of internal and free energy, and then compared their temperature dependence with the thermal conductivity behavior of ultrathin films and bulk crystal structures. For the observed nanostructures at low temperatures, the values of thermal conductivity coefficients are almost equal, but at the same time they are significantly lower than the same values for bulk samples. That result could be useful for the possible expansion of knowledge about the mechanisms of the occurrence of specific conditions in high-temperature superconductors in which their better properties are achieved.

**Key words:** crystals, superlattices, ultrathin films, phonons, energy spectra, thermal conductivity.

### 1. INTRODUCTION

The completed theory adapted for the calculation of physical properties of some characteristic nanostructures, using the methods of quantum statistical, two-time, and temperature-dependent Green's functions with the necessary theory of differential equations, was mentioned in [1–5]. This mathematically much more complicated approach allows us to determine the law of dispersion of elementary excitations in nanostructures characterized by confinement conditions (convoluted dimensional and boundary conditions). These conditions dictate all (drastic) changes in the fundamental properties of substances mainly in the solid state, and among them, probably in the range of the most significant – the properties of high-temperature CuO ceramics. Changes in the dispersion laws of elementary particles in these structures have implications for very significant changes in their macroscopic transport properties. Of the elementary excitations for this problem, the most important are charge carriers (electrons/holes and ions) and thermal vibrations of the crystal lattice – phonons, which will be the focus here.

Elementary particles – mechanical oscillations – phonons are a subsystem always present in the analysis of the system's conducting, semiconducting, or dielectric properties. Accordingly, we will first analyze the kinetics of mechanical vibrations in nanoscopic ultrathin films, which can serve as a basis for the study of other properties of more complex nanostructures. In a sense, this work represents a generalization of previous research [6–11].

We will start from the definition expression for the coefficient of thermal conductivity [12,13]:

$$\kappa = DC\rho_M, \quad (1.1)$$

where  $D$  is diffusion coefficient,  $C$  – specific heat and  $\rho_M$  is the mechanical density of the observed structure. The diffusion coefficient (strictly speaking, it is the diagonal matrix element of the diffusion tensor  $D_{ij}$ ) is determined by the Kubo formula [12]. The temperature dependence of the density of nanostructures is determined by the two-time, temperature-

dependent Green's function method [14]. This method can be used to determine the internal energy and the average value of the square of the molecular displacements. All analyzes are calculated in terms of the presence of specific boundary conditions on their surfaces, which are responsible for the appearance of unusual effects and changes in the basic properties of these structures [11].

## 2. CALCULATION OF THE DIFFUSION COEFFICIENT

In order to determine the diffusion coefficient, we will start from the Kubo formula [12,13]:

$$D_{ij} = \frac{1}{\beta} \int_0^\infty e^{-\varepsilon t} \int_0^\beta d\lambda \langle \hat{v}_i(-i\hbar\lambda) \hat{v}_j(t) \rangle \approx \lim_{\varepsilon \rightarrow 0} \int_0^\infty e^{-\varepsilon t} \langle \hat{v}_i(0) \hat{v}_j(t) \rangle dt, \quad (2.1)$$

where  $\hat{v}_i$  and  $\hat{v}_j$  ( $i, j = x, y, z$ ) are the velocity operators in Heisenberg representation,  $\varepsilon$  is the perturbation parameter and the averages will be taken over great canonical ensemble. We will find the correlation function  $\langle \hat{v}_i(0) \hat{v}_j(t) \rangle$  through the Green's function  $\langle\langle p_i(t) | p_j(0) \rangle\rangle$ , where  $p_i(t), p_j(0)$  represent the components of the molecular momentum.

The Hamiltonian of the phonon subsystem of a superlattice with two motifs a and b (two ultrathin films) taken in harmonic and nearest neighbor's approximation [14], can be written as follows:

$$H = T + V_p + V_B; \quad T = \sum_{n,\alpha} \sum_{n_i=0}^{n_a-1} \frac{[p_{n,n_i,\alpha}^{(a)}]^2}{2M_a} + \sum_{n,\alpha} \sum_{n_i=n_a}^{n_a+n_b-1} \frac{[p_{n,n_i,\alpha}^{(b)}]^2}{2M_b}; \quad (2.2)$$

where  $M_{a/b}$  are the masses of molecules in first/second ultrathin films,  $V_{P/B}$  are the potential energies of surface and bulk terms,  $p \equiv M \dot{u}$  ( $u$  are molecular displacements) and  $n_{a/b}$  are numbers of molecule in corresponding motive. The boundary conditions are considered in the formation of a system of equations that defines the Green's function of the system.

We have determined the following Green's function, which will be written in the next form:  $G_{n_x n_y n_z f, m_x m_y m_z g} = \langle\langle p_{n_x n_y f}(t) | p_{n_x n_y f}(0) \rangle\rangle$ . Because of valid relation:  $p_i = M v_i$ ;  $v_i = du_i/dt$ , in the expression determining this function, appears the second Green's function of a type  $\langle\langle u_{n_x n_y f}(t) | u_{n_x n_y f}(0) \rangle\rangle$  [15]. In this way, the correlation function of the Green's function is given by a general formula [16,17]:

$$\langle p_f(t) p_f(0) \rangle = \lim_{\varepsilon \rightarrow +0} \int_{-\infty}^{+\infty} d\omega e^{-i\omega t} \frac{G_f(\omega + i\varepsilon) - G_f(\omega - i\varepsilon)}{e^{\hbar\omega/\theta} - 1}. \quad (2.3)$$

Green's function can be expressed as a sum of elementary fractions [15]. In this way we obtain the correlation function (2.3), i.e. corresponding velocity correlation function:

$$\langle v_f(t) v_f(0) \rangle = \frac{\hbar C_H}{M^2 \omega_k} \left( \frac{e^{-i\omega_k t}}{e^{\hbar\omega_k/\theta} - 1} - \frac{e^{i\omega_k t}}{e^{-\hbar\omega_k/\theta} - 1} \right). \quad (2.4)$$

In accordance with the general formula (2.2) the diffusion coefficient is given by:

$$D_{ii}(k) = \left| \frac{\hbar C_H}{M^2 \omega_k} \int_0^\infty \left( \frac{e^{-i\omega_k t}}{e^{\hbar\omega_k/\theta} - 1} - \frac{e^{i\omega_k t}}{e^{-\hbar\omega_k/\theta} - 1} \right) dt \right| = \frac{\hbar C_H}{M^2 \omega_k^2}. \quad (2.5)$$

It is seen that the phonon diffusion coefficient of the superlattice, as well that of the bulk, do not depend on temperature [18].

## 3. THERMODYNAMIC BEHAVIOUR OF SUPERLATTICE

Internal energy of the system is given by the standard formula [16-18]:

$$U_s = \frac{3}{(2\pi)^3} Na^3 \int_0^{2\pi} d\varphi \int_0^\pi \sin \theta d\theta \int_0^{k_M} dk k^2 \hbar \Omega ka \left( e^{\frac{\hbar \Omega ak}{\theta}} - 1 \right)^{-1}, \quad (3.1)$$

where the phonon dispersion law is given by the basic formula:  $E_k = \hbar \Omega ak$ . Phonon reduced frequencies and intermolecular distance are expressed through the geometric mean of phonon frequencies, i.e. of intermolecular distances in separate motifs:

$$\Omega = \sqrt{\frac{C_a}{M_a} \frac{C_b}{M_b}}; \quad a = \sqrt{a_a a_b}. \quad \text{Quantity } \theta = k_B T \text{ is thermodynamic temperature.}$$

After partial integration in (3.1) and introducing notations:  $\Delta_m \equiv E_k|_{k=k_M} = \hbar \Omega a k_M$ , we obtain the following expression:

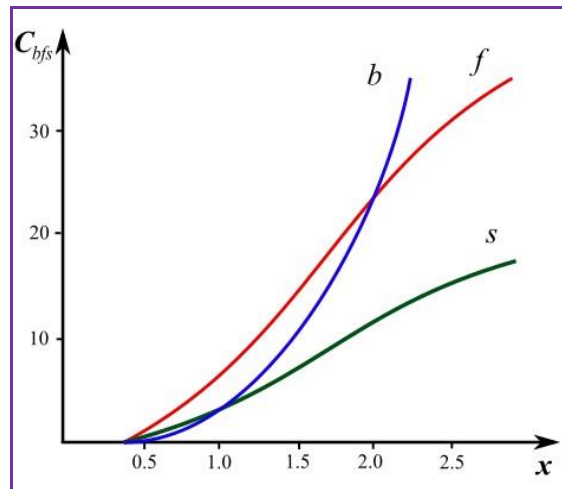
$$U_s = \frac{3N}{2\pi^2} \theta \left\{ 6\zeta(4) \frac{\theta^3}{(\hbar \Omega)^3} - \left[ a^3 k_M^3 Z_1\left(\frac{\Delta_m}{\theta}\right) + 3 \frac{\theta}{\hbar \Omega} a^2 k_M^2 Z_2\left(\frac{\Delta_m}{\theta}\right) + 6 \left(\frac{\theta}{\hbar \Omega}\right)^2 a k_M Z_3\left(\frac{\Delta_m}{\theta}\right) + 6 \left(\frac{\theta}{\hbar \Omega}\right)^3 Z_4\left(\frac{\Delta_m}{\theta}\right) \right] \right\}. \quad (3.2)$$

Since the specific heat is given by  $C_{vs} \equiv C_s = \frac{k_B}{N} \frac{\partial U}{\partial \theta}$  using (3.2) we find that:

$$C_s = \frac{3k_B}{2\pi^2} \left\{ a^3 k_M^3 \frac{\Delta_m}{\theta} \frac{1}{1 - e^{-\Delta_m/\theta}} - 4a^3 k_M^3 Z_1\left(\frac{\Delta_m}{\theta}\right) - 12 \frac{\theta}{\hbar \Omega} a^2 k_M^2 Z_2\left(\frac{\Delta_m}{\theta}\right) - 24 \left(\frac{\theta}{\hbar \Omega}\right)^2 a k_M Z_3\left(\frac{\Delta_m}{\theta}\right) + 24 \left(\frac{\theta}{\hbar \Omega}\right)^3 \left[ \zeta(4) - Z_4\left(\frac{\Delta_m}{\theta}\right) \right] \right\}. \quad (3.3)$$

Temperature dependence of the thermal capacity is determined by two specific terms. First term is:  $\approx (1 - e^{-\Delta_m/\theta})^{-1} / \theta$  which is "responsible" for behavior of the system at low and high temperatures. Second term containing Z-functions characterizes temperature behavior in middle-temperature range.

Based on the results of previous research on the phonon contribution to the thermodynamic behavior of the ultrathin film structures [6–8] and the known behavior of the bulk [12,16–18], Fig.1 shows a comparative plot of the specific heat for the superlattice, ultrathin film, and the bulk structures in dependence of reduced temperature:  $x = \theta/\Delta_m$ .



**Fig. 1.** Specific heats of bulk (b), films (f) and superlattice (s) structures

From Fig.1, we can conclude that the behavior of the thermal capacitance of the superlattice in the low-temperature range is similar to that of the bulk. The temperature behavior of the thermal capacitance of superlattice in the medium temperature range is similar to that of film. The difference in these capacitances is most pronounced in the high-temperature range. Now we will approach the determination of the temperature behavior of the thermal conductivity of the superlattice. The expression for the dynamic density of the superlattice:

$$\rho_M = \frac{M}{\langle (a_0 + u)^3 \rangle} = \frac{M}{\langle a_0^3 \rangle} \frac{1}{1 + 3 \langle u^2 \rangle \langle a_0^2 \rangle^{-1}} \approx \rho_0 \left( 1 - \frac{3 \langle u^2 \rangle}{\langle a_0^2 \rangle} \right) \quad (3.4)$$

The averages of squares of displacements for molecular superlattices we can find as in the Debye's representation. After integration, the expression for the density becomes:

$$\rho_M = \rho_0 \left( -1 + \frac{9}{2\pi^2} \frac{\hbar(n_a + n_b)}{a^2 \omega_D M} \frac{\theta}{\hbar\Omega} \left\{ (ak_M)^2 Z_1\left(\frac{\Delta_M}{\theta}\right) + 2ak_M \frac{\theta}{\hbar\Omega} Z_2\left(\frac{\Delta_M}{\theta}\right) + 2\left(\frac{\theta}{\hbar\Omega}\right)^2 \left[ Z_3\left(\frac{\Delta_M}{\theta}\right) - \zeta(3) \right] \right\} \right) \quad (3.5)$$

Diffusion coefficient is given by the relation (2.5), where:

$$\langle \omega_k \rangle = \frac{1}{I_0} \int_0^{2\pi} d\varphi \int_0^\pi \sin \theta d\theta \int_0^{k_M} dk \omega(k); \quad I_0 = \int_0^{2\pi} d\varphi \int_0^\pi \sin \theta d\theta \int_0^{k_M} dk k^2 \quad (3.6)$$

are the average value phonon frequencies. After elementary calculations we obtain for the diffusion coefficient:

$$D = \frac{16}{9} \frac{\hbar}{M} \frac{1}{a^2 k_M^2} = \frac{16}{9} \frac{\hbar}{M} \left[ \frac{2}{3} k_D^2 + (k_z^{\max})^2 \right]^{-1} \quad (3.7)$$

and we reduce the expression (1.1) for thermal conductivity coefficient to the form:

$$\kappa = \frac{8}{3} \frac{\hbar k_B a k_M}{\pi^2 a^3} J_1(x) J_2(x), \quad (3.8)$$

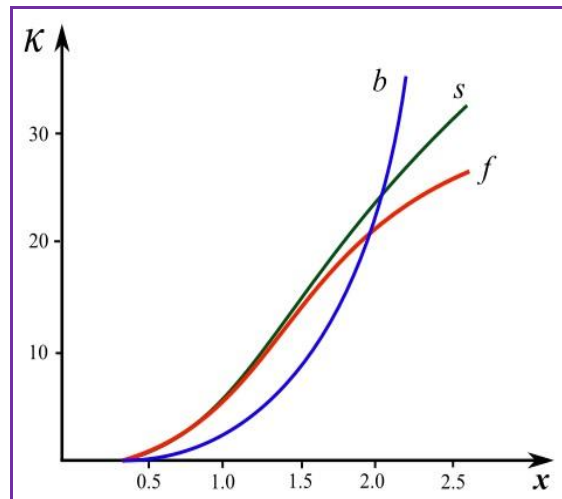
where

$$J_1(x) = \frac{\delta}{x} \frac{1}{1 - e^{\delta/x}} - 4Z_1(\delta/x) - 12 \frac{x}{\delta} Z_2(\delta/x) - 24 \left(\frac{x}{\delta}\right)^2 Z_3(\delta/x) + 24 \left(\frac{x}{\delta}\right)^3 [\zeta(4) - Z_4(\delta/x)], \quad (3.9)$$

$$J_2(x) = 1 + \frac{9}{2\pi^2} \frac{\hbar(n_a + n_b)}{a^2 \omega_D M} (ak_M)^3 \frac{x}{\delta} \left\{ Z_1(\delta/x) + 2 \frac{x}{\delta} Z_2(\delta/x) + 2 \left(\frac{x}{\delta}\right)^2 [Z_3(\delta/x) - \zeta(3)] \right\}$$

The temperature dependence of the thermal conductivity coefficient is determined by two specific terms. Similar to the expression for the heat capacity, here the first term:  $\approx (1 - e^{\Delta_m/\theta})^{-1} / \theta$ , which is "responsible" for the behavior of the system at low and high temperatures. The second term, which contains Z-functions, also characterizes the temperature behavior in the medium temperature range. A graphical representation of the dependence of the relative thermal conductivity coefficient  $\kappa / \kappa_0 \equiv \lambda = 2.13 J_1(x) J_2(x)$  on the scaled temperature  $x = \theta/\theta_D$  is given on the Fig. 2.

From Fig.2 it can be concluded that the thermal conductivity coefficient of the superlattice is similar to that of the ultrathin film (it is higher than that of the bulk structure). The difference is more pronounced in the medium and high-temperature ranges. It can be concluded that the superlattices are slightly better heat conductors than the bulk structures in the low-temperature range. At the same time, the thermal conductivity of the film is higher than that of superlattices. On the other hand, superlattices in the high-temperature range are much better thermal insulators than film structures and the corresponding infinite crystal structures.



**Fig. 2.** Conductivity coefficient of bulk (b), films (f) and superlattice (s) structures

#### 4. CONCLUSION

The results obtained here show that the thermal conductivity coefficients of the film and the superlattice at low and high temperatures are significantly lower than the thermal conductivity coefficient of the corresponding bulk structures, where the dependence of the thermal coefficient on temperature is  $\sim T^3$ . This result is also applicable in practice: a sandwich of several films would be a better thermal insulator than a bulk structure of the same thickness. The theoretical results presented here are compared with experimental data [19–22]. It is obvious that there is a satisfactory agreement between our and experimental facts. According to the Viedeman-Frantz rule, the electrical conductivity is proportional to the thermal conductivity. This leads to the conclusion that films and superlattices are weaker electrical conductors than bulk structures of the same material at low and high temperatures. For future research, it would be interesting to evaluate the superconducting properties of the observed structures. The general behavior of current materials shows that the worse the conductors are in the room temperature range, the better the superconductors are in the low (cryogenic) temperature range. In this way, the ultrathin films and superlattices could be structures with high superconducting potential, not only for the low-temperature range, but also for the high-temperature range.

#### ACKNOWLEDGEMENT

The research presented in this paper was financially supported by the Ministry of Scientific and Technological Development, Higher Education and Information Society of the Republic of Srpska (Projects No. 19.032/961-36/19 and 19.032/961-42/19) and by the Ministry of Science, Technological Development and Innovation through Project no. 451-03-47/2023-01/200156 "Innovative scientific and artistic research from the FTS (activity) domain".

#### REFERENCES

- [1] Sajfert, V.D., Šetrajčić, J.P., Application of Green's Functions and Difference Equations in Theoretical Analyses of Nanostructures, In: "Series on the Foundations of Natural Science and Technology", ISSN: 2010-1961, Eds. C. Politis, W. Schommers and E. Meletis, Vol. 15: "Topics in Nanoscience, Part I: Basic Views, Complex Nanosystems: Typical Results and Future", ISBN 978-981-124-267-0, Ed. W. Schommers, Ch. 7, pp. 311-412; World Scientific, Singapore 2022, <https://doi.org/10.1142/12419-vol1>.
- [2] Šetrajčić, J.P., Ilić, D.I., Jaćimovski, S.K., The influence of the surface parameter changes onto the phonon states in ultrathin crystalline films, Physica A Vol. 496, 434–445 (2018), <https://doi.org/10.1016/j.physa.2017.12.138>.

- [3] Jaćimovski, S.K., Tošić, B.S., Šetrajčić, J.P., Sajfert, V.D., Charge tunneling in doped quantum rod, *Int. J. Mod. Phys. B* Vol. 24(27), pp. 5345–5358, 2010; doi: 10.1142/S0217979210054725.
- [4] Tošić, B.S., Šetrajčić, J.P. and Jaćimovski, S.K., *Methods of Theoretical Physics*, Ch. 7, University of Criminal Investigation and Police Studies, Belgrade 2018 (in Serbian).
- [5] Šetrajčić, J.P., Jaćimovski, S.K., Sajfert, V.D., *Phonon Engineering Theory Of Crystalline Layered Nanostructures*, ISBN: 978-3659-80775-6, LAP Lambert Academ.Publ., Saarbrücken (Germany) 2015.
- [6] Šetrajčić, J.P., Mirjanić, D.Lj., S.M.Vučenović, Ilić D.I., Markoski, B., Jaćimovski, S.K., Sajfert, V.D. and Zorić, V.M., *Phonon Contribution in Thermodynamics of Nano-Crystalline Films and Wires*, *Acta Phys.Pol. A* Vol. 115, pp. 778-782, 2009.
- [7] Šetrajčić, J.P., Zorić, V.M., Deliće, N.V., Mirjanić, D.Lj. and Jaćimovski, S.K., *Phonon Participation in Thermodynamics and Superconductive Properties of Thin Ceramic Films*, Ch. 15, pp. 317-348, In „*Thermodynamics*”, Ed.M.Tadashi, ISBN: 978-953-307-544-0, InTech, Vienna (Austria), 2011.
- [8] Šetrajčić, J.P., Jaćimovski, S.K. and Sajfert, V.D., *Phonon Contribution to Heat Capacitance of Nanolayered Crystalline Structures*, *Mod.Phys.Lett.B* Vol. 29(4), 1550008 [13 pages], 2015, <https://doi.org/10.1142/S0217984915500086>.
- [9] Šetrajčić, J.P., Sajfert, V.D., and Jaćimovski, S.K., *Fundamental Preferences of the Phonon Engineering for Nanostructural Samples*, *Rev.Theor.Sci.* Vol. 4/4, pp. 353-401, 2016, <https://doi.org/10.1166/rits.2016.1067>.
- [10] Šetrajčić, J.P., Jaćimovski, S.K. and Vučenović, S.M., *Diffusion of Phonons Through (Along and Across) the Ultrathin Crystalline Films*, *Physica A* Vol. 486(5), pp. 839-848, 2017, <https://doi.org/10.1016/j.physa.2017.06.003>.
- [11] Šetrajčić, J.P., Ilić D.I. and Jaćimovski, S.K., *The Influence of the Surface Parameter Changes onto the Phonon States In Ultrathin Crystalline Films*, *Physica A* Vol. 496, pp. 434-445, 2018, <https://doi.org/10.1016/j.physa.2017.12.138>.
- [12] Kubo, R.J., *Statistical-Mechanical Theory of Irreversible Processes. II. Response to Thermal Disturbance*, *J.Phys. Soc. Jpn* Vol. 12, 570, 1957.
- [13] V.M.Agranovich, M.D.Galanin, *Migration of Electron Energy Excitations in Condensed Matter*, Nauka, Moskwa, 1978.
- [14] Šetrajčić, J.P. , Jaćimovski, S.K., Sajfert, V.D., *Phonon Engineering Theory of Crystalline Layered Nanostructures*, pp.57, ISBN: 978-3659-80775-6, LAP Lambert Academ.Publ., Saarbrücken (Germany), 2015.
- [15] Šetrajčić, J.P., Jaćimovski, S.K., Vučenović, S.M., *Green's Functions in Quantum Statistical Physics – Condensed Matter Physics*, International Conference on Applied Sciences, Banja Luka. 2022.
- [16] Ishihara, A., *Statistical Physics*, ISBN: 9781483274102, Academic Press, New York, 1971.
- [17] S.V.Tyablikov, *Methods of Quantum Theory in Magnetism*, Nauka, Moscow, 1975.
- [18] Kittel, Ch., *Introduction to Solid State Physics*, Wiley, New York, 1986.
- [19] K.Goodson, *Measurement of the Thermal Conductivity and Heat Capacity of Freestanding Shape Memory Thin Films Using the 3 $\omega$  Method*, *J.Heat Transfer* Vol. 130/10, 102402 (7 pages), <https://doi.org/10.1115/1.2945904>, 2008.
- [20] Santamore, D.H., Cross, M.C., *The Effect of Surface Roughness on Universal Thermal Conductance*, <http://www.lanl.gov/find/cond.mat/>, No: 0011473.
- [21] Nika, D.L., Balandin, A.A., *Phonons and Thermal Transport in Graphene and Graphene-Based Materials*, arXiv:1606.00488 [cond-mat.mtrl-sci], 56 pages, <https://doi.org/10.48550/arXiv.1606.00488>, *Rep.Prog.Phys.* Vol. 80, pp. 036502, 2017.
- [22] Putzke, C., et al. *Layered Metals as Polarized Transparent Conductors*, *Nat. Commun.* Vol. 14, pp. 3147, 2023, <https://doi.org/10.1038/s41467-023-38848-0>.
-





## PRELIMINARY RESULTS ON ENERGETIC POTENTIAL FOR DIFFERENT TYPES OF BIOMASS BASED MATERIALS

**Bacoș Timotei Bogdan<sup>1</sup>, Cioablă Adrian Eugen<sup>1\*</sup>, Luisa Izabel  
Dungan<sup>1</sup>, Aleksandar Djuric<sup>2</sup>**

<sup>1</sup>Politehnica University Timisoara, Mechanical Engineering Faculty, Mihai Viteazu  
Blv, 1, zip code 300222, Timisoara, Romania, [adrian.cioabla@upt.ro](mailto:adrian.cioabla@upt.ro),

[bacost@yahoo.com](mailto:bacost@yahoo.com)

<sup>2</sup>City of Zrenjanin, Trg Slobode 10, post code: 23000 Zrenjanin, Serbia,  
[aleksdz@yahoo.com](mailto:aleksdz@yahoo.com)

**Abstract:** The total mass of all living things on Earth is their biomass. A variety of high-quality products, including chemicals, biofuels, and sophisticated materials, can be made from plant biomass, an abundant renewable resource. Numerous biomass species and processing methods have recently been developed to make greater use of plant biomass. Numerous technologies have been successfully developed as a result of the successful implementation of some of the goods in the industrial sector. Given that plant biomass is the primary source of energy for almost all life forms, its stability in the face of environmental change is essential for maintaining the functioning of terrestrial ecosystems.

**Key words:** biomass, biofuels, production

### INTRODUCTION

Rapid population expansion and industrial development have led to a higher consumption of fossil fuels (coal, oil and natural gas) over the past several decades. Fossil fuels have relatively easy accessibility, compatibility and affordability [1], but they are non-renewable resources that will 1 day be exhausted. Excessive greenhouse gases (such as CO, CO<sub>2</sub>, NO<sub>x</sub>, SO<sub>x</sub>, and CH<sub>4</sub>) are discharged into the atmosphere following the consumption of fossil fuels [2], which has created a man-made climate change problem. Hence, environmentally friendly and renewable alternative energy sources have been explored, among which biomass energy is considered to be a clean energy source and a potential substitute for fossil fuels. As the world's most productive biomass energy, bioethanol is basically produced from food crops rich in starch and sugar, which can cause an imbalance in the food and feed supply chain, challenging the sustainability of the process [3].

Numerous types of biomass feedstocks have been found and are typically categorized into three groups: first generation, second generation, and third generation. This is because of the rapid growth of industry, the rapid rise in population, the surge in energy demand, and the intensification of the greenhouse effect. First generation feedstocks are typically plants that are utilized in the manufacturing of first-generation bioethanol and biodiesel and are high in sugars (sugarcane, sweet sorghum, sugar beet, etc.), starches (corn, wheat, barley, potato, etc.), and oils (olive, palm, sunflower, coconut, etc.). Since these biofuels were the first to be studied, their industrial manufacturing methods are already well-developed, and they have been employed in commercial maritime boats or cars [4,5].

Flax is one of the few plants that are entirely a source of raw materials for further production. Promising directions for the use of flax biomass may be the production of bioenergy in the form of 2G biofuels and the production of "green" composites [6]. The cultivar of flax, *Linum usitatissimum* L., is used for a variety of purposes in agriculture. It is an annual plant having

culinary and medical benefits as well as industrial applications. Linseed, fiber, and dual purpose flax are the three types of flax that are distinguished in cultivation forms [7]. Only 241,103 ha of the 4,384,000 ha of flax that were grown worldwide in 2021 were used for fiber [8]. The enormous production of linseed seeds—which have the greatest alpha-linolenic acid content of any plant—is their primary focus [9,10]. Linseed oil contains approximately 50% of highly saturated fatty acids, primarily linoleic acid and alpha-linolenic acid (omega 3), while flax seeds contain 33–45% fat [11]. The two main summer feed crops for ensiling in tropical and sub-tropical climates, as well as in other climates, are corn (*Zea mays*) and sorghum (*Sorghum vulgare*). High corn yields, superior nutritional value, and outstanding ensiling qualities are advantages [12]. Sorghum has a great tolerance for drought, cheap production costs, and large yields, making it an ideal crop for silage in subtropical climates [13]. Forage corn and sorghum are kept as silage as whole plants. Water-soluble carbohydrates (WSC) are converted into organic acids, primarily lactic acids, by epiphytic lactic acid bacteria (LAB), which is the basis for ensiling. As a result, the pH drops, and the forage is kept intact so long as the silage is airtight. Due to the respiration and activity of unfavorable microorganisms such yeasts and molds, which induce fermentative nutrient losses, air is a major contributor to the deterioration of silage [14].

Microalgae have recently received attention as a third generation feedstock. Utilizing microalgae provides a number of benefits, including increased biomass output and high photosynthetic efficiency [15]. Microalgae may grow anywhere, including in brackish, saltwater water, because they do not compete for lands. The focus of recent international studies and research has been on cultivating algae and increasing the lipid content of microalgae [16–18]. As there is relatively little information in the literature on algal oil and algae biodiesel, more focused efforts are required for complete characterization of algae biomass, algae oil, and algae biodiesel in order to establish the potential of microalgae biomass as an option for producing biodiesel.

## **MATERIALS AND METHODS**

### **Determination of moisture content**

The operations were conducted according to the standard EN ISO 18134 Part 3, which pertains to the determination of moisture content in solid biofuels using the oven dry method. Here's a breakdown of the steps involved:

**Weighing Samples:** Approximately 1 gram of the material was weighed for each determination. The precision of the balance used was 0.0001 grams, indicating a high level of accuracy in measuring the sample.

**Multiple Determinations:** For each sample, three separate determinations were made. This helps ensure the accuracy and reliability of the moisture content measurement by reducing the potential for errors or variations in the results.

**Drying Process:** The samples were introduced into a furnace and subjected to a temperature of 105°C. This temperature is used to evaporate and remove moisture from the samples. The samples were heated until a constant mass was achieved, indicating that all moisture had been removed.

### **Ash content determination**

The operations are part of the process for determining the ash content of a sample according to standard EN ISO 18122. Here's a breakdown of the steps involved:

**Preparation of Crucibles:** Before introducing the samples into the furnace, the crucibles are subjected to a high temperature. They are placed inside the furnace at 550°C for approximately

2 hours. Once the crucibles are cooled, they are weighed, and a minimum of 1 gram of the material to be tested is weighed into each crucible. The precision of the balance used for weighing is 0.0001 grams, ensuring accurate measurements.

### **Ash Content Determination**

Step 1: The crucibles with the weighed samples are introduced into the furnace and heated to at least 250°C for a minimum of 1 hour. This initial step is designed to eliminate volatile matter from the sample before ignition. The temperature is gradually increased to 250°C over a period of 30 to 50 minutes.

Step 2: After the initial step, the temperature inside the furnace is further raised to 550°C, and the samples are maintained at this temperature for a minimum of two hours. This step involves the complete ignition of the sample, leaving behind the ash content. The ash content is corrected to a dry basis by using the moisture content. This correction accounts for the moisture content in the sample and provides a more accurate representation of the ash content on a dry basis.

### **Calorific value determination**

The operations are part of the process for determining the calorific value of samples according to standard EN 14918. The preparation involves using a hydraulic press to create a small pellet-like structure weighing between 0.3 to 0.5 grams. This pellet is then inserted into the calorimetric bomb. The calorimetric bomb containing the sample pellet is introduced into a calorimeter, in this case, Model IKA C 6000. The choice of calorimeter depends on the expected heating value of the sample, which should fall within the calibrated range of the specific calorimeter being used. The data obtained during the calorimeter's operation, including the heat released during combustion, is used to calculate the calorific value of the sample. This value is introduced into the corresponding protocol for obtaining the calorific value.

### **Ion chromatography**

The operations you described involve chromatographic analysis, particularly ion chromatography, which is commonly used for liquid analysis, especially in the determination of various ions in a sample. Ion chromatography is performed using a specific chromatography apparatus, in this case, a Metrohm 930 model. This instrument is equipped with calibration capabilities for various ions, including fluoride, chloride, nitrites, nitrates, bromides, sulfates, and phosphates. Each ion typically requires its own calibration and analytical method. The samples to be analyzed are introduced into the chromatography system, often in vessels with a volume of approximately 10 ml. The chromatography process separates the ions in the sample based on their chemical properties, and the results are presented as peaks on a chromatogram.

### **Carbon, Hydrogen and Nitrogen determinations**

The operations involve a specific analytical method for the determination of certain elements, likely carbon, hydrogen, and nitrogen (CHN), and are performed in accordance with the standard EN ISO 16948. Before performing the analysis on the actual samples, a system check is conducted. This check involves running "blank" tests to ensure that the equipment is properly cleaned and calibrated. Reference materials are also used to calibrate the equipment. These preliminary checks help ensure the accuracy and reliability of the analysis. The results obtained from the system check are used for recalculating the results of the actual samples. This recalibration may be necessary to account for any variations or drift in the equipment's

performance.

### **Determination of ash melting behavior - CEN/TS 15370 - Determination of ash melting behavior**

The operations involve the use of a thermal microscope, specifically the model IRF 1600 F, for the determination of certain material properties at various temperatures. The ashing process begins at a relatively low temperature of 200°C, where the sample is degassed for approximately 20 hours. After this initial degassing, the temperature is gradually increased, first to 250°C for 1 hour and then from 250°C to 300°C over the course of an additional hour. Subsequently, the temperature is raised further, reaching 550°C over a period of 6 hours. A portion of the obtained ash is mixed with ethanol to create a mixture. This mixture is then used to prepare a small pellet. The pellet is introduced into the thermal microscope (model IRF 1600 F) and is allowed to remain inside for a duration of three hours. During this time, the thermal microscope monitors the material as it undergoes various temperature-induced changes. While the sample is inside the thermal microscope, various material properties are observed and recorded. The key points of interest include: shrinking point - The temperature at which the material begins to shrink or undergo dimensional changes; deformation point - The temperature at which the material starts to deform or change shape; hemisphere point - The temperature at which the material exhibits properties resembling a hemisphere; flow point - The temperature at which the material begins to flow or change its physical state.

## **RESULTS AND DISCUSSION**

The studied materials for this paper, consist in silage sorghum from Banat Region (entire plant), Pondalgae from Ghilad area (entire plant) and Reed (entire plant) from Danube area. In Figure 1 are presented samples of material after preparation for ash melting behaviour, for visual purposes.



**Fig. 1.** Ash melting behaviour preparation

The preparation was made by ashing the materials for 14-18 hours at 550 °C. The main purpose of the initial research was to study the general properties of materials in order to determine their initial energetic potential and the presence or absence of heavy metals determined according to standard ISO 17294-2:2016).

In Tables 1 - 4, are presented the general values obtained after laboratory determinations.

**Table 1. Material properties (part 1)**

No.	MATERIAL	Moisture content [%]	Ash content (db) [%]	Gross calorific value (db) [MJ/kg]	Net calorific value (db) [MJ/kg]
1.	Silage Sorgum	5.8	13.9	17.1	15.8
2.	Pond algae	8.7	33.5	14.5	13.3
3.	Reed	6.9	7.3	17.5	16.1

db – dry basis

From Table 1, it can be observed that the pond algae have a great concentration in ash, resulting in high residual material if considering the possibility of using them in firing processes, while the calorific value is high, but still at a lower value than the silage sorgum or reed material.

**Table 2. Material properties (part 2)**

No	MATERIAL	C (db) [%]	H (db) [%]	N (db) [%]	S (db) [%]	Cl (db) [%]
1.	Silage Sorgum	44.5	5.28	2.84	0.204	0.533
2.	Pond algae	37.3	4.48	4.62	0.859	0.102
3.	Reed	45.7	5.50	0.48	0.157	0.270

db – dry basis

In Table 2 is presented most of the elemental composition of the analyzed materials. It was determined that pond algae had the highest sulphur content, while the silage sorgum had the highest chlorine content, both of them having the potential of producing acidic vapors during firing processes.

**Table 3. Material properties (part 3)**

No	MATERIAL	Shrinking temp. [°C]	Deformation temp. [°C]	Hemisp here temp. [°C]	Flow temp. [°C]
1.	Silage Sorgum	750	900	1190	1210
2.	Pond algae	810	1150	1180	1190
3.	Reed	1050	1420	1540	>1550

From Table 3, one can determine that the Reed material has the highest flowing temperature, being out of the range of the used equipment, and also presented the highest points for all the specific temperatures, by comparison with the rest of the analyzed materials.

**Table 4. Material properties (part 4)**

No	MATERIAL	Cd [mg/kg]	Pb [mg/kg]	Cr [mg/kg]	Ni [mg/kg]	As [mg/kg]	Hg [mg/kg]	Zn [mg/kg]	Cu [mg/kg]
1.	Silage Sorghum	0.46	<0.5	1.9	2.5	<0.5	0.102	61	13
2.	Pond algae	1.2	34	32	21	9.4	0.379	3140	1124
3.	Reed	<0.1	<0.5	1.9	1	<0.5	0.075	10	1.8

In Table 4 are presented the general data for the minor elements (heavy metals) for the analyzed materials. In this context, the Pond algae presented the highest values by far, for all the minor elements, in comparison with the other two materials.

## CONCLUSIONS

The present paper represents an initial material study in terms of general physical and chemical properties for three materials, in order to determine their energetic potential and potential applicability for firing processes.

From the gathered data, it results that the pond algae are not a suitable material for combustion in terms of some general characteristics (ash concentration, sulphur content), even if it has a relative high calorific value, while the content of heavy metals is high in comparison with the rest of tested materials.

Silage sorghum and reed can be suitable materials for combustion processes, but the later one can prove problematic in terms of its flow temperature, while the silage sorghum presents an issue with the high chlorine concentration.

Further determinations are necessary and firing testing would be a next logical step, in order to identify a practical approach to compare the obtained data with experimental firing processes.

## REFERENCES

- [1] Wong, WY., Lim, S., Pang, YL., Shuit, SH., Chen, WH., Lee, KT., Synthesis of renewable heterogeneous acid catalyst from oil palm empty fruit bunch for glycerol-free biodiesel production. *Sci Total Environ.* 727:138534, 2020.
- [2] Bridgwater, AV., Renewable fuels and chemicals by thermal processing of biomass. *Chem Eng J.*;91 pp. 87–102, 2003.
- [3] Kumar, V., Binod, P., Sindhu, R., Gnansounou, E., Ahluwalia, V., Bioconversion of pentose sugars to value added chemicals and fuels: recent trends, challenges and possibilities. *Bioresour Technol.* 269 pp. 443–51, 2018.
- [4] Lin, C-Y., Huang, T-H., Cost-benefit evaluation of using biodiesel as an alternative fuel for fishing boats in Taiwan. *Mar Policy.* 36 pp. 103–7, 2012.
- [5] Ning et al., Recent advances in the valorization of plant biomass, *Biotechnol Biofuels* 14:102, 2021.

- [6] Batog, J., Wawro, A., Gieparda, W., Bujnowicz, K., Foksowicz-Flaczyk, J., Rojewski, S., Chudy, M., Praczyk, M., Effective Use of Flax Biomass in Biorefining Processes. *Appl. Sci.*, 13, 7359, 2023
- [7] Pandey, R., Fiber extraction from dual-purpose flax. *J. Nat. Fibers*, 13, 565–577, 2016 [CrossRef]
- [8] FAOSTAT. Available online: <http://www.fao.org> (accessed on 25 Aug 2023)
- [9] Pavelek, M., Tejklova, E., Horacek, J., Flax national collection, international flax data base and breeding of flax, linseed and both types in the Czech Republic. *Nat. Fibres Spec. Ed. Proc. Conf. BastPlants New Millenium*, 1, pp. 64–79, 2001.
- [10] Pavelek, M., Vrobova-Prokopova, M., Ondrackova, E., Ludvikova, M., Griga, M., Developments in fibrous flax and linseed breeding and cultivation. In *Handbook of Natural Fibres*, 2nd ed.; Elsevier: Amsterdam, The Netherlands; Volume 19, pp. 1–95, 2020,
- [11] Booth, I., Harwood, R., Wyatt, J., Grishanov, S., A comparative study of the characteristics of fibre-flax (*Linum usitatissimum* L.). *Ind. Crop. Prod.*, 20, pp. 89–95, 2004. [CrossRef]
- [12] Allen, MS., Coors, JG., Roth, GW., Corn silage. In: *Silage Science and Technology. Agronomy Monograph 42* (Eds Buxton DR, Muck RE, Harrison JH), Amer Soc Agronomy, Crop Sci Soc America, Soil Sci Soc America, Madison, WI, pp. 547–608, 2003.
- [13] Bolsen, KK., Moore, KJ, Coblenz, WK., Siefers, MK., White, JS., Sorghum silage. In: *Silage Science and Technology. Agronomy Monograph 42* (Eds Buxton DR, Muck RE, Harrison JH), Amer Soc Agronomy, Crop Sci Soc America, Soil Sci Soc Amer, Madison, WI, pp. 609–632, 2003.
- [14] Woolford MK The detrimental effects of air in silage. *J Appl Bacteriol* 68: pp. 101–116, 1990.
- [15] Tredici, M.R., Photobiology of microalgae mass cultures: understanding the tools for the next green revolution, *Future science* 1 pp. 143–162, 2010.
- [16] Chen, M., Tang, H., Ma, H., Holland, T.C., Ng, K.Y.S., Salley, S.O., Effect of nutrients on growth and lipid accumulation in the green algae *Dunaliella tertiolecta*, *Bioresource Technology* 102 pp. 1649–1655, 2011.
- [17] Das, P., Lei, W., Aziz, S.S., Obbarda, J.P., Enhanced algae growth in both phototrophic and mixotrophic culture under blue light, *Bioresource Technology* 102 pp. 3883–3887, 2011.
- [18] Feng, P., Deng, Z., Hu, Z., Fan, L., Lipid accumulation and growth of *Chlorella zofingiensis* in flat plate photobioreactors outdoors, *Bioresource Technology* 102 pp. 10577–10584, 2011.





## THE CLIMATE-FRIENDLY CAR DEALERSHIP

**Momir Tabakovic<sup>1</sup>, Mihajlo Keseric**

<sup>1</sup>University of Applied Sciences Technikum Wien, Vienna, Austria

e-mail: [nomir.tabakovic@technikum-wien.at](mailto:nomir.tabakovic@technikum-wien.at)

**Abstract:** Due to the growing demand for energy and the associated emission of greenhouse gases, climate change has become the greatest challenge of our time. To counteract this, it is necessary to reduce greenhouse gas emissions. The building stock, which causes more than one-third of the greenhouse gas emissions in the European Union, can contribute to this. This will be investigated in this thesis. Specifically, it is about identifying measures by which car dealerships can manage to reduce their greenhouse gas emissions and achieve climate neutrality.

These investigations were carried out based on a real car dealership. To this end, a literature review about refurbishment and energy efficiency was first conducted. Then, the dealership was examined on-site to identify the measures. The effects of the measures on the energy demand and greenhouse gas emissions of the building were calculated. This was also done for the existing car dealership in Austria. In the last step, it was verified whether both the investigated car dealership and the Austrian inventory could achieve climate neutrality

In addition to the numerous measures found, the two with the greatest effect on the energy requirements of the car dealership are the use of photovoltaics and the renovation of the building envelope, whereby the use of photovoltaics was half the cost of renovating the building envelope. In comparison, the use of air-drying paints reduced greenhouse gas emissions the most. Social measures can also further reduce greenhouse gas emissions.

By implementing the measures, the part of the car dealership investigated in the first step could not achieve climate neutrality. The emissions that continued to be emitted could not be completely compensated by photovoltaics. However, if the field of observation is extended to the entire car dealership, it is possible to cover the open spaces with photovoltaics and to compensate for the greenhouse gases that continue to be emitted.

When considering the Austrian car dealership stock, the use of photovoltaics was identified as the measure with the greatest effect on energy demand. This is also the case for greenhouse gas emissions. By implementing the measures, the Austrian car dealership stock was able to achieve climate neutrality and contribute 1.67% to the climate targets.

In conclusion, the available area for the use of photovoltaics is one of the key factors in achieving climate neutrality. By implementing the measures, the energy demand can be reduced, but not completely, which makes compensation necessary.

**Key words:** Energetic-thermal renovation, car dealership, trade, guideline, climate neutrality

### INTRODUCTION

In recent years, the issue of climate change has increasingly come into focus. The reason for this is the growing demand for energy and the associated emission of greenhouse gases, among other things through the burning of fossil fuels, which has led to an exacerbation of the climate problem. Instead of just climate change, we now speak of a climate crisis.

This crisis has also been recognized and addressed by the European Union. Climate neutrality by 2050 was set as a goal. To achieve this, the "Fit for 55" package was enacted, which aims to achieve a 55% reduction in net greenhouse gas emissions compared to 1990 levels. This is to be implemented by 2030. In addition to the use of emissions trading systems, alternative fuels, energy taxation and the transition to a renewable energy system, the refurbishment of the building stock is one of the most important topics of this package.

The building stock, which causes more than one-third of the greenhouse gas emissions in the European Union, is to become more energy efficient and climate neutral by 2050 through renovation and other measures, [1].

This crisis has also been recognized and addressed by the European Union. Climate neutrality by 2050 was set as a goal. To achieve this, the "Fit for 55" package was enacted, which aims to achieve a 55% reduction in net greenhouse gas emissions compared to 1990 levels. This is to be implemented by 2030. In addition to the use of emissions trading systems, alternative fuels, energy taxation and the transition to a renewable energy system, the refurbishment of the building stock is one of the most important topics of this package. The building stock, which causes more than 1/3 of the greenhouse gas emissions in the European Union, is to become more energy efficient and climate neutral by 2050 through renovation and other measures, [1]. The Austrian government, on the other hand, is much more ambitious. It wants to achieve climate neutrality as early as 2040, [2]. To achieve this goal, the photovoltaic offensive, which is intended to promote the expansion of renewable energies, and the renovation offensive were launched. The latter is intended to promote the renovation of buildings. The renovation offensive promotes the renovation of single and multi-apartment buildings as well as commercial buildings [3]. This area offers great savings potential, both in ecological and economic terms.

This master thesis deals with the identification of measures to achieve climate neutrality in a commercial enterprise. Due to the different uses of space such as workshops, showrooms, offices or social rooms within a car dealership, the energy demand can be high. Car dealerships therefore offer t potential, but at the same time they are also a challenge. However, this does not mean that the goal of a climate-friendly car dealership has been achieved. In addition to the technical potential, the social aspects must also be considered to achieve the set goal.

Since car dealerships currently have a bad image because they sell one of the biggest polluters, cars, this work aims to show that it is nevertheless possible to contribute to climate neutrality.

## **MATERIAL AND METHODS**

To get a picture of the car dealership and to search for existing documents, the dealership was visited. Since the documents found were incomplete, an on-site analysis was imperative. The existing plans were viewed and compared with the current state of the building. During the site visit, potential improvements were sought. The thermal and electrical energy demand was determined by annual billing. Natural gas demand was determined in the same way. The electrical power demand was determined with power meters.

### **Calculation of the effect of the measures on Austria's national climate targets**

The effect of the dealership on Austria's national climate targets was calculated using Microsoft Excel. The emission factors, used in the calculation of the effect on Austria's national climate target, come from the Austrian Federal Environment Agency and are crucial for calculating the CO<sub>2</sub> equivalent of the amount of energy saved, [4]. Each energy source has different emission factors that are considered.

Step 1 considers each measure separately for one part of the dealership. The amount of energy saved is multiplied by the emission factor to determine the CO<sub>2</sub> equivalent saved. This is then compared to the national targets to determine the contribution of the measure.

Step 2 considers the implementation of all measures throughout the whole dealership. The order was determined to prioritize the measure with the greatest savings. The calculation of the total effect is the same as in step 1.

These steps are also applied to the entire car dealership inventory in Austria, which needs renovation. Here, the inventory was determined by internet research, and the construction period was determined based on new vehicle registrations, [5, 6].

## Definition of climate neutrality in the commercial sector

The work from Christensen et al. was used to define climate neutrality for this work. According to this work climate neutrality is achieved when the greenhouse gases emitted are reduced and subsequently the remaining ones are offset. It should also be noted that, according to this definition, only emissions generated within the company are considered. In relation to the industry under consideration, the greenhouse gas emissions from vehicle production and test drives do not fall on the industry. Thus, climate neutrality in this work means reducing greenhouse gas emissions and offsetting the remaining emissions, [7].

## Definition of the Austrian climate targets

As already described in the introduction, Austria has set itself the goal of climate neutrality by 2040. To achieve this goal, target values have been defined in the Climate Protection Act. According to this law, greenhouse gas emissions in sectors outside the EU emissions trading system are to be reduced by 36% compared to 2005. These sectors are buildings, road transport, waste, and agriculture. The considered car dealership belongs to the commercial sector, which is part of the building sector. However, the target set was raised by the "Fit for 55" package. It was enacted because the European Union recognized that the initially set target was not compatible with climate neutrality by 2050. The "Fit for 55" package resulted in the national target increasing from a 36% reduction to a 48% reduction. As this package was presented after 2018, it does not make sense in this paper to refer to the Climate and Energy Strategy published in 2018. This has not been updated as of 05.2023. For this reason, the targets are calculated using the greenhouse gas emissions from 2005, [8].

According to the measurements of the Federal Environment Agency, greenhouse gas emissions in 2005 amounted to 56.3 million tons of CO<sub>2</sub> equivalent, [9]. To achieve the targets, set by the government and the European Union respectively, this must be reduced by 48%. The target value to be achieved is 29.276 million tons of CO<sub>2</sub> equivalent. A saving of 27.024 million tons of CO<sub>2</sub> equivalent must be achieved.

## RESULTS AND DISCUSSION

Part of the car dealership examined in the first step					
Measures	Energy demand before the measures	Energy saving	GHG reduction	Participation in the Austrian climate targets	Kosteneinsatz
-	[kWh/a]	[kWh/a] / [m <sup>2</sup> /a]	[kg] CO <sub>2</sub> equivalent	[%]	[€]
thermal measures	164 143,00	131 494,96	25 115,54	0,0000929%	470 688
electrotechnical measures	138 474,39	84 195,62	17 007,52	0,0000629%	185 358
Compensation of the Austrian electricity mix	-	76 850,79	15 523,86	0,0000574%	-
air drying paint shop	288 420,00	26 460,55	71 919,77	0,0002661%	26 500
Employee public transport	-	-	215,75	0,0000008%	1 095
Employee 50% public transport / 50% bicycle	-	-	107,88	0,0000004%	1 095

**Fig. 1.** Participation of the part of the car dealership examined in the first step after the implementation of all measures to the national goals

In Figure 1 the participation of the part of the car dealership examined in the first step after the implementation of all measures to the national goals is shown. Since the measures influence each other, a total reduction was calculated for each form of energy used. In doing so, the measures were prioritized according to their participation in the targets. Taking the thermal measures as an example, the building envelope would be refurbished first, then a ventilation unit with heat recovery would be installed, then the door air curtain would be installed, and new pipe insulation would be installed. To contribute as much as possible to the climate goals, the paint shop was converted, which is why the exhaust air can no longer be used. The

electrotechnical measures were identified in the same way. The two measures for reducing trips were presented separately.

The thermal and electrotechnical measures achieve an almost equal contribution to the climate targets. However, this is only true without considering the compensation of the electricity mix by photovoltaics. The compensation was presented separately to show its effect. The electrotechnical measures contribute more than the thermal ones and are also cheaper.

Furthermore, both thermal and electrotechnical measures approach the effectiveness of the paint shop in participation in the climate goals, nor in cost efficiency. It can be concluded that the use of air-drying paints should be the priority. This is followed by electrotechnical measures and, finally, thermal measures. In the case of the electrotechnical measures, the use of photovoltaics should be prioritized. For the thermal measures, the renovation of the building envelope should be prioritized.

whole car dealership					
Measures	Energy demand before the measures	Energy saving	GHG reduction	Participation in the Austrian climate targets	Cost
-	[kWh/a]	[kWh/a] / [m <sup>2</sup> /a]	[kg] CO2 equivalent	[%]	[€]
Thermal measures	410 358	328 737	62 789	0,0002323%	1 176 721
Electrotechnical measures	492 707	299 577	60 515	0,0002239%	720 983
Compensation of the Austrian electricity mix	-	290 224	58 625	0,0002169%	-
Air drying paint shop	288 420	26 461	71 920	0,0002661%	26 500
Employee public transport	-	-	216	0,0000008%	1 095
Employee 50% public transport / 50% bicycle	-	-	108	0,0000004%	1 095

**Fig. 2.** Participation of the whole car dealership after the implementation of all measures to the national goals

In Figure 2 the participation of the whole car dealership after the implementation of all measures to the national goals is shown. If we compare Figure 1 and Figure 2 with each other, we can see that the participation of thermal and electrotechnical measures has increased. This is due to the increased energy demand since the entire car dealership is now considered. The participation of these two measures increased but does not come close to the participation of the paint shop. Neither in terms of cost efficiency nor in terms of participation. This is only true if the displacement effect of photovoltaics is not considered. If this is considered, the electrotechnical measures would be the best option in terms of participation in the Austrian climate targets. If all the measures found were implemented, the car dealership in question could contribute 0.0004806% to the climate targets. This would require an investment of 684 737 €.

Car dealership stock in need of renovation					
Measures	Energy demand before the measures	Reduction due to the measure	GHG reduction	Participation in the Austrian climate targets	Cost
-	[kWh/a]	[%]	[kg] CO2 equivalent	[%]	[€]
Thermal renovation measures for district heating system	28 363 910	80%	4 339 965	0,0161%	32 533 986
Thermal renovation measures for heating oil system	283 639 104	80%	74 994 179	0,2775%	325 339 857
Thermal renovation measures for natural gas heating system	177 274 440	80%	35 363 811	0,1309%	203 337 410
Thermal renovation measures for liquid gas heating system	7 090 978	80%	1 863 297	0,0069%	8 133 496
Thermal measures for biomass heating system	14 181 955	80%	307 276	0,0011%	16 266 993
Switch from fuel oil to heat pump	45 382 257	100%	14 998 836	0,0555%	51 424 358
Switch from fuel oil to district heating	11 345 564	100%	3 533 009	0,0131%	829 440
Switch from natural gas to heat pump	28 363 910	100%	7 072 762	0,0262%	32 140 224
Switch from natural gas to district heating	7 090 978	100%	1 643 936	0,0061%	518 400
Switch from liquid gas to heat pump	283 639	100%	93 165	0,0003%	1 157 048
Electrotechnical measures	851 397 091	69%	118 414 893	0,4382%	622 929 226
Compensation of the electricity mix by photovoltaics	-	-	101 304 369	0,3749%	-
Air drying paint shop	31 752 660	100%	86 303 730	0,3194%	31 800 000
Employee public transport	-	-	1 035 600	0,0038%	5 256 000
Employee 50% public transport / 50% bicycle	-	-	517 824	0,0019%	5 256 000
Total			451 786 651	1,67%	1 336 922 438

**Fig. 3.** Participation of the car dealership stock in need of rehabilitation in the implementation of all measures to the national goals

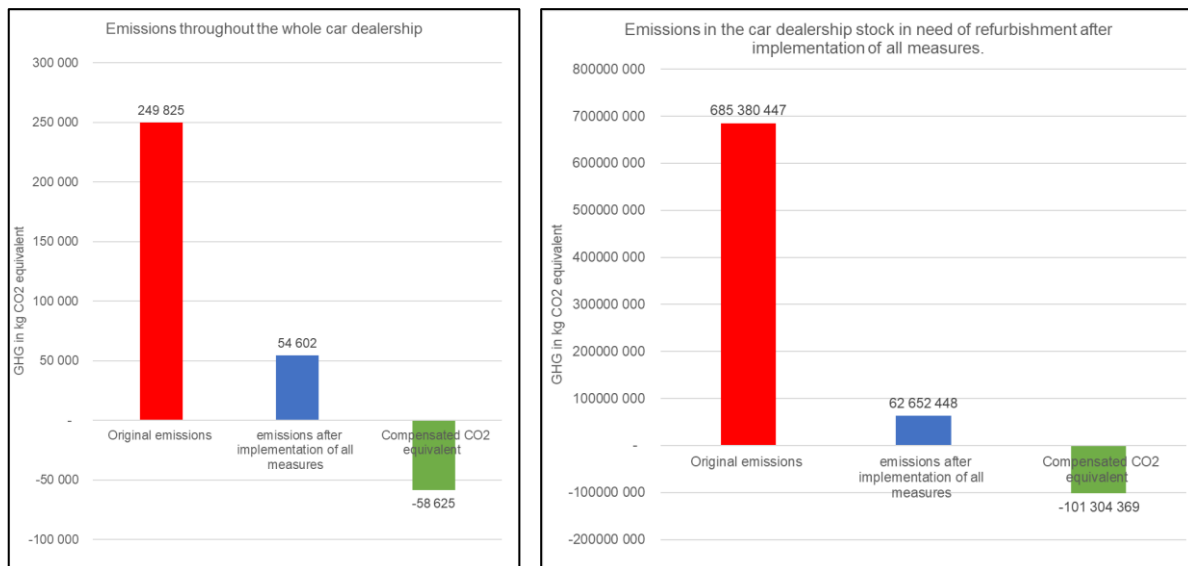
Figure 3 shows the participation of the car dealership stock in need of refurbishment in the national targets if all measures are implemented. The same values were assumed for the effectiveness of the thermal measures as for the dealership. The effectiveness of the electrotechnical measures (lighting and compressed air, remaining effectiveness unchanged) was adjusted to the values of the industry folder, [10]. This increase in effectiveness was applied because the inspected car dealership already adjusted most of the lighting and the compressed air system showed almost no loss. The losses of the compressed air system are widespread, as shown in the folder.

In the figure, 1.67 % of the savings target, which is 451 786 651 kg CO<sub>2</sub>-equivalent, can be achieved by implementing all measures on the car dealership stock. This will require 1.336 billion €. The largest contribution to the climate targets is made by the electrical measures with 0.4382 % and costs of 622 million €. The thermal measures account for 0.4325 %. The implementation of these would require an investment of 585 million €. To this must be added the effect of the replacement of the heating system, which was carried out for fuel oil, natural gas, and liquid gas. This would account for 0.1012 %. This results in a total contribution of 0.5336 %. The replacement of the heating system takes place after or during the

implementation of the thermal measures to keep the investment costs low, due to the reduced output. It was assumed that 80% of the companies do not have access to district heating and therefore rely on a heat pump. The remaining 20% have access and use it. Users of liquid gas all rely on a heat pump. However, electrical energy is required to operate the heat pumps, which was considered in the calculation in Figure 3.

This results in a necessary total investment in all thermal measures of 671 million €. The electrical measures including the compensation of the electricity mix by photovoltaics account for 0.8131 % and investment costs of 622 million €. The third best measure identified was the use of air-drying paints. This can achieve a contribution of 0.3194 %. This would cost 31 million €. Compared to the examined car dealership, the participation in the climate targets has changed. It can be said that considered over all car dealerships, the thermal and electrotechnical measures have a higher participation than the paint shop. Considered at one dealership, the paint shop has the highest participation.

The last two measures, in which employees adapt their mobility behavior, contribute 0.0057 % to achieving the climate targets. It was assumed that two employees each would be persuaded to use their own vehicles and use public transport and bicycles. The cost of these measures amounts to 10.512 million €. This measure was applied to all car dealerships, as it cannot only be applied to the stock in need of renovation.



**Fig. 4** Emission balance of the of the analyzed car dealership (left) and the car dealership stock in need of refurbishment (right)

Figure 4 shows the emission balance of the analyzed car dealership (left) and the car dealership stock in need of refurbishment (right). The red bar represents the emissions that will be emitted before all measures are implemented. The blue bar shows the emissions that were emitted after the implementation of all measures, as these cannot be completely prevented. To achieve climate neutrality the emissions can be compensated. This compensation is achieved by displacement of the electricity mix and is represented by the green bar. If we now compare the blue and green bars, we will see that the green bar is higher. Thus, it can be said that the analyzed car dealership and the car dealership stock in need of refurbishment could achieve climate neutrality by implementing the measures.

## CONCLUSION

The measures found prioritized according to the climate targets are:

- the use of air-drying paints or waste heat recovery in the paint shop

- the use of photovoltaics and energy storage systems or the compensation of the electricity mix
- renovation of the building envelope
- the installation of a ventilation system with heat recovery
- the use of door air curtains in the workshop
- replacement of the heating insulation
- training and sensitization of employees
- the replacement of the lighting
- the renewal of the compressed air system
- adjustment of the lighting time
- the replacement of the pumps used in the heating system

Other measures whose effect has not been determined.

- implementation of a building management system
- replacement of electrical installations and heating fittings
- the creation of a renewable energy community
- the use of green spaces
- the use of a building management system

By implementing these measures, the dealership under study was able to save 628 314 kWh of energy and 26 460,55 m<sup>3</sup> of natural gas. This amount of energy corresponds to 254 172 kg of CO<sub>2</sub> equivalent, which means that the set goal of a climate-friendly car dealership was achieved. The participation in the climate targets was 0.0009405 %.

The operational influences were determined in the same way. To achieve climate neutrality and this participation, the car dealership must invest 1 926 394 €.

In the further course of the work, the building stock in need of renovation was surveyed and a reference building was modeled from it. The energy sources used in this building stock were also determined to determine the participation in the national climate targets. The result was that the participation is 1,67%, which corresponds to a reduction in greenhouse gas emissions of 451 786 651 kg CO<sub>2</sub> equivalent. To achieve this participation, investment costs of 1,336 billion € are incurred.

In the last step of the work, it was checked whether the building stock in need of renovation would also achieve climate neutrality. Climate neutrality could also be achieved there through the measures found.

In the sense of research, the actual, current building stock and the heat supply systems used should be surveyed to make the results found by this work comparable. Finally, the transferability of the results to similar areas such as furniture stores should be investigated.

## REFERENCES

- [1] European Union, „Fit for 55: making buildings in the EU greener“, Available at <https://www.consilium.europa.eu/en/infographics/fit-for-55-making-buildings-in-the-eu-greener/>
- [2] Bundesministerium für Klimaschutz, Umwelt, Energie, Mobilität, Innovation und Technologie, „Die österreichische Klimaschutzstrategie/Politik“, Available at [https://www.oesterreich.gv.at/themen/bauen\\_wohnen\\_und\\_umwelt/klimaschutz/1/Seite.1000310.html](https://www.oesterreich.gv.at/themen/bauen_wohnen_und_umwelt/klimaschutz/1/Seite.1000310.html)
- [3] Bundesministerium für Klimaschutz, Umwelt, Energie, Mobilität, Innovation und Technologie, „Sanierungsinitiative 2023/2024“, Available at [https://www.oesterreich.gv.at/themen/bauen\\_wohnen\\_und\\_umwelt/energie\\_sparen/1/sanierungsinitiative.html](https://www.oesterreich.gv.at/themen/bauen_wohnen_und_umwelt/energie_sparen/1/sanierungsinitiative.html)



- [4] T. Loessl, „Emissionskennzahlen 2022“, Available at [https://www.umweltbundesamt.at/fileadmin/site/themen/mobilitaet/daten/ekz\\_pkm\\_tkm\\_verkehrsmittel.pdf](https://www.umweltbundesamt.at/fileadmin/site/themen/mobilitaet/daten/ekz_pkm_tkm_verkehrsmittel.pdf)
- [5] ÖGVS – Gesellschaft für Verbraucherstudien mbH, „Autohandel in Österreich: Qualität bleibt wichtig“, Available at <https://www.qualitaetstest.at/consumer-infos/autohandel-in-oesterreich-qualitaet-bleibt-wichtig/>
- [6] Wirtschaftskammer Österreich, „Österreichs Außenhandel“, Available at <http://wko.at/statistik/Extranet/Langzeit/Lang-Kfz.pdf>
- [7] J. Christensen, J. Kessler, M. Krey, und M. André Marr, „ANALYSE Klimaneutralität von Unternehmen Bestehende Standards, Initiativen und Label sowie Einordnung der Rolle von Treibhausgas-Kompensation“, Available at [https://www.dena.de/fileadmin/dena/Publikationen/PDFs/2022/ANALYSE\\_Klimaneutralitaet\\_von\\_Unternehmen.pdf](https://www.dena.de/fileadmin/dena/Publikationen/PDFs/2022/ANALYSE_Klimaneutralitaet_von_Unternehmen.pdf)
- [8] Bundesministerium für Klimaschutz, Umwelt, Energie, Mobilität, Innovation und Technologie, „Die österreichische Klimaschutzstrategie/Politik“, Available at [https://www.oesterreich.gv.at/themen/bauen\\_wohnen\\_und\\_umwelt/klimaschutz/1/Seite.1000310.html](https://www.oesterreich.gv.at/themen/bauen_wohnen_und_umwelt/klimaschutz/1/Seite.1000310.html)
- [9] Umweltbundesamt, „Treibhausgas-Bilanz Österreichs 2019“, Available at <https://www.umweltbundesamt.at/news210119>
- [10] Energieinstitut der Wirtschaft GmbH, „ENERGIEEFFIZIENTER KFZ-BETRIEB“, Available at [https://www.klimaaktiv.at/dam/jcr:0884946a-44c6-44f5-8183-d8b6001138cd/KMU\\_Scheckauswertung%20produzierende%20Betriebe.pdf](https://www.klimaaktiv.at/dam/jcr:0884946a-44c6-44f5-8183-d8b6001138cd/KMU_Scheckauswertung%20produzierende%20Betriebe.pdf)



## RELIABILITY OF THE BIOGAS PLANT

Jovana Radnović<sup>1</sup>, Ljiljana Radovanović<sup>1</sup>, Marko Ristić<sup>2</sup>, Borivoj Novaković<sup>1</sup>

<sup>1</sup>University of Novi Sad, Technical Faculty "Mihajlo Pupin", Zrenjanin, Serbia

<sup>2</sup>University of Belgrade, Institute Mihajlo Pupin, Volgina 15, Belgrade, Serbia

e-mail: [jovana.radnovic@tfzr.uns.ac.rs](mailto:jovana.radnovic@tfzr.uns.ac.rs)

**Abstract:** With the development of technology in the modern world, the need for energy is growing. Modern society strives to simultaneously preserve the environment and provide a sufficient amount of energy. In order to meet the energy demand, completely new guidelines are being set for the fuels and technologies that will be used in the future. Biogas technology is becoming increasingly applicable worldwide, especially in countries where governments are promoting domestic biogas systems. In order to analyze the current and future flexibility needs of the biogas system, the fault tree analysis method is used. The method is based on fault trees generated for each system load point. This research applies a fault tree approach to identify failures and evaluate their effects on the operation of biogas systems from a technical point of view, based on five defined subsystems, including structural components, biogas utilization equipment, piping system, biogas production and wastewater disposal system.

**Key words:** biogas plants, risk assessment, safety

### INTRODUCTION

Biogas is obtained by the decomposition of organic matter in anaerobic conditions, where its composition and properties depend on the type of raw material and the technological conditions of the process [1]. Anaerobic digestion (AD) of organic waste is an attractive biotechnology used in engineered anaerobic digesters for the treatment of high-strength industrial and food wastewater until discharge [2] in which microorganisms break down complex organic matter into simpler components under anaerobic conditions for the production of biogas and fertilizers. After the AD process, biogas can be upgraded to biomethane, an attractive renewable energy source alternative to natural gas [3].

Since biogas is produced where organic material is decomposed without air, a wide range of organic matter is suitable for anaerobic digestion. Some of these materials are: liquid and solid manure, specially collected biological waste from residential areas, renewable materials such as corn silage, seeds not used for food, sludge from sewage and grease, used lubricants, grass (eg, in the EU from uncultivated land), biological waste from slaughterhouses; brewery, distillery; fruit processing, wine production; dairy; pulp industry, sugar factory [4]. In principle, how much biogas will be produced in one biogas plant depends on the composition of the substrates used [5].

In the last ten years, biomethane production has tripled. Despite the widespread installation of biomethane plants, the safety of such energy supply has yet to be specifically addressed to date, and there needs to be dedicated safety standards aimed at controlling the hazards and risks associated with the production and improvement of biomethane. Learning from past accidents and raising risk awareness in this nascent energy sector is critical to the scale and sustainability of the exploitation of such a renewable resource [6].

## MATERIAL AND METHODS

### Description of the biogas plant

The technological process of the operation of the biogas plant involves the production of electricity from biogas [7]. The production process itself is a complex process consisting of several stages. The first stage includes feeding the fermenter with liquid and solid substrate. The second stage includes the fermentation process with constant mixing in the fermenter and the extraction of biogas, and the third stage includes the process of electricity production and delivery to the distribution network [8,9]. The operation of the biogas plant itself depends on the substrate mass used, the size of the fermenter, the technological equipment, the method of dosing the substrate, and the fermentation time [10].

The raw biogas produced in the plant undergoes basic cleaning before being used in the CHP unit, as shown in Fig.1. Since raw biogas is a mixture of desirable and undesirable constituents, basic cleaning and fine cleaning are required. Basic cleaning is usually done in a biogas production plant (digester), and fine cleaning or purification in a biogas processing plant [11]. In order to adapt the processed biogas (biomethane) to the quality standards of natural gas pipelines and/or the demands of natural gas consumers (natural gas vehicle, gas burner, CHP unit, etc.), further conditioning (for example, adjustment of methane content and calorific value, etc.) should be performed, depending on national regulations. This treatment is performed in biogas conditioning plants [12]. Before injecting processed biomethane into a specific natural gas network, further steps are required: pressure adjustment, pressure protection, gas meter, and, if necessary, odorization [13].

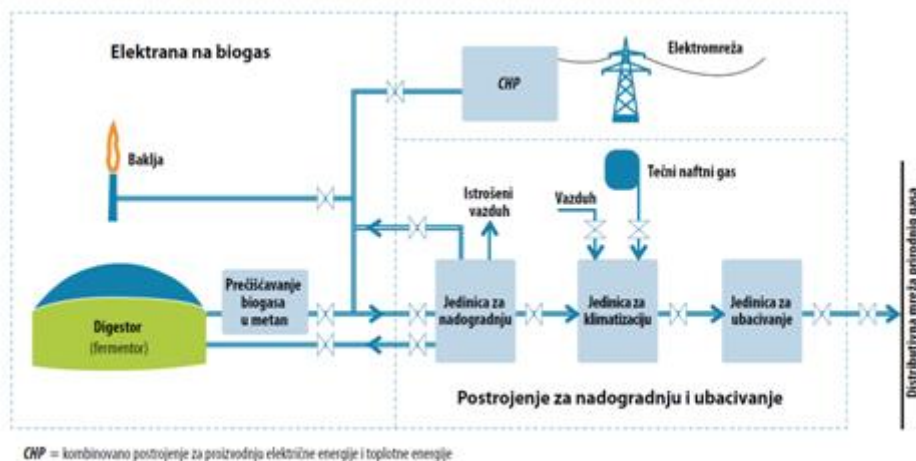


Fig 1. View of the biogas plant

### General methods for risk assessment

Biogas plants are complex process engineering systems in which several different hazards can occur. In order to prevent accidents, hazards in biogas plants must be systematically recognized, evaluated, and minimized. This is the purpose of risk analysis. The tool for performing this analysis is the risk matrix, which shows the degree of probability that an adverse event will occur (risk) associated with the consequences of that event [14].

Risk analysis can be defined in many different ways. The best approach is to divide risk analysis into two components: risk assessment (identifying, assessing, and measuring the likelihood and severity of risk) and risk management (deciding what to do about the risk), (S Wikipedia)

Companies and their employees face a wide and varied panorama of risks. In addition to various commercial risks, several specific types can be listed:

- Occupational injuries and health risks.
- Fires and explosions.
- Damage to machinery and equipment.
- Transport injuries and related damage.
- Product liability and related damages.
- Environmental damage resulting from the organization's activities.
- Sabotage.

But this assumes that the appropriate method is chosen according to the situation, otherwise, the utility will be small and maybe even negative. Using one or more security analysis methods can have the following types of benefits:

The general experience is that far more hazards and ideas for improvements are discovered than traditional security work. Part of the explanation is that security analysis offers a complementary perspective and adds to earlier ways of working and thinking.

1. Several methods are based on solid experiences, which have been put together in a compact format, with checklists, etc. Other ways of obtaining the necessary information would be more time-consuming and difficult.
2. In complex systems, which usually involve several hazards, it is necessary to work systematically, so that important aspects are not overlooked.
3. Security in the system depends on cooperation between people in different positions. Using the security analysis method can provide a good format for teamwork because it offers a step-by-step approach [15].

Many methods of reliability analysis (such as failure cause and effect analysis, failure tree analysis, and importance analysis in terms of the reliability of the entire system) can be successfully applied to determine the safety characteristics of the TEP system (primary and secondary events, peak event, probability of peak events, minimum sets of sections, degree of criticality of failure types and its entirety). The causes of unwanted (harmful) events are stochastic phenomena because they depend on a series of certain but also random factors, the effect of which most often cannot be fully understood. Preventive measures in some way plan the activities of suppression and possible reactions to this group of factors [16]. Cause of failure analysis is used to discover the cause of failure [17,18]. A classic technique is the fault tree analysis (FTA) [19,20]. A fault tree translates a physical system into a logical diagram of the various combinations of possible events. The FTA method was created in the 60s of the twentieth century and is suitable for qualitative or quantitative analysis, and is one of the most used methods for discovering the cause of failure.

### **Failure tree analysis**

Failure tree analysis (FTA) is one of the basic system reliability and safety analysis methods. It was developed in the sixties (1961) at Bell Laboratories, and today, it is widely used in various fields such as chemical processes, electrical and electronic systems, nuclear power plants, quality assurance, etc. FTA is a graphical representation of the state or other factors that influence the creation of an unwanted event.

A fault tree diagram is an excellent way to derive failure logic for a system. It is ideal for communicating with managers, designers, operators, etc. The method was first conceived, and algorithms for deriving minimal cut sets worked directly with the fault tree diagram using a bottom-up approach. It is a top-down analysis, meaning that the analysis is performed from top to bottom, from more complex to simpler elements [21].

A fault tree diagram defines the causes of a system's failure mode or "top event" regarding component failures and human error, represented by underlying events. By providing information that allows the underlying probability of an event to be calculated, the fault tree can then be quantified to obtain system reliability parameters [22].

The fault tree contains three symbols: event symbols, transfer symbols, and logic circuit symbols, such as in Fig. 1.

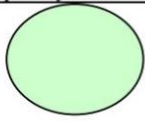



Graphic symbol	Meaning
	<b>Primary events:</b> these events, for one reason or another, are not further investigated; if you want to perform a quantitative analysis to estimate the frequency of occurrence of the top event you need to know the frequency of occurrence of these primary events, for example, estimating it through a historical analysis.
	<b>Intermediate events:</b> these are events that occur before or after another event and represent the cause of the next event; they are connected to the events preceding or following them by gates.
	<b>OR-gate:</b> so that the output of the gate takes place, it is sufficient that one of the inputs to the gate itself (which may be any number greater than 1) occurs.
	<b>AND-gate:</b> so that the output of the gate happens, it is necessary that all the inputs to the gate itself (which may be any number greater than 1) occur.

Fig 2. FTA symbols

### Quantitative and qualitative risk analysis

The quantitative fault tree analysis represents a calculation of the top event probability, equal to the failure probability of the corresponding load. The calculation of the top event probability:

$$Q_{gd} = \sum_{i=1}^n Q_{MCSi} - \sum_{i < j} Q_{MCSi} \cap_{MCSj} + \sum_{i < j < k} Q_{MCSi} \cap_{MCSj} \cap_{MCSk} - \dots + (-1)^{n-1} Q_{\cap_{i=1}^n MCSi} \quad (1)$$

can be simplified and approximated (using rare event approximation) as:

$$Q_{gd} = \sum_{i=1}^n Q_{MCSi} \quad (2)$$

where  $Q_{gd}$  is top event probability of the fault tree, corresponding to probability of disruption of energy delivery to the corresponding load. Probability of each minimal cut set is calculated using the relation of simultaneous occurrence of independent events:

$$Q_{MCSi} = \prod_{j=1}^m Q_{Bj} \quad (3)$$

where  $Q_{MCSi}$  is probability of minimal cut set  $i$ ;  $m$ , number of basic events in minimal cut set;  $Q_{Bj}$ , probability of the basic event  $B_j$  describing failure of the component (i.e. failure probability of component  $B_j$ ).

The fault tree analysis results include importance measures risk achievement worth (RAW) and risk reduction worth (RRW) in addition to the top event probability [23].

Qualitative fault tree analysis defines the structure of functions related to the peak event. Here the tree is examined from the aspect of algebra. In the qualitative analysis of traditional static fault trees, minimum cut sets (MCS) are determined from the structure of the fault tree. MCS represents the minimum combination of events that can cause the largest tree fault event.

### Minimal cut sets and top event quantification

Minimal cut sets (MCS) are one of the critical products of FTA. They identify component failures and combinations of events that can cause the above UE. CS also provides a mechanism for calculating probabilities. CSs reveal critical and weak links in system design by identifying components with security problems, a high probability of CS, and where intended security or redundant features have been bypassed [24]. If no multiple events exist in the SN, all sections are minimal [24].

The conventional approach to obtain the exact probability of the top event is to use the formula:

$$P(\text{Top}) = \sum_{i=1}^{nc} P(C_i) - \sum_{i=2}^{nc} \sum_{j=1}^{i-1} P(C_i \cap C_j) + \dots + \dots (-1)^{nc-1} P(C_1 \cap C_2 \cap \dots \cap C_{nc}) \quad (4)$$

where  $C_i, i=1, \dots, n_c$ , are the minimal cut sets of the top event. Clearly, if the fault tree has many minimal cut sets, calculating  $P(\text{Top})$  will require extensive calculations to evaluate each term in expression (4). For many complex fault trees this processing requirement is beyond the capability of the available machines. In order to reduce the calculations to a practical size, approximations can be used. The rare event approximation  $PRE(\text{Top})$  is commonly used:

$$P_{RE}(\text{Top}) = \sum_{i=1}^{n_c} P(C_i) \quad (5)$$

### Case study risk assessment

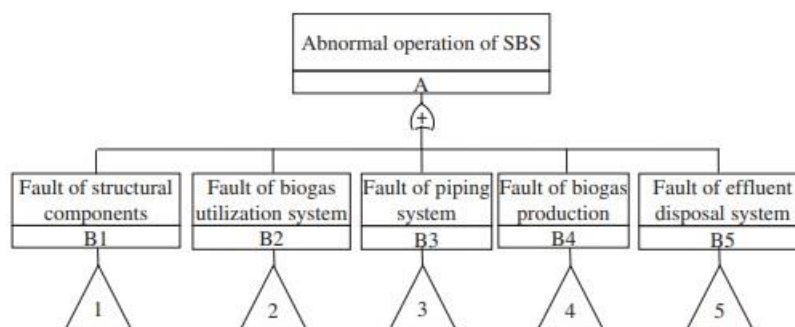
There are problems in biogas technology, such as poor construction, leaking pipelines, low biogas production, and lack of maintenance. These problems should be identified and analyzed for effective implementation and more efficient operation of smaller biogas systems. This research applies a fault tree approach (FTA) to identify faults and evaluate their effects on the operation of biogas systems from a technical point of view.[25]

A typical small-scale biogas plant is usually described as a biogas production and utilization system composed of five main categories:

1. structural components (inlet tank, outlet chamber and digester), pipeline system (gas pipeline and valve),
2. system for using biogas (biogas stove and biogas lamp),
3. waste water disposal system (digestate storage and reuse)
4. piping systems
5. elements related to the process of anaerobic digestion (biogas production).

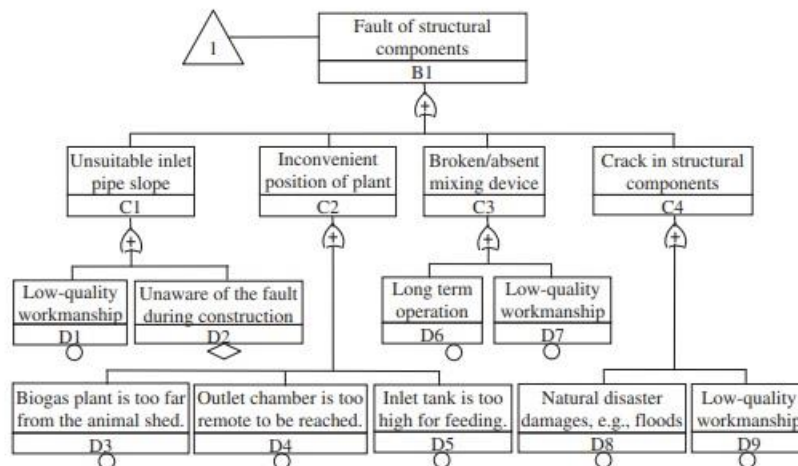
The five categories of biogas systems can be treated as five subsystems. Together, these subsystems cover the entire biogas system. Each subsystem can be reduced to a collection of primary events in a fault tree. Technical problems identified in the field of the study are summarized. Each problem represents an underlying event. Based on the observed problems, the criteria for SST were defined.

Failure of a biogas system occurs due to events occurring in one or more of the five subsystems (structural components, biogas utilization equipment, piping system, biogas production, and effluent disposal system). As such, any failure in the subsystem (called "level one contributors") can lead to an abnormal operating biogas system. Similarly, subsystem failure also results from adverse events in second-level contributors to underlying events [26]. The fault tree's most critical event is the biogas system's abnormal operation. The global system fault tree of a biogas plant Fig. 2 is a gateway that includes the faults of five subsystems: structural components, biogas equipment utilization, piping system, biogas production, and system wastewater disposal. Fig. 3,4,5,6,7 presents five fault trees for subsystems. Each type of failure is decomposed from one cause to another until the underlying events responsible for the unwanted event are obtained [27].

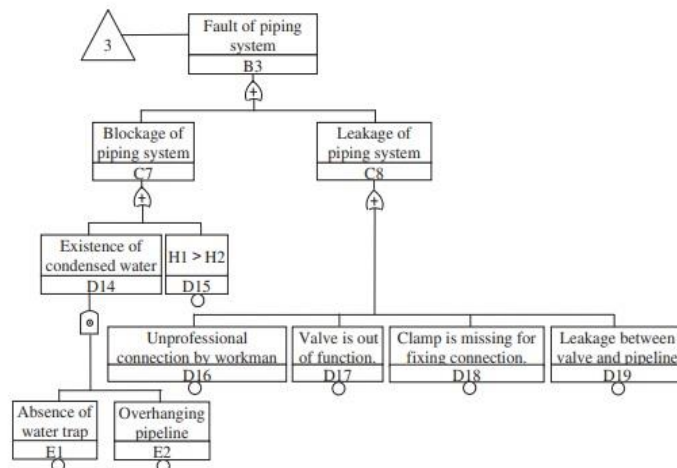


**Fig 3.** Global fault tree of Small Biogas System (SBS)

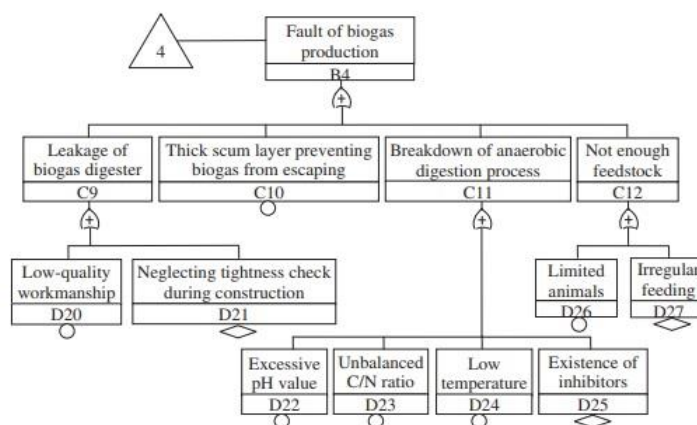




**Fig 4.** Fault tree of biogas utilization systems



**Fig 5.** Fault tree of the piping system



**Fig 6.** Fault tree of biogas production



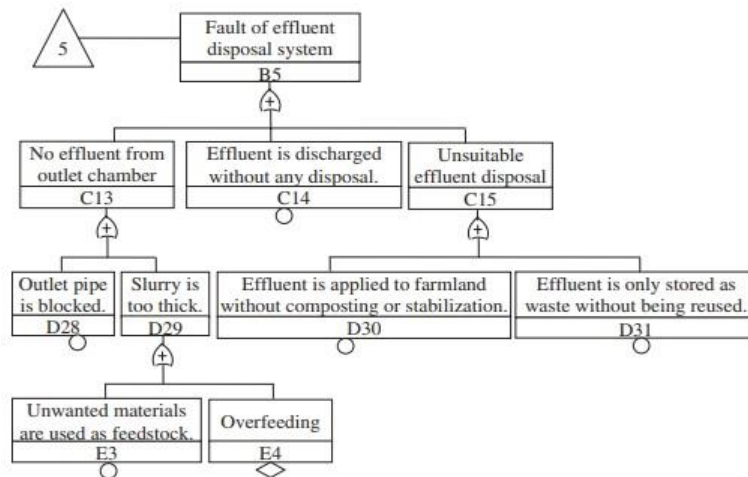


Fig 7. Fault tree of the effluent disposal system

The assessment of potential risks arising from the failure of various components of the system was carried out by creating a fault tree for the biogas system. Based on the fault tree, faults are classified into five main categories and 14 types. The total number of failures is presented in Figure 8, the total number of failures in the studied systems categorized by failure type, and the total number of failures in the studied systems categorized by failure type [28,29,30,31].

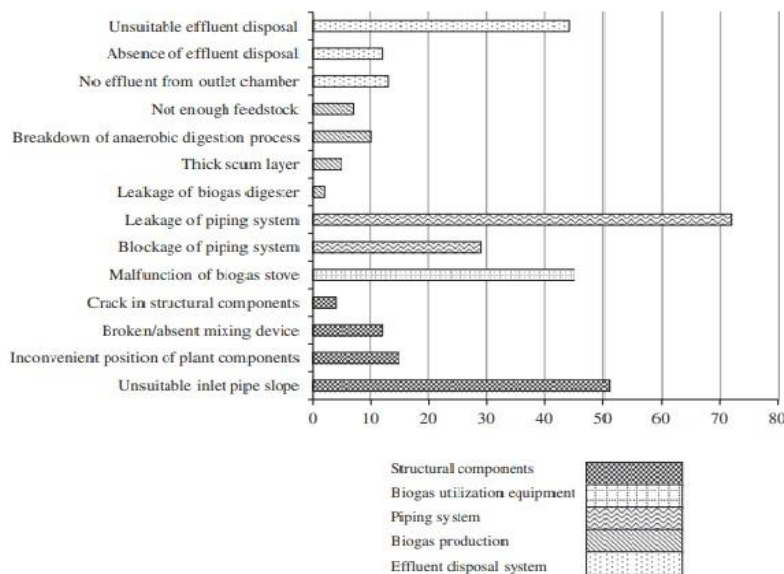


Fig 8. Total number of failures in the studied systems categorized by failure type

## RESULTS AND DISCUSSION

Based on the aforementioned statistical analysis, fault probability of event B1 ( $P_{B1}$ ) is calculated based on fault probabilities of events C1, C2, C3, and C4, as follows:

$$P_{B1} = 1 - (1 - P_{C1}) (1 - P_{C2}) (1 - P_{C3}) (1 - P_{C4}) = 1 - (1 - 47/94) (1 - 15/94) (1 - 16/94) (1 - 4/94) \approx 0,67 \quad (6)$$

Fault probability of event B2 ( $P_{B2}$ ) is based on failure number of event C5 and C6, which is  $45/94 \approx 0,48$

Fault probability of event B3 ( $P_{B3}$ ) is based on failure numbers of events C7 and C8, which is  $69/94 \approx 0,73$ .

Fault probability of event B4 ( $P_{B4}$ ) is 0.26 based on the number of statistical failures, that is, 24, against 94 samples.

Fault probability of event B5 ( $P_{B5}$ ) is calculated based on fault probabilities of events C13, C14, and C15. Event C13, C14, and C15 are not independent events, therefore:

$$P_{B5}=P_{c13} + P_{c14} + P_{c15}=60/94\approx 0 \quad (7)$$

## CONCLUSION

This study shows that FTA is mostly suitable for certain biogas plant reliabilities and further proves that FTA is a compelling analysis tool in biogas technology. Component errors that can lead to abnormal operation of the biogas plant are identified with the help of FTA. This paper defines five subsystems: structural components, biogas equipment for use, pipeline system, biogas production, and wastewater disposal system. Based on the statistical analysis of the target cases, the error probabilities were calculated as 0.67, 0.48, 0.73, 0.26, and 0.64, respectively. Although FTA is a very successful and widely used method for the reliability analysis of a wide range of systems, it has several limitations, such as the inability to model sequence- or time-dependent dynamic behavior and perform quantitative analysis with uncertain failure data. In addition, even with software tool support for FTA, creating and analyzing fault trees requires much manual effort.

## REFERENCES

- [1] Ciula, J., Kowalski, S., Generowicz, A., Barbusiński, K., Matuszak, Z., Gaska, K.: Analysis of Energy Generation Efficiency and Reliability of a Cogeneration Unit Powered by Biogas, *Energies*, pp. 2, 2023
- [2] Kervor, D., Kemper, K.: California Integrated Waste Management Board, California Regulatory Law Reporter 13.2, pp. 161-169, 1993.
- [3] Chorukova, E.: Two-phase anaerobic digestion of corn steep liquor in pilot scale biogas plant with automatic control system with simultaneous hydrogen and methane production, *Applied sciences* 12.12, pp. 6274, 2022.
- [4] Radaković, M.: Biodizel.Biogas. Biomasa, AGM knjiga, pp. 54, Beograd, 2009.
- [5] Rohstoffe, Fachagentur Nachwachsende: Leitfaden Biogas von der Gewinnung zur Nutzung; Bioenergie. biogas. fnr. de (6., überarb. Aufl.), Gülzow-Prüzen, 2013.
- [6] Stricky, B., Kiss, F., Međugorac, M.: Ocenjivanje životnog ciklusa električne energije dobijene iz biogasa u postrojenju 'Mirotin Energo' u Vrbasu, *Savremena poljoprivredna tehnika* 40.2, pp. 77-86, 2014.
- [7] Petravić Tominac, V.: Positive socio-economic and ecological effects of biogas production by anaerobic digestion, *Glasnik Zaštite Bilja* 46.3., pp. 80-92, 2023.
- [8] Huerta-Reynoso, E. A., Gómez, J. A.: Biogas Power Energy Production from a Life Cycle Thinking, 2018.
- [9] Tanasić, Lj.: Proizvodnja energije iz poljoprivrednog otpada i korišćenje nus proizvoda kao organskog đubriva, pp. 25, 2022.
- [10] Petrović, P., Petrović, M.: Sekundarne sirovine iz poljoprivrede u proizvodnji biogoriva, *Zbornik Međunarodne konferencije o obnovljivim izvorima električne energije—MKOIEE* 3.1, pp. 63-73, 2018.
- [11] Gaduš, J.: Iskustva sa gorivim ćelijama na biodizel, *Časopis za procesnu tehniku i energetiku u poljoprivredi/PTEP* 9.1-2, pp. 1-4, 2005.
- [12] Fabijanić, T.: Biodizel i bioplin. Diss. Karlovac University of Applied Sciences, The Department of Mechanical Engineering, 2017.
- [13] Biogas eV, Fachverband: Biogas-Safety first, Smernice za bezbednu upotrebu tehnologije biogasa." Freising, Germany, 2016.
- [14] Harms-Ringdahl, L.: Safety analysis: principles and practice in occupational safety, CRC Press, 2001.
- [15] Milovanović, Z.: Termoenergetska postrojenja - Tehnološki sistemi, projektovanje i

- izgradnja, eksploatacija i održavanje, pp. 628, 2019.
- [16] Ekanathan, M., Yeldose, B., Kallanickal, P., Mangalath, G.: Root cause analysis to identify the problem causing turbine failure, international journal of engineering science and innovative technology, pp. 527-535, 2013.
- [17] Chandrakar, J., Kumar, R.: Reduction of breakdowns in food processing plants through failure analysis, International journal of advanced engineering research and studies, pp. 212-214, 2015.
- [18] Marhavidas, P., Koulouriotis, D., Gemeni, V.: Risk analysis and assessment methodologies in the work sites: On a review, classification and comparative study of the scientific literature of the period 2000- 2009, Journal of Loss Prevention in the Process Industries, 2011.
- [19] Lipol, S. L., Baig, A.A., Ruzli, R., Buang, B.A.: Reliability analysis using fault tree analysis, International journal of chemical engineering and applications, pp. 169-173, 2013.
- [20] Sinnamon, M., Andrews, J. D.: Improved efficiency in qualitative fault tree analysis, Quality and Reliability Engineering International, pp. 285-298, 1997.
- [21] Čepin, M.: Analysis of truncation limit in probabilistic safety assessment, Reliability Engineering & System Safety, pp. 395-403, 2005.
- [22] Kostić-Stanković, M., Makajić-Nikolić, D., Vujošević, M.: Korišćenje stabla neispravnosti u upravljanju rizikom oglašavanja, pp. 115-121, Zbornik radova SPIN 2011, Beograd, 2011.
- [23] Lindhe, A., Norberg, T., Rosén L.: Approximate dynamic fault tree calculations for modelling water supply risks, Reliability Engineering & System Safety, pp. 61-71, 2012.
- [24] Makajić-Nikolić D.: Novi pristup analizi pouzdanosti sistema primenom inverznih Petrijevih mreža. Diss. University of Belgrade, Faculty of Organizational Sciences, 2012.
- [25] Roslyn, S. M, Andrews, J. D.: Improved accuracy in quantitative fault tree analysis, Quality and reliability engineering international, pp. 285-292, 1997.
- [26] Cheng, S., Li, Z., Mang, H.P., Neupane, K., Wauthélet, M., Huba, E. M.: Application of fault tree approach for technical assessment of small-sized biogas systems in Nepal, Applied Energy, pp. 1372-1381, 2014.
- [27] Reay, K. A., Andrews, J. D.: A fault tree analysis strategy using binary decision diagrams, Reliability Engineering & System Safety, pp. 45-56, 2002.
- [28] Vesely, W. E.: Fault tree handbook, Washington, DC: Systems and reliability research, office of nuclear regulatory research, US Nuclear Regulatory Commission, 1981.
- [29] Grant, I. W., Coombs, C.F., Moss, R. Y.: Handbook of reliability engineering and management, pp.325, 1988.
- [30] Marvin, R., Hoyland, A: System reliability theory: models, statistical methods, and applications. pp. 396. John Wiley & Sons, 2003.



**XIII International Conference Industrial  
Engineering and Environmental  
Protection 2023 (IIZS 2023)  
October 05-06, 2023, Zrenjanin, Serbia**

---

# **Session 3**

# **Designing and Maintenance**



## SOFTWARE INFORMATION SECURITY MANAGEMENT FOR GOVERNMENT AUTHORITIES

Rade Dragović<sup>1</sup>, Sanja Stanisavljev<sup>2</sup>, Dalibor Dobrilović<sup>2</sup>, Dragan Dragović<sup>3</sup>,  
Vladimir Milošev<sup>2</sup>

<sup>1</sup>Institute for standards and technologies, Belgrade, Serbia  
e-mail: [rade.dragovic@instate.biz](mailto:rade.dragovic@instate.biz)

<sup>2</sup>University of Novi Sad, Technical Faculty "Mihajlo Pupin", Zrenjanin, Serbia  
e-mail: [sanja.stanisavljev@tfzr.rs](mailto:sanja.stanisavljev@tfzr.rs), [dalibor.dobrilovic@tfzr.rs](mailto:dalibor.dobrilovic@tfzr.rs), [vladimir.milosev@tfzr.rs](mailto:vladimir.milosev@tfzr.rs),

<sup>3</sup>Serbian Business Registers Agency, Belgrade, Serbia  
e-mail: [drdragovic@apr.gov.rs](mailto:drdragovic@apr.gov.rs)

**Abstract:** This article treats two very important items in the functional matrix of the state bodies work: information security and software development. Information security is not only a recommendation with content in the domain of organization, technology, and procedure but is also defined by legal and by-laws. Lately, software development has been increasingly outsourced, so it is important for state authorities to know that software development is no longer a free assessment of the client and programmer, how and what will be developed, and to what extent the software will be delivered.

**Key words:** software development, standards, information security, state authority, cyber security.

### INTRODUCTION

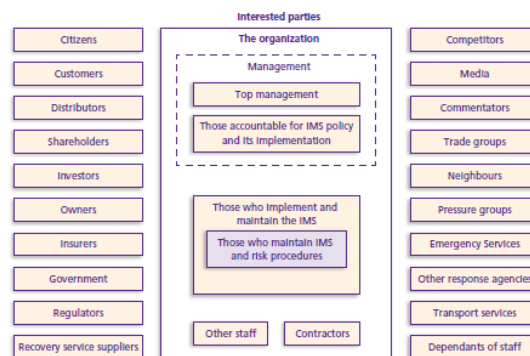
Digitalization of the state bodies through information systems implies the application of appropriate laws and standards in the management of ICT systems. The increased number of existing information systems is a consequence of legislative changes and digitization of work of the state bodies so that they can respond to the specifics of work tasks related to the maintenance of the existing state and the improvement of their information systems both to other state bodies and to legal and natural persons. The initial requirements refer to the requirements by the law, prevention of security incidents, system control and management of access to information systems, and the prevention of data leaks, but also the technological monitoring of adopted security acts, the introduction of technological measures for monitoring and preserving data security and documenting the application of security solutions within the implemented ICT systems. Considering the number and complexity of these systems, as well as the fact that their operator is the state as well as relevant ministries (which establish and maintain them), it is necessary to manage software development organizational, technological, and procedural according to the requirements of the Information Security Act and the ISO/IEC 27001 - Security standard information, cyber security and privacy protection - Information security management systems - Requirements.

### INFORMATION SECURITY

Frequent incidents in the immediate and wider environment impose the need to strength the field of information security in state bodies and to establish a strengthened framework for information security management called ISMS (Information security management systems). ISMS should represent a systematic approach for establishing, implementing, functioning, monitoring, reviewing, maintaining and improving the information security of the state body, in order to achieve business goals, but the risk matrix must not be ignored. ISMS must be based on an assessment of information security risks and the level of acceptability of such risks by the state authority in such way that effectively and efficiently treats the risks and manage the risks in an appropriate manner. Requirements for the protection of information assets, whether

they are legal, regulatory, contractual or as a consequence of risk management and the application of appropriate controls, when necessary, contribute to the successful implementation of ISMS. The requirements of the standard mean all the obligations that the standard stipulates that the state body must fulfill [1].

The Cyber Security Program should be developed for the entire organization of the state body, including all software through business and IT-related functions, considering the fact that attacks and threats to information security can occur anywhere within the state body. It is necessary to implement the requirements of the standards ISO/IEC 27001, ISO/IEC 27701, ISO/IEC 27032, ISO/IEC 22301, ... in areas that include security in the intranet/internet space, i.e. intranet/internet security issues that focus on bridging results risk analysis between different domains of information security in intranet/internet space. According to the stated standards, it is necessary to implement technical guidelines for solving intranet/internet security risks, including social engineering attacks, hacking, spyware and attacks using other potentially malicious malware software. These technical guidelines should provide controls for the treatment of these risks, including controls for preparing responses to attacks from malicious software (malware), malware organizations for detecting and monitoring attacks [2]. It is necessary to generate a framework for efficient and effective information exchange, coordination and incident management among interested parties in the Internet space. Stakeholders that may be involved are employees, clients and third parties, which may be different types of organizations or individuals, as well as providers, which include service providers as well as all those identified by the risk matrix.



**Fig. 1.** Stakeholders by ISO 22301 [2]

The implementation of the requirements of the standard through the delivery of the Cyber Security Program according to the requirements of the ISO/IEC 27032 standard should include at least the following units: Stakeholders, Information means (information carriers), Threats against intranet/internet space security, Roles of interested parties in information security, Guidelines for interested parties, Information security controls [4].

Requirements of the information security standard ISO 27001 in the domains[5]:

- A.5 Organizational controls, 37 control requirements
- A.6 Human controls, 8 control requirements
- A.7 Physical controls, 14 control requirements
- A.8 Technological controls, 34 control requirements

(a total of 93 requirements) inevitably refer to numerous requirements for software development.

## SOFTWARE AND STANDARDS FOR SOFTWARE DEVELOPMENT

According to the ISO/IEC 2382 standard, the software is "the whole or part of the programs, procedures, rules and related documentation of an information processing system". State authorities rarely use open-source operating systems and more often vendor development. Application software consists of program/code units made for a specific purpose, according to user needs. This type of software is not directly related to computer hardware, but relies on

system software, especially the operating system, to perform its functionality. The need to develop application software most often arises when a state body wants to solve a problem or get a new service.

Any problem that is solved by software development can be solved in several ways. The methods differ from each other in terms of efficiency, precision, comprehensibility, usefulness, modifiability and/or other characteristics. The main goal of software development is for the software to be comprehensive, stable, understandable, easy to maintain and efficiently works for what it was created for. The development of certain software is almost never finished, but it is constantly improved according to the requirements of the market, the customer, changes in legislation, perceived deficiencies or other procedural, organizational or technological needs.

All over the world there is a large number of software manufacturers in every area of life, business of government bodies or industry when there is not only one exclusive solution for a certain area.

In order to develop quality software, it is necessary that its development is based on adopted standards (international, national, internal) and that numerous evaluations are carried out during its life cycle. The expansion of software development, in various fields, has been accompanied by the proliferation of standards, procedures, methods and tools for software development and management. Proliferation has created difficulties in managing software, especially software that is integrated into products and services. This led to the need to define a common framework for the software discipline that would help everyone who deals with software to "speak the same language" in the design, development, management and maintenance of software in their environments.

ISO/IEC IEEE 12207 Systems and software engineering - Software life cycle processes. The standard established a common framework for software life cycle processes, with well-defined terminology that the software industry can refer to. It contains processes, activities, and tasks that are applied during the acquisition, supply, development, operation, maintenance, or disposal of software systems, products, and services. These life cycles are achieved through the involvement of stakeholders, with the ultimate goal of achieving user satisfaction. The standard applies to the acquisition, supply, development, operation, maintenance, and disposal (regardless of whether it is done internally or externally within the framework of a government body) of software systems, products, and services and the software part of any system, Software includes the software part of the firmware. There are also included aspects of the system definition needed to provide context for software products and services. This standard also provides processes that can be used to define, control and improve software life cycle processes within a government agency, department or project. The processes, activities and tasks of this document can also be applied during the procurement of systems containing software, alone or in combination with ISO/IEC/IEEE 15288, Software and systems engineering - Systems life cycle processes. This international and national standard establishes a common process description framework that describes the life cycle of human-made systems. It defines a set of processes and related terminologies from an engineering point of view. These processes can be applied at any level in the hierarchy of a system's structure. Selected sets of these processes can be applied throughout the entire life cycle to manage and perform the systems phase of the life cycle. This is achieved through the involvement of all interested parties, with the ultimate goal of achieving user satisfaction [6].

The basic premise of the standard is that the application and practice of software engineering is a relatively young discipline comparing to traditional branches of engineering. Therefore, the control that usually accompanies traditional engineering projects is not always achievable when it comes to software. Underlying the philosophy of ISO/IEC 12207 is that aspects such as software development and maintenance must be conducted in a manner that represents engineering. The processes specified in this standard form one comprehensive set. Each organization, depending on its goals, can choose the appropriate subset to achieve the goals. The standard is designed in such a way that can be adapted to the needs of the organization, project or specific application. It can be applied in cases where the software is an independent entity or an integral part of a complex system [6].



The standard describes the architecture of software life cycle processes without specifying the way of execution of the activities and tasks that the processes contain. It does not prescribe a specific software life cycle model or method for developing software. The activities and tasks of the development process are selected and mapped into the selected life cycle model and may overlap or mutually influence each other, and be executed iteratively or recursively. ISO/IEC 12207 provides a framework in which processes, activities, and tasks can be identified, planned, and adequately responded to.

In order to ensure an easier application of the ISO/IEC 12207 standard, ISO/IEC TR 24748-3 System and software engineering - Life cycle management - Part 3: Guidelines for the application of ISO/IEC 12207 (System and software engineering - Software life cycle processes) was published. The standard explains how ISO/IEC 12207 can be used in the development of different types of software and which processes, defined by the standard, are relevant in each case. Fundamental life cycle models are also defined and supported by examples: waterfall, incremental, and evolutionary [6].

The evaluation and standardization of tools used in the process of developing information systems create the possibility that the quality of the process itself as well as the final products will be at the desired and expected level. Viewed from the perspective of complex information systems in the development and implementation of which several state authorities participate, the application of standards not only ensures the appropriate quality of the final software as a product and development process but also creates opportunities for the exchange of projects between individual state authorities, facilitates user training and creates conditions for common work on projects of representatives of various state bodies.

Analogously to living organisms, the software is considered to arise, grow, mature, and disappear, so this process is called the term "system life cycle". The life cycle of an information system based on information technologies includes several stages: planning, analysis, design, implementation, and maintenance.

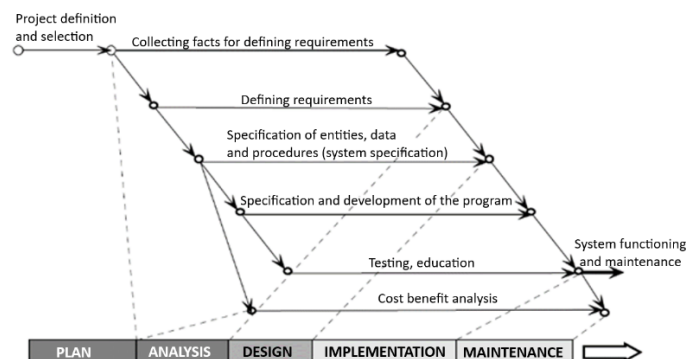


Fig. 2. Presentation of software development phases based on ISO 12207 [6]

Planning the development of information systems is one of the most important and difficult functions in modern management. Information system development planning is carried out continuously in order to change things as business circumstances change. The development planning of an organization's information resources requires the achievement of an architectural framework in which special parts of the system will be harmoniously integrated and which will enable the staged development of the information system and that various special subsystems in the organization can be branched out by various teams of people, successfully planning and rationally using the necessary and available resources. The main purpose of planning and setting up an architectural framework is to achieve information consistency [4].

Information system analysis is the second stage in the life cycle process of information system development. The analysis aims to reveal important information about three key aspects of the analysis: a) analysis and description of the object-system, b) analysis of the existing information system, c) identification of business and user information requirements.

In order to correctly evaluate the existing software of a state body, it is necessary to understand the mission, functions, structure, form, culture, climate, goals, environment and behavior of that state body. The immediate goals of the analysis of the existing information system are an accurate description and assessment of its properties, and the main purpose is to determine the difference between the properties of the existing software and the desired properties of the newly designed and developed software, which would effectively and efficiently serve in setting and achieving the goals of the state authority for which it is developed. The final and perhaps the most important segment of the analysis is the identification of user requirements. Users differ according to the nature of the work they perform, the positions they occupy in the structure of the state body, their cognitive and other capabilities, and therefore their functional requirements are also very different. Investigating the content of those requests, the way and form of their presentation, time and place of delivery, frequency, volume, response time and similar are very difficult, long-term and responsible tasks of the analyst. Much of this information can be successfully found out during the execution of the planning phase however continuity is ensured and more comprehensive and deeper analysis is carried out with changed purpose.

The design of the information system should fully answer the question: how will the system enable the satisfaction of the user needs? In this phase of system development, the logical model of the new system is conceived, the model is developed and the database is designed, the process model is developed, manual and automated procedures are specified, input/output screen forms are designed, reports, printed documents, user dialogue procedures with the system, computer program specifications and program module design, control system design and many other aspects and details of design work. System design can be defined as drawing, shaping, planning, sketching or arranging many special elements and putting them together into a powerful and unique whole. The analysis system answers the question "What does the system do?" and "What should he do?" to satisfy user requirements, while system design focuses on the key and most complex problem: how to develop the system and how it should work to satisfy those requirements. System design is a skill and a creative process of finding the best solutions and answering the question "How to do it the best?" Information system designers, by solving all these problems and key design tasks, look for possible alternative "design solutions" that will satisfy the identified information needs of the designer, in the best possible way, during the analysis phase.

The implementation of the information system is very important and in most cases, from the point of view of the end users, the key stage of development. The system can be planned, the analysis carried out, and the design conceived and implemented at an enviable expert level, but its functionality and success will depend on the way of planning and realization of its implementation. Such a plan and its implementation include many important aspects of implementation: a) preparation of implementation, b) implementation and testing of the technology, c) programming, d) testing software products, e) testing of inputs, outputs, databases, and control procedures, f) user education, g) system conversion.

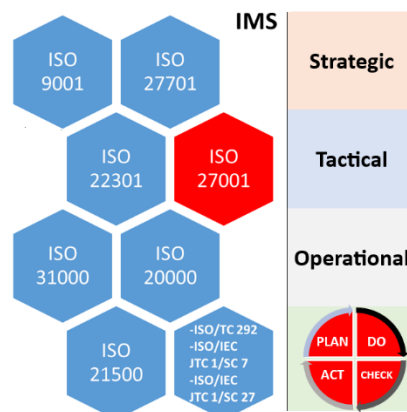
Implementation is the process of complex and responsible transfer of the system from the hands and responsibilities of analysts and designers to the hands of users and operational personnel responsible for the functioning and maintenance of the information system. Therefore, implementation includes various processes of acquisition, installation, testing, learning, conversion, documentation and its a vital step in ensuring the success of the information system of the state body.

System maintenance is the last stage in the life cycle of the development of the information system of a state body. When the system is fully implemented and put to use by the state authority and its users, the function of its operation and maintenance begins. During the life cycle of the system, numerous changes will occur; many new functional requirements will appear, old functional requirements will be modified or replaced, the real world will change, the environment of the state body, the organization of the state body itself, many technological changes will occur, which will all cause corresponding changes in the model and structure of the information system. Therefore, it is not only a matter of changing existing programs and writing new ones to satisfy new information requirements, but also the development of new

versions that require and cause significant changes and modifications in the previous development phases of the system. System maintenance includes the activities of monitoring, evaluation and modification of the system, in order to satisfy desired and necessary continuous improvement.

## INFORMATION SECURITY REQUIREMENTS MODEL FOR SOFTWARE

The production of software through standardized phases of the life cycle requires additional efforts in order to establish a software product with the required functionalities. In addition to the initial functionality required for the software by the state authority, which solves some procedural needs in the jurisdiction, it is necessary during all phases to establish and implement measures related to information security. Information security requirements for software are not just a favorable feeling of someone but are defined by the legislation of the state through the Law on Information Security, the Law on Protection of Personal Data, the Law on Critical Infrastructure, the Law on Electronic Services as well as through the acts in the Criminal Code of the Republic of Serbia [7]. Behind the mentioned laws there are by-laws, regulations and other legal procedural acts as well as special state bodies that control the implementation of the stated. In the vast majority of state bodies, persons who perform tasks in the field of information security have been appointed. There is no modern state body that does not use information technologies in its work. All of the above describes the necessary procedural, organizational and technological framework as a prerequisite for a functional information security management system – ISMS.



**Fig. 5.** Information security software development matrix

The information security management system must be placed in the strategic, tactical and operational domain, during which it must be coordinated with the actions within its department, but also with other state services. The strategic, tactical, and operational domains must be implemented in the organizational, technological, and procedural framework by fully applying the PDCA - Deming cycle [8].

Software is a technological category that has defined requirements in international and national standards of modern countries for many years. In addition to the initial requirements of the ISO 27001 standard - Information security management systems, it is necessary to pay special attention to the fact that the software is not designed to function on a desert island but in interaction with other government bodies. It is necessary to implement the following requirements: ISO 27701 - Privacy information management systems, ISO 20000 - Information technologies - Service management through the application of the well-known principles of ISO 9001 - Quality management systems with ISO 10001 - Quality management - User satisfaction, ISO 31000 - Risk management and ISO 21500 – Project management [8]. The above is only a basis that should be expanded, specifically for the competence of individual state bodies, with the requirements of ISO/TC 292 - Security and resilience, ISO/IEC JTC 1/SC

7 - Software and systems engineering and ISO/IEC JTC 1/SC 27 Information security, cybersecurity and privacy protection [10].

**Table 1. Experienced recommendations for software information security [10]**

ISO/TC 292 Security and resilience	ISO/IEC JTC 1/SC 7 Software and systems engineering	ISO/IEC JTC 1/SC 27 Information security, cybersecurity and privacy protection
ISO 22301 Business continuity management systems	ISO/IEC/IEEE 26511 Requirements for managers of information for users of systems, software, and services	ISO/IEC 27001 – Information security management system
ISO 22320 Emergency management	ISO/IEC/IEEE 26531 Content management for product life-cycle, user and service management documentation	ISO/IEC 18033 – Encryption algorithms
ISO 22376 Authenticity, integrity and trust for products and documents	ISO/IEC 26550 Reference model for Product Line Engineering and Management	ISO/IEC 19772 – Authenticated encryption
ISO 28000 Security management system	ISO/IEC 25000 Systems and software Quality Requirements and Evaluation	ISO/IEC 29192 – Lightweight cryptography
ISO 22341 Protective security	ISO/IEC/IEEE 12207 Software life cycle processes	ISO/IEC 15408 – Evaluation criteria for IT security
ISO 22316 Organizational resilience	ISO/IEC 33000 Family Process assessment	ISO/IEC 30111 – Vulnerability handling processes
ISO 22361 Crisis management	ISO/IEC 29155 Benchmarking	ISO/IEC 27035 Information security incident management
...	ISO/IEC 10746 Open Distributed Processing	ISO/IEC 27036 Cybersecurity – Supplier relationships
	ISO/IEC 19770 IT asset management	ISO/IEC 27099 Public key infrastructure
	ISO/IEC/IEEE 29119 Software testing	ISO/IEC 27701 Privacy information management
	ISO/IEC/IEEE 42010 Architecture description	ISO/IEC 29100 – Privacy framework
	...	ISO/IEC 29184 – Online privacy notices and consent
		...

The above table provides guidelines for the analysis of a clear and complete definition of software in the domains of Security and resilience, Software and systems engineering and Information security, and cybersecurity and privacy protection, which represent indispensable members of the initial analysis of the phases of planning, analysis, design, implementation, and maintenance of the software life cycle.

## CONCLUSION

It is necessary to establish an effective way of dealing with information security risks in software development, which should include a combination of multidisciplinary teams and multiple strategies, taking into account all interested parties, legal requirements, organizational knowledge and technological experience. These strategies should include the best practices in the field of state administration with the cooperation of all interested parties (especially competent state authorities: prosecution, police, intelligence services) in order to identify and address information security and risk issues, broad education of clients and employees, providing a reliable resource for initial identification and addressing of specific risks related to intranet/internet security in state bodies with a special emphasis on software (all software in use in individual state bodies) as well as innovative technological solutions that help protect against various cyber attacks.

The given guidelines are focused on providing best practices in government administration to help stakeholders in the intranet/internet space to understand the role of software and act preventively with the goal of playing an active role in solving information security challenges.

## REFERENCES

- [1] Rade Dragovic, FUNCTIONAL RECOMMENDATIONS FOR THE ESTABLISHMENT OF JUDICIAL INFORMATION SYSTEM, ISDOS - Information system of the state bodies of Serbia, Conference Proceeding 2010
- [2] Rade Dragović, Dragan Dragović, Bojan Perović, Đuro Klipa, STRATEGIC MANAGEMENT IN THE JUDICIARY BASED ON DECISION SUPPORT SYSTEMS, YUINFO Conference Proceeding 2013
- [3] ISO 22301 - Security and resilience - Business continuity management systems – Requirements, International Organization for Standardization
- [4] Zvonimir Ivanović, Rade Dragović, Sergej Uljanov, STRATEGIC REGULATION MODEL ON THE HIGH-TECH CRIME VULNERABLE TARGETS, WESTERN BALKANS: FROM STABILIZATION TO INTEGRATION, International Scientific Conference, Conference Proceeding 2011
- [5] ISO/IEC 27001 - Security standard information, cyber security and privacy protection - Information security management systems – Requirements, International Organization for Standardization
- [6] ISO 12207 - Systems and software engineering - Software life cycle processes, International Organization for Standardization
- [7] Rade Dragovic, Vladimir Kačanovski, Bojan Perovic, SECURITY POLICY IN JUDICIAL INFORMATION SYSTEM, YUINFO Conference Proceeding 2011
- [8] Rade Dragović, Ivan Peljević, Đuro Klipa, IMPLEMENTATION STRATEGY FOR CRYPTOGRAPHIC PROTECTION IN EJUDICIARY, INFOFEST Conference Proceeding 2012
- [9] Rade Dragović, Bojan Perović, SECURITY POLICY AND RECOMMENDATIONS FOR INCREASING SECURITY DATABASE IN THE JUSTICE INFORMATION SYSTEM, BISEC Conference Proceeding 2012
- [10] Internet source: International Organization for Standardization, website: [www.iso.org](http://www.iso.org)
- [11] Rade Dragović, Bojan Perović, Ljubiša Pešić, Enver Nuhović, Đuro Klipa, RECOMMENDATIONS FOR IMPROVING SECURITY DATABASES IN THE JUDICIAL INFORMATION SYSTEM, YUINFO Conference Proceeding 2012
- [12] Rade Dragović, Miodrag Ivković, Bojan Perović, Đuro Klipa, DATAVEILLANCE AND DATA MINING AS A TECHNOLOGY SUPPORT TO THE PROCESS OF INVESTIGATION, TELFOR Conference Proceeding 2011, IEEE conference
- [13] Vojkan Nikolić, Rade Dragović, INTEROPERABILITY AND SECURITY OF EGOVERNMENT OF REPUBLIC OF SERBIA, TELFOR Conference Proceeding 2014, IEEE conference



## NUMERICAL SIMULATION AND VERIFICATION OF SINK MARKS ON THE MANUFACTURED PLASTIC PARTS

Ivan Matin<sup>1</sup>, Branko Štrbac<sup>1</sup>, Milana Mićunović Ilić<sup>1</sup>, Miloš Ranisavljev<sup>1</sup>, Miodrag Hadžistević<sup>1</sup>, Zorana Lanc<sup>1</sup>

<sup>1</sup>University of Novi Sad, Faculty of Technical Sciences, Novi Sad, Serbia  
e-mail: [matini@uns.ac.rs](mailto:matini@uns.ac.rs)

**Abstract:** Injection molding (IM) is the most suitable process for mass-production of polymer parts. Numerical simulation of injection molding used for analysis of the influence of IM process parameters from the point of sink marks. This method aids in reducing the manufacturing time and increase the dimensional and surface quality of the parts. The influence of injection pressure, packing pressure, and melt temperature on dimensional shrinkage, and sink marks was studied numerically. The findings demonstrate that optimal increasing packing pressure, cooling time and packing time reduces sink marks. Although sink marks do not affect part strength or function, they are perceived to be severe quality defects. Sink marks are caused mainly by thermal contraction during cooling.

**Key words:** sink marks, numerical simulation

### INTRODUCTION

Injection molding (IM) is often used manufacturing processes to produce polymer products. The process converts the polymer pellets to the finished components without grinding and polishing. However, injection molded polymer parts undergo shrinkage during cooling and after the ejection stage, which remains a point of concern owing to its effect on performance. Manufacturer suffers higher losses if the component's size is over the part's permitted tolerance limit. Therefore, the minimization of shrinkage is important. In IM, part geometry, mold design, part material and injection molding process parameters are the critical factors that decides the characteristics of the manufactured components such as shrinkage and sink marks. Hence, these factors must be carefully determined. The part should have uniform wall thickness to ensure uniform cooling throughout the part as cooling time is directly proportional to square of wall thickness. The mold design consists of design of gates, runner, sprue and waterline channel. The gate design includes finding the number of gates, locations, shape and dimensions. Solanki et al. [1] have carried out numerical study to determine best gate location and gate numbers and their influence on shrinkage of the plastic parts. The IM parameters namely packing pressure, packing time, melt temperature, mold temperature, injection pressure, injection time and cooling time should be carefully selected to minimize the defects. Many authors had optimized IM processing parameters and gate numbers to minimize shrinkage, weld line, warpage, and air traps on selected plastic material. The authors observed that the volumetric shrinkage has increased with melt temperature, but it has decreased as the packing pressure and mold temperature increases [2-7]. He et al. [8] had studied experimental and numerical approach to characterize non-linear shrinkage and optimized dimensional deviation of injection-molded plastic part. The authors advocated that cooling rate has highest contribution on non-linear shrinkage while melt temperature has highest contribution on dimensional deviation. Kurt et al. [9] had investigated influence of molding conditions on the shrinkage and roundness of injection molded parts. They concluded that melt temperature and packing pressure has dominating effect on part shrinkage. The Sink marks are undesired depressions on the surface of injection-molded components, and appear frequently on sections with the highest polymer concentration. The authors had analyzed sink marks defects on injection molding using ABS and PE polymer material and reported that packing pressure, packing time, melt and mold temperature were the most influential process parameters. The quality of injected part which is affected by many parameters and the number of variables is

high, that is why the studying task which is required to perform by computer-aided engineering (CAE) can be remarkable. Hence, design of experiment is an acceptable method to reduce the number of numerical experiments and obtain enough information which is used in real experiments.

## MATERIAL AND METHODS

Polypropylene (PP) is a widely used semi-crystalline polymer, which imparts high tensile strength to weight ratio, excellent chemical inertness, resistance to moisture, good fatigue life and low density. Therefore, "PP M108" was selected as a polymer material for this study. This is general purpose homopolymer having easy processability and high strength. It was observed from the literature that the impressive study of IM processing parameters on part shrinkage have been carried out over the years and advocated the significance of packing pressure, packing time and melt temperature. However, a little work has been reported on sink marks. Furthermore, complex plastic part like gear with large face width, need more research in this domain. Present study aims to design and develop mold and conduct experimental and numerical study to discover the impact of IM processing factors namely packing pressure, packing time, and melt temperature on shrinkage, mass and sink marks of the plastic part. The outcomes of this study are hoped to be useful to academics and manufacturers.

### Experimental setup

The authors used IM machine called Allrounder 270s Compact by ARBURG Company. The determinate IM parameters are presented in Table 1.

**Table 1.** The IM parameters

The parameters	Values
Material Grade and Material Supplier	PP M108
Packing pressure (MPa)	170
Injection pressure (MPa)	180
Maximal melt temperature (°C )	280
Mold Temperature (°C )	65
Melt Temperature (°C )	240
Transition temperature (°C )	130
Injection Time (s)	7
Estimated cycle time (s)	19
Actual cycle time (s)	21
Transition temperature (s)	111
Recommended ejection temperature (°C)	105
Maximal estimated shear stress (MPa)	0.28
Max sink marks estimate (mm)	0,14
Maximal clamp open time (s)	5
Maximal shink marks (mm)	0,054

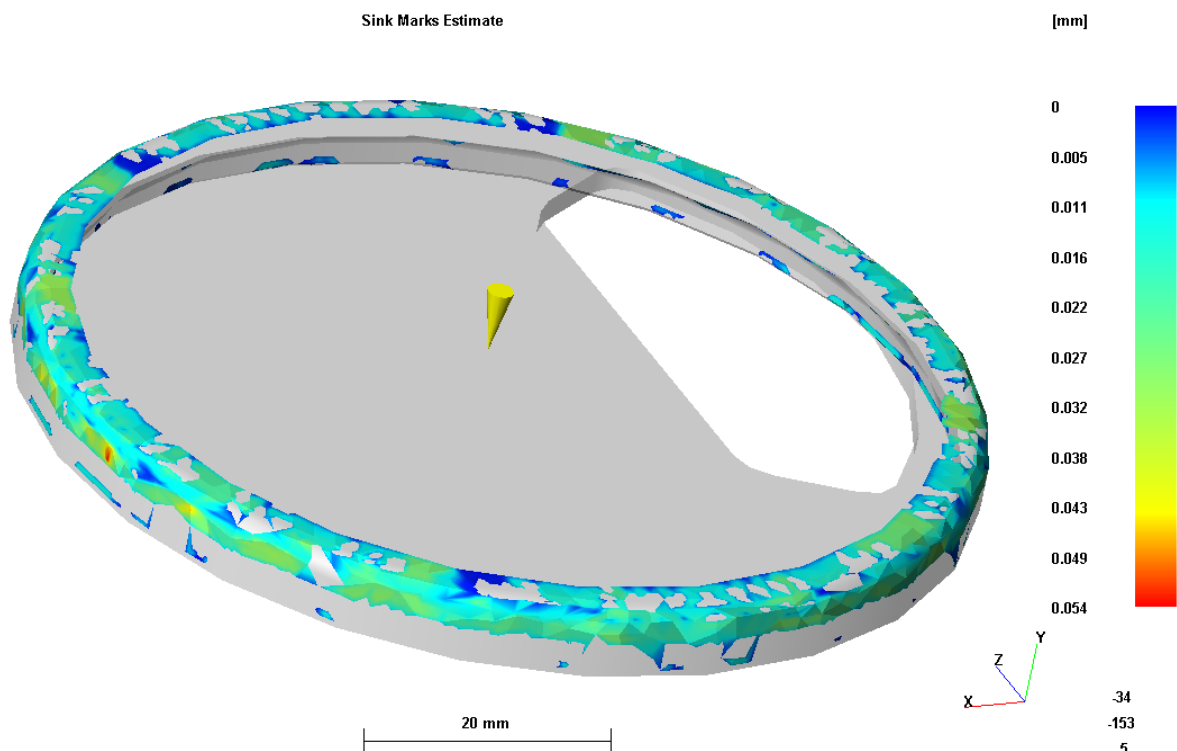


## Numerical simulation

The numerical modeling process begins with the import of geometry, mesh generation, polymer selection, analysis sequence selection, injection molding condition implementation, and IM process parameter selection. This was carried out to predict the shrinkage, mass and sink marks at a set of IM parameters and compare the same with experimental results. It includes CAD modelling, meshing, determine the IM parameters and analyses of numerical simulation results. The pressure drop is important factor used to determine the confidence of fill result. With experimental value of 180 MPa for the maximum injection pressure limit, the simulation software tends to be conservative in indicating what can be achieved. Some molding machines can inject material at up to 300 MPa, so a knowledge of the performance of typical machines to be used in production can enable better conclusions to be drawn about the viability of the appropriate pressure drop in case study.

## RESULTS AND DISCUSSION

The effect of IM process parameters on shrinkage and sink marks has been discussed for many decades. As a matter of fact, shrinkage is inherent property of polymer and it should be precisely handled to improve the product quality. Especially in the thick part improper setting of packing pressure, packing time and melt temperature may stimulate localize shrinkage that generates the sink marks. Hence, these IM parameters were carefully monitored and their impact was recorded in terms of diametric shrinkage, mass and depth of sink marks. The obtained results would have to make a balance between the selected outputs. The sink marks distribution is shown in Fig. 1.

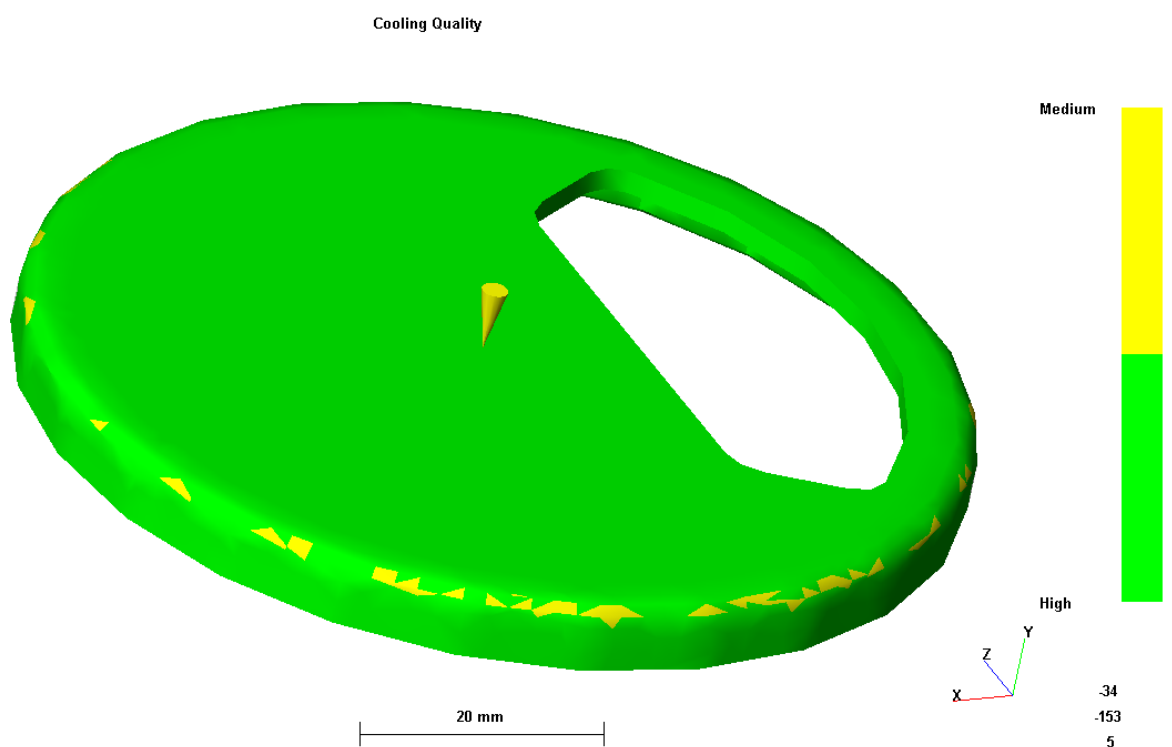


**Fig. 1.** The estimated and shaded sink marks

This result indicates the presence and location of sink marks (and voids) likely to be caused by features on the opposite face of the surface. Sink marks typically occur in moldings with thicker sections, or at locations such as opposite ribs, bosses or internal fillets. The result does not indicate Sink marks caused by locally thick regions, but it is not necessary. As Sink Marks

are a visual rather than a structural defect, the result should be evaluated against the part's visual design specifications. Lighter colors and textured surfaces tend to make Sink Marks less visible. The result index indicates a degree of severity of depth as affected by the material, part geometry, position relative to the injection location and mold filling conditions. This topic applies to Sink Marks Estimate and Shaded, because both results are identical. The way they display the result differs. The Sink Mark Estimate result displays the calculated depths of the Sink Marks, and shows a legend to detail the depth differences. The maximal sink mark value is 0.054 mm.

The cooling is very important stage of the IM process, because the cooling time is most significant in the entire IM cycle time. The design of the cooling channel layout is currently carried out by experienced designers who usually take as reference a set of geometric criteria based on their experience. The design is performed manually and the results are validated by means of numerical simulation software (Pro/Plastic Advisor). If the result indicates that the design presented does not assure the quality requirements of the part, it is modified again through an iterative trial and error process. The cooling quality results is shown in Fig. 2.

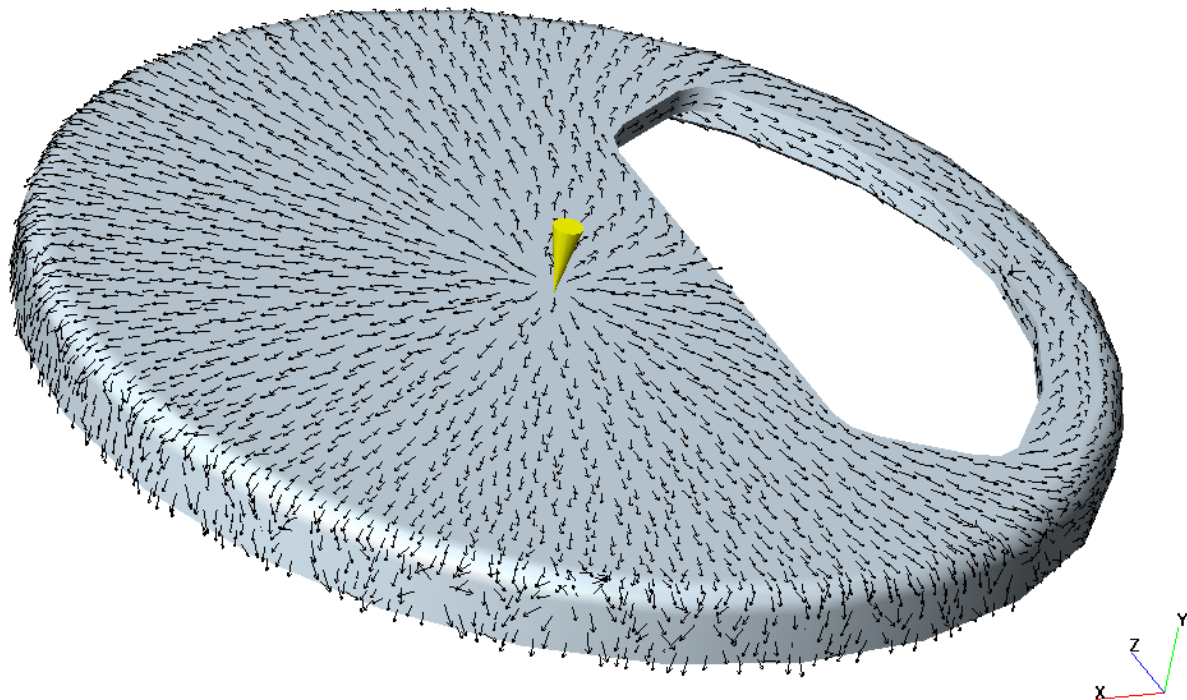


**Fig. 2.** The cooling quality results

The cooling quality results is show where heat tends to stay in a part due to its shape and thickness. The part is located in the center of mold, without any cooling circuits and held there for a fixed indicated period of time is 9 (s). The cooling distribution is very good, because there are most green regions in the part, and only few are yellow. There are no red regions. Cooling quality results are a combination of the surface temperature variance (mainly affected by shape) and freeze time variance (mainly affected by thickness) results.

The next simulation result is skin orientation. The result of the skin orientation indicates a degree of severity of depth as affected by the material, part geometry, position relative to the injection location and mold filling conditions. Changing any of these would allow you to determine its contribution to the Sink Marks severity. The Skin Orientation result provides an indication of the principal molecular alignment direction for a non-filled material, or the principal fiber orientation direction for a fiber-filled material, on the outside of the part. The skin orientation of a particular location in the part is derived from the velocity vector of the melt front when it reached that location in the part. Because the skin is in immediate contact with the

mold and freezes very quickly, the velocity vector gives the most probable orientation at the skin. The skin orientation result is shown in Fig. 3.



**Fig. 3.** The skin orientation result

The Skin Orientation result is useful for estimating the mechanical properties of a part. For example, the impact strength is typically much higher in the direction of skin orientation. When using fiber-filled polymers, the tensile strength is also higher in the direction of skin orientation, because the fibers on the surface are aligned in that direction. Skin orientation generally represents the direction of strength. For plastic parts that must withstand high impact or force, the gate location can be designed to give a skin orientation in the direction of the impact or force. The linear shrinkage of a part also depends on the skin orientation. For unfilled polymers, the shrinkage in the direction of skin (flow) orientation is greater than in the direction of core (transverse) orientation.

## CONCLUSION

As Sink Marks were a visual rather than a structural defect, the result should be evaluated against the part's visual design specifications. Lighter colors and textured surfaces tend to make Sink Marks less visible. Sink Marks appear as depressions on the surface of a molded part. These depressions are typically negligibly small (max 0,054 mm), however they are often quite visible, because they reflect light in different directions to the part. All previously written shows that the IM parameters, the IM machine and the material are optimally chosen. The manufactured plastic part has high dimensional accuracy and surface quality. The IM process is fully automated and efficient.

## REFERENCES

- [1] Solanki, B.S., Sheorey, T., Singh, H., Experimental and numerical investigation of shrinkage and sink marks on injection molded polymer gears: A case study, *International Journal on Interactive Design and Manufacturing*, Vol. 16, pp. 1653–1667, 2022.
- [2] Guo, G., Investigation on surface roughness of injection molded polypropylene parts with 3D optical metrology., *International Journal on Interactive Design and Manufacturing*, Vol.16, pp. 17–23, 2022.
- [3] Hohlweck, T., Fritsche, D., Hopmann, C., Validation of an extended objective function for the thermal optimisation of injection moulds, *International Journal of Heat and Mass Transfer*, Vol. 198, pp. 123-133, 2022.
- [4] Abdul, R., Guo, G., Chen, J.C., Yoo, J.J.W., *International Journal on Interactive Design and Manufacturing*, Vol.14, pp. 345–357 2020.
- [5] Guo, G., Investigation on surface roughness of injection molded polypropylene parts with 3D optical metrology, *International Journal on Interactive Design and Manufacturing*, Vol. 16, pp. 1653–1667, 2022.
- [6] Annicchiarico, D., Alcock, J.R., Review of factors that affect shrinkage of molded part in injection molding, *Material Manufacturing Process*, Vol. 29, pp. 662–682, 2014.
- [7] Moayyedean, M., Abhary, K., Marian, R., Gate design and filling process analysis of the cavity in injection molding process, *Advances in Manufacturing*, Vol. 4, pp.123–133, 2016.
- [8] He, X., Wu, W., A practical numerical approach to characterizing non-linear shrinkage and optimizing dimensional deviation of injection-molded small module plastic gears, *Polymers*, Vol. 13, No.13, 2021.
- [9] Kurt, M., Kaynak, Y., Kamber, O.S., Mutlu, B., Bakir, B., Koklu, U., Influence of molding conditions on the shrinkage and roundness of injection molded parts, *The International Journal of Advanced Manufacturing Technology*, Vol. 46, pp. 571–578, 2010.



## ANALYSIS OF THE DYNAMIC BEHAVIOR OF HYDRO AGGREGATES WITH AN INSTALLED CAPACITY OF 55 MW

Slobodan Juric<sup>1</sup>, Slavica Prvulovic<sup>2</sup>, Jasna Tolmac<sup>2</sup>, Luka Đorđević<sup>2</sup>, Ljubisa Josimovic<sup>3</sup>, Milos Josimovic<sup>2</sup>

<sup>1</sup> High school "CEPS-Center for Business Studies" Kiseljak, Bosnia and Herzegovina

<sup>2</sup>University of Novi Sad, Technical Faculty "Mihajlo Pupin", Zrenjanin, Serbia

<sup>3</sup>College of Textile Engineering, Leskovac, Serbia

e-mail: [prvulovicstavica@yahoo.com](mailto:prvulovicstavica@yahoo.com)

**Abstract:** The main task of the research was the analysis of the dynamic behavior of the Hydro unit, based on the monitoring of its current operation and operation between two turnarounds, analysis of rotor vibrations in all operating modes of Hydro aggregates (inaction, transient mode, low load, nominal load), in accordance with the international standard ISO 7919. Analysis includes: analysis of the overall level of vibrational displacement, spectral analysis, DC analysis of the position of the sleeve in the bearing, analysis of the kinetic path of the sleeve, orbital and sequence analysis, air gap analysis, temperature and correlation analysis. It is necessary to develop such a diagnostic system that, in parallel with the installed COMPASS system in Hydroelectric power plants, can validate measurement data and adjust the installed system. On the basis of all measurements, it was necessary to: assessment of the dynamic state of Hydro aggregates, analyze the dynamic behavior and, based on that, determine the stability of the excitation forces, i.e., malfunctions in operation, and give recommendations for further exploitation. On the basis of the performed analyses, an assessment of the condition of the Hydro aggregates, a diagnostic finding and a proposal for corrective actions were given.

**Key words:** Hydroelectric power plants, Hydro aggregate, dynamic behavior, vibrations

### INTRODUCTION

The main causes that lead to the failure of Hydroelectric power plants are: imbalance, misalignment, bearing bearings, mechanical looseness, thermal bending of the rotor, looseness of the rotor, looseness of winding slack, turbines, pumps, etc.[1, 2].

The following problems that create imbalance are: uneven accumulation of dirt on the rotor blades, lack of homogeneity in castings parts (such as bubbles, air holes), eccentricity of the rotor, roll deflection, machine design errors, uneven distribution of mass on the electric motor of the rotor or wing, uneven erosion and corrosion of the pump impeller, lack of balance weight, bent shaft, etc.[3, 4].

Vibrations of technical systems are the result of the mutual interaction of excitation and the sensitivity of the system to this excitation. The operation of technical systems creates disruptive processes, the consequence of which are complex temporal functions of disruptive forces. The technical system can be sensitive to a certain type of excitement or not, i.e. excitation may or may not lead to vibrations [5, 6].

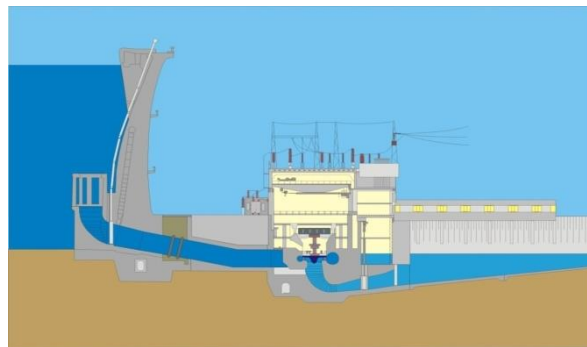
Since vibrations are an undesirable phenomenon, during construction it is necessary to set the ratio of excitation and sensitivity of the system to excitation so that the vibration level is as low as possible. In addition, vibrations lead to additional dynamic loads that contribute to the reduction of load capacity and working properties, accelerated fatigue, etc.[7, 8]

For experimental testing, modern sensors (receptors, detectors) were used, which convert each mechanical quantity into an electrical signal and send it to the central memory. Software accepts, compares and sends all analog/digital converters to executive bodies (servomotors and reactors) that accept the signal from the memory unit and take the position regulating the required parameter [9-12].

## MATERIAL AND METHODS

The main tests were carried out at the "Bočac" Hydroelectric power plant (Figure 1), whose basic characteristics are: Type of turbine – "Francis" vertical, nominal turbine power 2 x 57.6 MW, nominal degree of utility  $\eta = 94.5\%$ , diameter of the impeller 4050 mm, masa radnog kola 23,58 t weight of the impeller 23.58 t, mass of the shaft 37.4 t, nominal speed 150 rpm, speed at escape 322 rpm.

The turbine shaft is directly connected to the synchronous generator, the technical characteristics of which are: generator power 2 x 65 MVA, generator voltage is 10.5kV, 50Hz, nominal current 3574 A, nominal efficiency  $\eta = 98\%$ , stator mass 200 t, rotor mass 150 t, excitation type - static, nominal excitation parameters: 206V, 1225 A, power factor –  $\cos \phi = 0.85$  [13].



*Fig. 1. Cross-section of the "Bočac" Hydroelectric power plants*

### Vibration analysis

The overall vibration level, regardless of whether the amplitude of vibration displacement, vibration speed or vibration acceleration is measured, is an indicator of the intensity of the disruptive force and the seriousness of the problem. It gives an indication of the amount of vibration energy that is contained between two specific frequencies.

Depending on the characteristics of vibration sensors, amplitudes of vibration displacement can be measured using non-contact sensors that work on the principle of eddy currents, vibration speed using inductive sensors and vibration acceleration using accelerometers [2, 7].

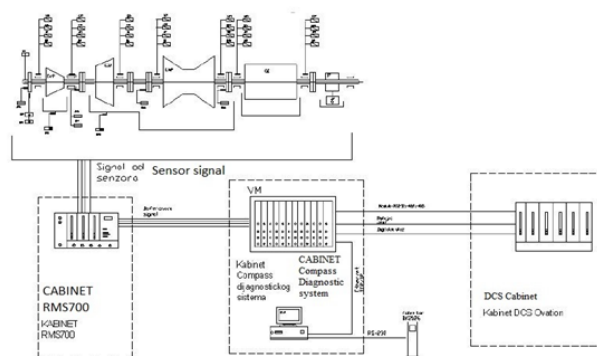
The vibration analysis was done during the condition monitoring period and was done in correlation with the process parameters and temperature analysis. The diagnostic analysis of the state of the aggregate was done on the basis of measurement results recorded by the installed on-line monitoring system COMPASS and analysis of measurement data. Analyzes were performed with portable diagnostic equipment, with specially developed diagnostic bases, for those measurements that are not included in the COMPASS system, and which are provided for according to the ISO 10816 standard.

COMPASS (Computerised Predictive Analysis and Safety) is a computer-controlled vibrodiagnostic system, which serves to monitor the mechanical condition of rotary machines and predict potential machine failures PFM (Potential Failure Mode) (Figure 2). It consists of a VM monitor and a CVM computer system. The function of the VM monitor is to execute the monitoring strategy and implementation in the on-line COMPASS database. Distributive digital signal processing provides real-time signal analysis.. CVM is an Intel microprocessor system based on the SCO UNIX platform, designed for Compass application packages and the Compass database. The Data Collector 2526/2526E is used to collect vibration and process data in the off-line COMPASS database. As part of the COMPASS diagnostic system, the ADVISOR expert system was also developed, which, in addition to the standard knowledge base, enables the user's knowledge base to be entered as well. All this contributes to the development of automated diagnostics.



Software modules can perform a wide range of functions for diagnostic purposes, such as: measurement of the total vibration level in parallel from all sensors, display of the trend of the overall vibration level, orbital display, Bode and Polar representation of individual harmonics, spectrum trend view, cascade spectral display, trend of X-Y shaft position, vibration components, etc.

A continuous vibration monitoring system is implemented when monitoring the vibration level with built-in additional relays that can signal the exceeding of a preset vibration level. The COMPASS vibration monitoring system, in addition to monitoring the level of vibrations on the bearings and the shaft, also monitors the phase angles of the vibrations in relation to the shaft, and has additional possibilities for monitoring the machine's process parameters. This type of monitoring system has the ability to analyze and condition signals and communicate with computers and expert systems. In addition to the protection function, it performs diagnostic analyzes on the basis of which the cause of vibrations is detected and measures are proposed for its elimination. This applies both to work in stationary conditions and to the measurement and analysis of vibrations during the start/stop of the machine.

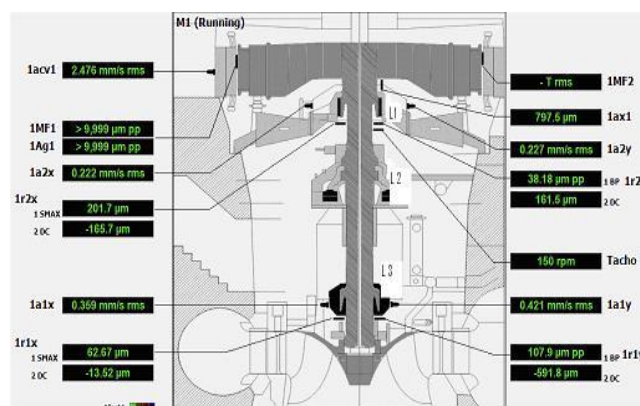


**Fig.2.** Schematic view of the installed COMPASS diagnostic system in the Hydroelectric power plant "Bočac"[13]

## RESULTS AND DISCUSSION

### Display of test results

Figure 3 shows the arrangement / disposition scheme of the plant



**Fig.3.** Dispositional scheme of measurements on Hydro unit No. 1 in the COMPASS system

The installed active power of the unit is 55 MW, the Francis turbine has 12 working wheels, the generator has 20 pairs of poles.

Process parameters in nominal operating mode: active power 55 MW, turbine rotation speed 150 rpm, excitation current 817A, excitation voltage 120V.



### Parameters of the dynamic state - Hydro aggregate No. 1 Bočac

Table 1 shows the absolute vibrations on the bearings of the Hydro aggregate (idle run)

Table 2 shows the absolute vibrations on the bearings of the Hydro unit (load 55MW)

Table 3 shows rotor vibrations (load 55MW)

**Table 1. Absolute vibrations on bearings of Hydro aggregates (idle run)**

Bear ing	Direction – x				Direction – y				Direction – z				
	$\sum V_{RM}$ [mm/s]	1X	2X	Fa z 1x	Faz 2x	$\sum V_{RM}$ [mm/s]	1X	2 X	Fa z 1x	$\sum V_R$ M [mm/s]	1x	2x	Faz 1x
L1	<b>0.83</b>	0.28	0.09	-	-	<b>1.10</b>	0.21	-	-	<b>1.16</b>	0.42	-	-
L2	<b>1.54</b>	0.42	0.08	-	-	<b>0.63</b>	0.55	-	-	<b>1.68</b>	0.50	-	-
L3	<b>0.47</b>	0.38	0.05	-	-	<b>0.28</b>	0.20	-	-	<b>0.61</b>	0.40	-	-

**Table 2. Absolute vibrations on Hydro aggregate bearings (load 55MW)**

Beari ng	Direction – x				Direction – y				Direction – z				
	$\sum V_R$ M [mm/s]	1X	2X	Faz 1x	Fa z 2x	$\sum V_{RM}$ [mm/s]	1X	2x	Faz 1x	$\sum V_{RM}$ [mm/s]	1x	2x	Faz 1x
L1	<b>1.17</b>	0.2	0.09	-	-	<b>1.11</b>	0.21	-	-	<b>0.84</b>	0.33	-	-
L2	<b>0.57</b>	0.4	0.08	-	-	<b>0.67</b>	0.35	-	-	<b>1.52</b>	0.30	-	-
L3	<b>0.41</b>	0.2	0.05	-	-	<b>0.33</b>	0.29	-	-	<b>0.40</b>	0.41	-	-

Note: The vibration level of stator packages is  $V_{rms} = 1.85$  mm/s

**Table 3. Rotor vibrations (load 55MW)**

Bear ing	Direction – x						Direction – y						$S_{max}$ [ $\mu/s$ ]
	$A_{p-p}$	1x	2x	Faz 1x	Faz 2x	7x	$A_{p-p}$	1x	2x	Faz 1x	Faz 2x	7x	
L1	<b>150</b>	240	3.5	-	-	-	<b>40.0</b>	25.0	-	-	-	-	<b>178.2</b>
L2	-	-	-	-	-	-	-	-	-	-	-	-	-
L3	<b>116</b>	102	14	-	-	-	<b>118</b>	95	8.1	-	-	-	<b>62.94</b>

### Parameters of the dynamic state - Hydro aggregate No. 2 Bočac

The arrangement scheme of the plant is the same as on unit 1.

Table 4 shows the absolute vibrations on the Hydro unit bearings (idle run)

Table 5 shows the absolute vibrations on the bearings of the Hydro unit (load 55MW)

Table 6 shows rotor vibrations (load 55MW)

**Table 4. Absolute vibrations on bearings of Hydro aggregates (idle run)**

Bearing	Direction – x				Direction – y				Direction – z			
	$\sum V_{RMS}$ [mm/s]	1X	2X	Faz 1x and 2x	$\sum V_{RMS}$ [mm/s]	1X	2X	Faz 1x and 2x	$\sum V_{RMS}$ [mm/s]	1x	2x	Faz 1x and 2x
L1	<b>0.46</b>	0.33	0.09	-	<b>0.48</b>	0.41	-	-	<b>0.55</b>	0.42	-	-
L2	<b>0.38</b>	0.41	0.08	-	<b>0.25</b>	0.15	-	-	<b>0.48</b>	0.30	-	-
L3	<b>0.57</b>	0.28	0.05	-	<b>0.28</b>	0.20	-	-	<b>0.61</b>	0.40	-	-

**Table 5. Absolute vibrations on Hydro aggregate bearings (load 55MW)**

Bearing	Pravac – x				Pravac – y				Pravac – z			
	$\sum V_{RMS}$ [mm/s]	1X	2X	Faz 1x and 2x	$\sum V_{RMS}$ [mm/s]	1X	2x	Faz 1x and 2x	$\sum V_{RMS}$ [mm/s]	1x	2x	Faz 1x and 2x
L1	<b>1.22</b>	0.20	0.09	-	<b>1.25</b>	0.25	-	-	<b>1.35</b>	0.30	-	-
L2	<b>1.31</b>	0.45	0.08	-	<b>1.29</b>	0.35	-	-	<b>0.61</b>	0.40	-	-
L3	<b>0.42</b>	0.20	0.05	-	<b>0.36</b>	0.19	-	-	<b>0.49</b>	0.31	-	-

**Table 6. Rotor vibrations (load 55MW)**

Bearing	Direction – x						Direction – y						S <sub>max</sub> [μm]
	A <sub>p-p</sub>	1x	2x	Faz 1x	Faz 2x	7x	A <sub>p-p</sub>	1x	2x	Faz 1x	Faz 2x	7x	
L1	<b>120</b>	149	40	-	-	-	<b>116</b>	100	40	-	-	-	<b>97.20</b>
L2	-	-	-	-	-	-	-	-	-	-	-	-	-
L3	<b>54.5</b>	74.4	18	-	-	-	<b>35</b>	22	15	-	-	-	<b>78.70</b>

Note: The vibration level of stator packages is  $V_{rms} = 1.85$  mm/s

Figure 4 shows the layout of the magnetic flux on Hydro unit No. 1

Figure 5 shows the analysis of the air gap on Hydro power unit No. 1



Fig.4. Distribution of magnetic flux on Hydro unit No. 1



Fig. 5. Analysis of the air gap on Hydro power unit No. 1

Figures 4 and 5 show the arrangement of the magnetic flux and the size of the air gap, on the generator on the Hydro unit No. 1. After analyzing the value of the air gap, it can be seen that it is evenly distributed and has a very small asymmetry of the magnetic field.

### Condition assessment - Hydro power unit No. 1 "Bočac"

Tables 1 and 2 show that the highest value of absolute vibrations is  $L1 = 1.17 \text{ mm/s}$  under a load of 55MW and  $L2 = 1.68 \text{ mm/s}$  neutral, it exceeds zone A but is at the beginning of zone B (according to ISO 10816-5 zone A is 1.6 according to VDI 1.8 and zone B is 2.5), the condition of the Unit is declared as good.

Based on the evaluation of rotor vibrations from Table 3, it can be seen that the level of  $S_{\max}$  measured at  $L1 = 178.2 \text{ } \mu\text{m}$ , that in relation to the ISO 7919 standard, the limit A is  $85 \text{ } \mu\text{m}$  and the limit B is  $220 \text{ } \mu\text{m}$  exceeds the limit A, but does not exceed the limit B, so it belongs to area B.

The condition of Hydro power unit No. 1 is declared as: GOOD, i.e. acceptable for continuous long-term operation. Based on the ISO 7919 standard, which evaluates the condition of the machine / unit on the basis of rotor vibrations, the condition of the Hydro power unit is in class B and is evaluated as acceptable for uninterrupted long-term operation. During the review of the COMPASS diagnostic system, warning alarms were present: from absolute vibration measurement 2a2x and shutdown alarm from measurement 1a1x, which is shown in the pictures.

The analysis of the measurements clearly shows that the alarm from measurement 2a2x lasted only a few seconds and that there were no noticeable changes in the other sensors during that period, which leads to the conclusion that this is a consequence of the current excitation of the sensor itself, and not a consequence of the existence of malfunctions in the operation of the Hydro power unit. Alarm 1a1x lasted for 4 hours and was also repeated in the previous system status monitoring. During that period, the other sensors did not record

any change in state, which indicates that the measurement of that sensor was incorrect during that period. In this case, most likely, it is about inadequate placement of the sensor itself, so there is an unreliability of this measurement. Certainly, the system should continue to be monitored continuously. If there is a major change in dynamic behavior, greater than 25%, a deeper diagnostic analysis should be performed.

Figure 6 shows the measurement of the vibration level from the turbine bearing on Hydropower unit No.1

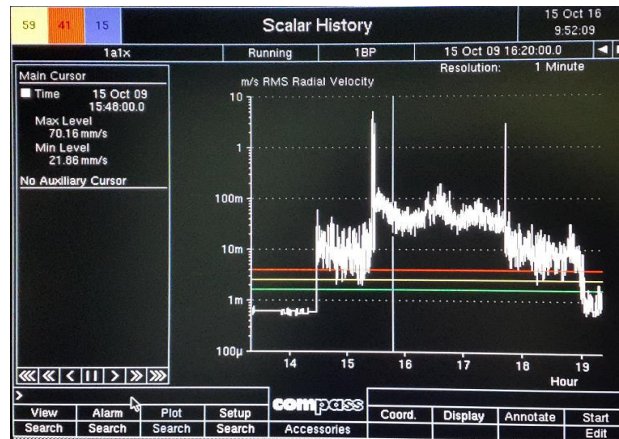


Fig. 6. Shows measurement of vibration level from the turbine bearing on Hydropower unit No. 1

### Condition assessment - Hydro power unit No. 2 "Bočac"

From table 5, the highest value of absolute vibrations is  $L1 = 1.35$  mm/s under a load of 55 MW, it does not exceed zone A (according to ISO 10816-5 zone A is 1.6 according to VDI 1.8), the condition of the machine - unit is declared as good.

Based on the evaluation of rotor vibrations from Table 6, it can be seen that the  $S_{max}$  level was measured at  $L1 = 97.20$  µm, that in relation to the ISO 7919 standard, limit A is 85 µm and limit B is 220 µm, it exceeds limit A and does not exceed limit B. means it belongs to area B.

The state of Hydro unit 2 is declared as: GOOD, that is, acceptable for continuous long-term operation. Based on the ISO 7919 standard, which evaluates the condition of the machine / Unit on the basis of rotor vibrations, the condition of the Hydraulic unit is in class A and is evaluated as acceptable for uninterrupted long-term operation.

### CONCLUSION

The conducted research can be applied to all other technical systems or elements where there is pronounced vibration due to the rotational movement of a machine element.

The results showed that the occurrence of vibrations is very harmful to the technical system, which indicates the need for structural improvement of technical systems in the initial phase of the life cycle and preventive elimination of the cause of vibrations..

By monitoring the vibrations, it is possible to see up to what limit values the components of the assemblies in the exploitation processes can have a correct and safe operation.

The results of the research show that the systems, which were the subject of the research, from the aspect of vibration analysis of technical systems, indicate that their maintenance keeps pace with new technological changes, due to which the degree of machine failure is reduced to a minimum, which positively affects the level of productivity of the entire production system.

## REFERENCES

- [1] El-Mongy, H. H., Younes, Y. K., Vibration analysis of a multi-fault transient rotor passing through sub-critical resonances, *Journal of vibration and control* 2018, 24 (14), 2986-3009, 2018. <https://doi.org/10.1177/1077546317697828>
- [2] Adamovic, Z., Josimovic, Lj., Vulovic, S., Ilic, B., Spasic, D., *Vibro-diagnostic Maintenance of Technical Systems*, Serbian Society for Technical Diagnostics, Belgrade, 2016.
- [3] Shengyuan, L., Longxi, Z., Vibration Attenuation Mechanism of the Rotor System with Anisotropic Support Stiffness, *Transactions of Famena* 2021, 45(1), pp. 129-144, 2021. <https://doi.org/10.21278/TOF.451017220>
- [4] Gunter, E., *Understanding Amplitude and Phase in Rotating Machinery*, University of Virginia, 2014.
- [5] Diewald, W., Nordmann R., Parameter optimization for the dynamics of rotating machinery, 3rd IFToMM Int. Conf. on Rotordynamics 1990, Lyon, France, pp. 51–55. 1990.
- [6] Zhang, G., Wu, J., Hao, L., Analysis on the Amplitude and Frequency Characteristics of the Rotor Unbalanced Magnetic Pull of a Multi-Pole Synchronous Generator with Inter-Turn Short Circuit of Field Windings, *Energies* 2018, 11(1), pp. 60-67, 2018. <https://doi.org/10.3390/en11010060>
- [7] Muszynska, A. *Vibrational Diagnostics of Rotating Machinery Malfunctions*, *International Journal of Rotating Machinery* 1995, 1(3-7), pp. 152-158. 1995. <https://doi.org/10.1155/S1023621X95000108>
- [8] Prvulovic, S., Tolmač, D., Dimitrijević, D., Tolmač, J., Research of sensibility and tendency rotors to unbalance, *Journal of the Balkan Tribological Association (JBTA)* 2012, 18(3), pp. 365–380, 2012.
- [9] Zhang, G., Qi, Q., Yu, Z., Shaft Vibration Monitoring System for Rotating Machinery, 6th International Conference on Instrumentation and Measurement, Computer, Communication and Control (IMCCC) , Harbin Inst Technol, Harbin, PEOPLES R CHINA, JUL 21-23, 2016, pp. 47-52, 2016. <https://doi.org/10.1109/IMCCC.2016.17>
- [10] Jurić, S., *MODELS OF RISK FOR ASSESSMENT OF VIBRATION LEVELS OF TECHNICAL SYSTEMS* , (doctoral dissertation), University in Novi Sad, 2018.
- [11] Thorsten, P., Philipp G., Florian, D., Jürgen, C., "Dynamic Rotor Deformation and Vibration Monitoring Using a Non-Incremental Laser Doppler Distance Sensor," 9th International Conference on Vibration Measurements by Laser and Noncontact Techniques and Short Course, Ancona, Italy Jun 22-25, 2010, vol.1253, pp. 361-370, 2010. <https://doi.org/10.1063/1.3455478>
- [12] Milovančević, M., Milenković, D., Troha, S., The optimization of the vibrodiagnostic method applied on turbo machines, *Transactions of Famena* 2009, 33(3), pp. 63-70, 2009.
- [13] Documentation of the "Bočac" hydropower plant.



## MACHINE LEARNING FOR PREDICTIVE MAINTENANCE IN INDUSTRY 4.0: CURRENT TRENDS AND CHALLENGES

**Dragan A. Milošević<sup>1</sup>, Dragoljub Ilić<sup>1</sup>, Miroslav Vulić<sup>1</sup>**

<sup>1</sup> University Business Academy in Novi Sad, Faculty of Economics and Engineering  
Management in Novi Sad, University Business Academy in Novi Sad, Serbia  
e-mail: [dragan.milosevic@fimek.edu.rs](mailto:dragan.milosevic@fimek.edu.rs)

**Abstract:** In the era of Industry 4.0, predictive maintenance stands as a critical pillar for efficient and cost-effective operations. This paper conducts a systematic literature review, synthesizing the current state of applying machine learning techniques to predictive maintenance. The study underscores the significance of predictive maintenance in Industry 4.0 and elucidates its potential to revolutionize maintenance practices. It delves into the challenges associated with data quality, model interpretability, and scalability, offering insights through real-world use cases. Additionally, the paper explores the integration of machine learning into Industry 4.0 and its role in sustainable smart manufacturing.

**Key words:** Predictive Maintenance, Machine Learning, Industry 4.0

### INTRODUCTION

Industry 4.0 has ushered in a transformative wave, where automation, connectivity, and data-driven decision-making redefine manufacturing and industry. Central to this shift is predictive maintenance, an approach aimed at minimizing downtime and optimizing asset performance through data, machine learning, and artificial intelligence. In the context of Industry 4.0, where the Internet of Things (IoT) and cyber-physical systems interconnect machines and processes, predictive maintenance assumes an increasingly pivotal role.

This paper aims to provide a concise yet thorough examination of the current trends and challenges of applying machine learning to predictive maintenance within the context of Industry 4.0. Predictive maintenance is not only a cost-saving measure but also a strategic imperative that ensures uninterrupted operations, enhances safety, and extends critical asset lifespans. Moreover, it aligns with Industry 4.0's overarching goals, such as sustainable and smart manufacturing practices.

As we navigate this paper's concise sections, we will embark on a journey through the existing literature, explore machine learning's intricacies in predictive maintenance, and delve into the evolving landscape of Industry 4.0. By shedding light on the latest developments and challenges in this domain, we aim to offer valuable insights to researchers, practitioners, and decision-makers seeking to harness the full potential of predictive maintenance in the Industry 4.0 era.

Predictive maintenance, as revealed in these succinct sections, is not merely a response to operational challenges but a harbinger of a new era in industrial efficiency, sustainability, and competitiveness. Through this condensed paper, we bridge the gap between theory and practice, providing a holistic perspective on machine learning's current state in predictive maintenance and paving the way for future advancements in this critical field.

### MACHINE LEARNING FOR PREDICTIVE MAINTENANCE

Predictive maintenance is a crucial paradigm within the realm of Industry 4.0, offering the potential to revolutionize maintenance practices across various sectors. This section explores the integral role of machine learning in enabling predictive maintenance strategies and delves into the diverse range of machine learning algorithms employed in this context.

## Concept of Predictive Maintenance

Predictive maintenance fundamentally entails the proactive identification of machinery and equipment failures before they occur. By harnessing data-driven insights, organizations can anticipate maintenance needs, schedule interventions optimally, and minimize costly downtime. Machine learning plays a pivotal role in this process by analyzing historical data, sensor readings, and other relevant information to forecast equipment degradation and failures accurately.

## Machine Learning's Role

Machine learning serves as the cornerstone of predictive maintenance by automating the analysis of vast datasets that would be impractical for human operators to process comprehensively. Various machine learning algorithms are leveraged, each suited to specific predictive maintenance tasks. These algorithms include but are not limited to:

- **Regression Analysis:** Used for predicting equipment lifespan and estimating when maintenance actions should be taken based on degradation trends.
- **Classification Algorithms:** Employed to categorize equipment health into predefined states such as 'normal,' 'warning,' or 'failure imminent.'
- **Clustering Algorithms:** Assist in grouping similar equipment based on operational characteristics, enabling tailored maintenance strategies.
- **Time Series Analysis:** Utilized to identify patterns and anomalies in sensor data, aiding in the detection of early signs of equipment deterioration.
- **Deep Learning:** Particularly effective in processing unstructured data, such as images or natural language, for predictive maintenance applications.

## Algorithmic Diversity

One notable feature of predictive maintenance in the context of machine learning is the diverse array of algorithms available. The choice of algorithm depends on factors like data type, volume, and the specific maintenance task at hand. Organizations may opt for regression algorithms when dealing with continuous data, whereas classification algorithms are suitable for identifying equipment states. Clustering algorithms, on the other hand, enable the grouping of similar machinery for customized maintenance plans.

Furthermore, deep learning techniques, such as convolutional neural networks (CNNs) and recurrent neural networks (RNNs), have shown remarkable promise in handling complex data sources like images and time series data. These techniques enhance the accuracy and reliability of predictive maintenance models, especially in scenarios where traditional algorithms may fall short.

Machine learning is at the forefront of predictive maintenance strategies in Industry 4.0. It empowers organizations to transition from traditional reactive maintenance approaches to proactive, data-driven practices. By embracing algorithmic diversity and harnessing the potential of deep learning, businesses can unlock significant cost savings, maximize equipment uptime, and bolster overall operational efficiency. The subsequent sections of this paper will delve deeper into the current trends, challenges, and real-world applications of machine learning-driven predictive maintenance.

## Limits and Challenges of Machine Learning

Despite its remarkable capabilities, machine learning is not without limitations and challenges. It heavily relies on the availability of high-quality and labeled data for training, which can be a bottleneck in some applications. Model interpretability remains a challenge, especially in deep learning, where complex networks can act as "black boxes." Ethical



considerations, such as bias in algorithms, privacy concerns, and data security, also pose significant challenges. Moreover, ensuring the robustness and reliability of machine learning models in real-world scenarios remains an ongoing research area.

## LITERATURE REVIEW

Predictive maintenance (PdM) is crucial in Industry 4.0, where digital and physical systems converge to generate data, allowing for data-driven insights and cost reduction [1]. PdM relies on machine learning (ML) techniques, such as the approach by Susto et al. [2], which introduces multiple classifiers for versatile maintenance management [2]. This method optimizes maintenance schedules based on cost-effectiveness, especially in semiconductor manufacturing [2].

Another study by Paolanti et al. [3] highlights the effectiveness of Random Forest in predicting equipment conditions, demonstrating the potential of ML in predictive maintenance within Industry 4.0 [3]. Reference [4] emphasizes the benefits of integrating data from diverse sources and using ML for predictive maintenance in Industry 4.0 [4].

Gohel et al. [5] propose an ML-based approach, specifically SVM and logistic regression, for predictive maintenance in nuclear infrastructure, focusing on handling massive sensor data to improve plant efficiency [5]. They find SVM to be superior in this context [5].

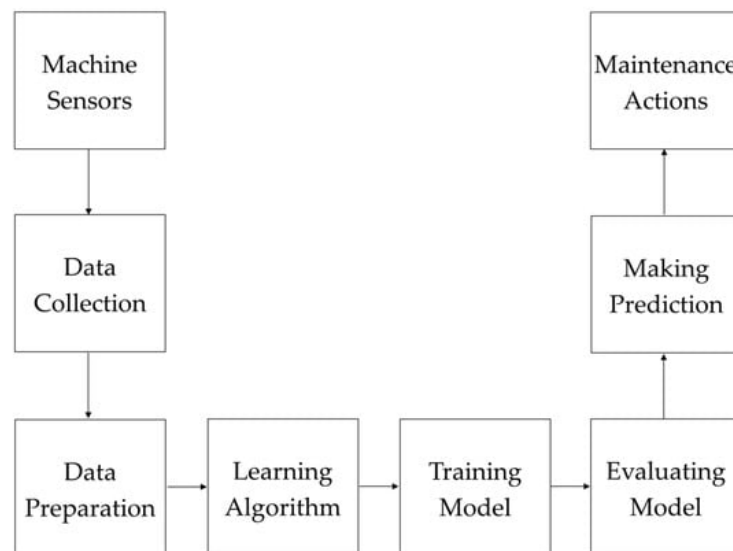
IoT integration in manufacturing has led to real-time predictive maintenance systems [6], utilizing ML techniques like Random Forest and XGBoost to detect potential failures early and reduce production stoppages [6].

PdM within Industry 4.0 relies on ML for handling large datasets and optimizing maintenance strategies [7]. RF, SVM, and ANN are commonly used ML algorithms [7]. A comparative study identifies Random Forest and Decision Trees as effective in predictive maintenance [8].

In food and agriculture, ML aids in optimizing supply chains, predicting maintenance needs, detecting crop diseases, and more [9]. The integration of AI and ML enhances efficiency and sustainability [10].

Reference [11] introduces a Decision Support System (DSS) that emphasizes feature extraction and ML prediction models for PdM, offering real-time decision-making in a cloud-based architecture [11]. Reference [12] presents Balanced K-Star, an ML method designed for imbalanced PdM datasets in IoT-enabled manufacturing, improving classification accuracy [12].

Figure 1 illustrates the overarching structure of the proposed predictive model, as detailed in reference [12].



**Fig. 1.** The general structure of the proposed predictive model [12]

PdM in Industry 4.0 relies on ML for data-driven insights, cost reduction, and efficient maintenance scheduling. Various ML algorithms and approaches cater to different industrial contexts, offering promising prospects for enhancing predictive maintenance. [8]

## **CURRENT TRENDS IN INDUSTRY 4.0**

Industry 4.0 represents a transformative era characterized by the convergence of digital technologies, automation, and data-driven decision-making. As we delve into the current trends in Industry 4.0, it becomes apparent that this paradigm shift is reshaping maintenance practices across industries in unprecedented ways.

### **Characteristics of Industry 4.0**

Industry 4.0 is marked by several key attributes. Firstly, it emphasizes the interconnectedness of systems, where machines, sensors, and devices communicate and collaborate autonomously through the Internet of Things (IoT). Secondly, it leverages big data analytics to extract actionable insights from the massive amounts of data generated within manufacturing processes. This data-driven approach enables predictive and prescriptive maintenance, allowing organizations to preempt equipment failures and optimize maintenance schedules. Thirdly, Industry 4.0 promotes the use of cyber-physical systems (CPS), where physical processes are seamlessly integrated with digital counterparts, enhancing real-time monitoring and control.

### **Transformation of Maintenance Practices**

The integration of Industry 4.0 technologies is revolutionizing maintenance practices. Traditional, reactive maintenance is gradually giving way to predictive and condition-based maintenance strategies. By continuously monitoring equipment through sensors and collecting data, organizations can predict when maintenance is required, preventing costly breakdowns and minimizing downtime. Furthermore, augmented reality (AR) and virtual reality (VR) are enhancing maintenance processes by providing technicians with immersive training and remote assistance, reducing response times.

### **Integration of Machine Learning**

Machine learning is at the heart of Industry 4.0's impact on maintenance. It enables the development of predictive maintenance models capable of forecasting equipment failures with high accuracy. Additionally, machine learning algorithms process sensor data in real-time, identifying anomalies and triggering maintenance alerts. Explainable AI techniques are emerging, providing insights into how these models make decisions, addressing concerns about model interpretability.

Industry 4.0 is ushering in a new era of maintenance practices characterized by proactive, data-driven, and technologically augmented approaches. As organizations continue to embrace these trends, they are poised to unlock significant efficiency gains, cost savings, and improved asset reliability within the dynamic landscape of Industry 4.0.

## **CHALLENGES IN IMPLEMENTING PREDICTIVE MAINTENANCE**

Predictive maintenance, while holding immense promise, is not without its share of formidable challenges that must be navigated for successful implementation, especially when coupled with machine learning. These challenges arise from the complex interplay between data, algorithms, and real-world industrial contexts. Below, we delve into the primary hurdles that organizations encounter on their journey to implement predictive maintenance with machine learning:

1. **Data Quality:** The foundation of predictive maintenance lies in data. To build accurate and reliable models, organizations must contend with issues of data quality. Inconsistent or noisy data, data gaps, and sensor inaccuracies can mislead machine learning algorithms, leading to incorrect predictions. Ensuring high-quality data acquisition and preprocessing remains a critical challenge.
2. **Model Interpretability:** While machine learning models exhibit impressive predictive capabilities, they often function as "black boxes." Understanding why a model makes a particular prediction can be elusive. In industries where interpretability is crucial for decision-makers and regulatory compliance, this challenge becomes paramount. Developing interpretable machine learning models that maintain predictive accuracy is an ongoing area of research.
3. **Scalability:** Implementing predictive maintenance across an entire industrial facility or fleet of machines poses scalability challenges. As data volumes grow, so does the computational load for training and deploying machine learning models. Efficiently scaling predictive maintenance solutions to accommodate large-scale operations without sacrificing performance is a significant technical challenge.
4. **Data Integration:** In Industry 4.0 environments, data streams from various sources need to be integrated seamlessly. This includes data from IoT sensors, legacy systems, and disparate machinery. Ensuring that these diverse data sources can be harmonized and used effectively for predictive maintenance is a complex undertaking.
5. **Expertise Gap:** Successfully implementing predictive maintenance requires a workforce with expertise in both domain-specific knowledge and machine learning. Bridging the gap between domain experts and data scientists is a challenge, as it necessitates multidisciplinary collaboration and knowledge sharing.

## DISCUSSION

The findings presented in this paper underscore the transformative potential of deep learning-based image processing using TensorFlow in the domain of transportation. Through a review of prior studies and case examples, we've explored the capabilities of TensorFlow in addressing critical traffic safety and efficiency challenges.

The utilization of Convolutional Neural Networks (CNNs) for image classification has demonstrated remarkable accuracy in recognizing vehicles involved in accidents, aiding in a precise understanding of accident scenarios. However, we acknowledge that image preprocessing techniques may require further refinement to enhance performance in challenging conditions.

Automatic Number Plate Recognition (ANPR) systems, as discussed, play a pivotal role in modern traffic management, but they are not without limitations. The advancement of OCR technology, such as EasyOCR, presents a promising avenue for automation while addressing challenges like motion blur and obscured plates.

The research [9] on fault injection in TensorFlow-based applications sheds light on the importance of resilience in safety-critical systems. This work highlights the significance of understanding application resilience and its implications for safety.

Furthermore, the automated detection of in-car abandoned children through CNNs represents a critical contribution to vehicle safety. Such technology has the potential to save lives and prevent tragic incidents.

Traffic sign recognition using TensorFlow and MatLab offers real-time solutions for self-driving vehicles, ensuring safer and more efficient operations on the road. The adaptability of these models to varying conditions is a crucial factor in their effectiveness.

Intelligent traffic monitoring systems, integrating deep learning and image processing, hold significant promise for optimizing traffic flow and guiding drivers. The cost-effectiveness and scalability of these solutions make them invaluable for modern traffic management.

## CONCLUSION

The paper has shed light on the pivotal role of machine learning in predictive maintenance within the context of Industry 4.0. It is evident that predictive maintenance is not merely an operational necessity but a transformative force that empowers industries to optimize assets, minimize downtime, and achieve sustainability goals.

As we navigate the intricate landscape of data science, machine learning algorithms, and industrial processes, it becomes clear that predictive maintenance is not just a response to challenges; it is the harbinger of a new era in industrial efficiency, sustainability, and competitiveness.

In the digital age, where data is the lifeblood of innovation, machine learning stands as the catalyst that fuels predictive maintenance's evolution. By bridging the gap between theory and practice, this paper has offered a comprehensive perspective on the current state of machine learning for predictive maintenance.

As we move forward, embracing explainable AI, edge computing, autonomous maintenance, hybrid models, and comprehensive ecosystems, we are poised to unlock even greater potential. The future of predictive maintenance in Industry 4.0 promises to be marked by precision, efficiency, and a commitment to a sustainable and connected world. Through collaborative efforts among researchers, practitioners, and decision-makers, we can turn this vision into reality, propelling industries to new heights of performance and reliability.

## FUTURE DIRECTIONS

The future of predictive maintenance in Industry 4.0 holds immense promise, driven by continuous advancements in machine learning and the ever-expanding scope of digitalization. As we gaze ahead, several key trends and directions emerge:

1. Explainable AI (XAI): Developing machine learning models that are not only accurate but also interpretable is paramount. Future research will focus on creating AI systems that provide transparent insights into their decision-making processes, enhancing trust and facilitating human-machine collaboration.
2. Edge Computing: With the proliferation of IoT devices, edge computing will gain prominence. It allows for real-time data processing and decision-making at the edge of the network, reducing latency and ensuring rapid response for critical maintenance tasks.
3. Autonomous Maintenance: The integration of robotics and AI will enable autonomous maintenance systems. Robots equipped with sensors and AI algorithms will conduct routine inspections, identify issues, and perform maintenance tasks, reducing the need for human intervention.
4. Hybrid Models: Future predictive maintenance systems will likely rely on hybrid models that combine physics-based models with data-driven machine learning approaches. This synergy will enhance the accuracy and robustness of predictions.
5. Predictive Analytics Ecosystems: Building comprehensive predictive maintenance ecosystems will become crucial. This includes integrating data sources, analytics tools, and maintenance management systems to create end-to-end solutions.

## REFERENCES

- [1] T. P. Carvalho, F. A. A. M. N. Soares, R. Vita, R. da P. Francisco, J. P. Basto, S. G. S. Alcalá, "A systematic literature review of machine learning methods applied to predictive maintenance," *Computers & Industrial Engineering*, Volume 137, November 2019, 106024. DOI: <https://doi.org/10.1016/j.cie.2019.106024>.
- [2] G. A. Susto, A. Schirru, S. Pampuri, S. McLoone, and A. Beghi, "Machine Learning for Predictive Maintenance: a Multiple Classifier Approach," *IEEE Transactions on Industrial Informatics*, vol. 11, no. 3, pp. 812-820, 2015.

- [3] M. Paolanti, L. Romeo, A. Felicetti, A. Mancini, E. Frontoni, and J. Loncarski, "Machine Learning approach for Predictive Maintenance in Industry 4.0," in 2018 14th IEEE/ASME International Conference on Mechatronic and Embedded Systems and Applications (MESA), Oulu, Finland, 02-04 July 2018. doi: 10.1109/MESA.2018.8449150.
- [4] J. Dalzochio, R. Kunst, E. Pignaton, A. Binotto, S. Sanyal, J. Favilla, and J. Barbosa, "Machine learning and reasoning for predictive maintenance in Industry 4.0: Current status and challenges," *Computers in Industry*, vol. 123, p. 103298, Dec. 2020. [Online]. Available: <https://doi.org/10.1016/j.compind.2020.103298>.
- [5] H. A. Gohel, H. Upadhyay, L. Lagos, K. Cooper, and A. Sanzetenea, "Predictive maintenance architecture development for nuclear infrastructure using machine learning," *Nuclear Engineering and Technology*, vol. 52, no. 7, pp. 1436-1442, July 2020, doi: 10.1016/j.net.2019.12.029.
- [6] S. Ayvaz and K. Alpay, "Predictive maintenance system for production lines in manufacturing: A machine learning approach using IoT data in real-time," *Expert Systems with Applications*, vol. 173, July 2021, 114598.
- [7] Z. M. Çınar, A. A. Nuhu, Q. Zeeshan, O. Korhan, M. Asmael, and B. Safaei, "Machine Learning in Predictive Maintenance towards Sustainable Smart Manufacturing in Industry 4.0," *Sustainability*, vol. 12, no. 19, p. 8211, Oct. 2020. [Online]. Available: <https://doi.org/10.3390/su12198211>.
- [8] A. Ouadah, L. Zemmouchi-Ghomari, and N. Salhi, "Selecting an appropriate supervised machine learning algorithm for predictive maintenance," *The International Journal of Advanced Manufacturing Technology*, vol. 119, pp. 4277-4301, Jan. 2022.
- [9] H. Pallathadka, M. Jawarneh, F. Sammy, V. Garchar, D. T. Sanchez, and M. Naved, "A Review of Using Artificial Intelligence and Machine Learning in Food and Agriculture Industry," in 2022 2nd International Conference on Advance Computing and Innovative Technologies in Engineering (ICACITE), Greater Noida, India, 2022, pp. 635.
- [10] Ouadah, A., Zemmouchi-Ghomari, L. & Salhi, N. Selecting an appropriate supervised machine learning algorithm for predictive maintenance. *Int J Adv Manuf Technol* 119, 4277–4301 (2022). <https://doi.org/10.1007/s00170-021-08551-9>.
- [11] R. Rosati, L. Romeo, G. Cecchini, F. Tonetto, P. Viti, A. Mancini, & E. Frontoni, "From knowledge-based to big data analytic model: a novel IoT and machine learning based decision support system for predictive maintenance in Industry 4.0," *Journal of Intelligent Manufacturing*, vol. 34, pp. 107–121, 2023. [Online]. Available: <https://doi.org/10.1007/s10845-022-01960-x>.
- [12] Ghasemkhani B, Aktas O, Birant D. Balanced K-Star: An Explainable Machine Learning Method for Internet-of-Things-Enabled Predictive Maintenance in Manufacturing. *Machines*. 2023; 11(3):322. <https://doi.org/10.3390/machines11030322>.



## **SURFACE ROUGHNESS OPTIMIZATION IN LASER CUTTING BY USING TAGUCHI METHOD**

**Tamara Šajnović<sup>1</sup>, Dragan Rodić<sup>2</sup>, Marin Gostimirović<sup>2</sup>, Dejan Lukić<sup>2</sup>, Mijodrag Milošević<sup>2</sup>**

<sup>1</sup>University of Novi Sad, Technical Faculty "Mihajlo Pupin", Zrenjanin, Serbia

<sup>2</sup>University of Novi Sad, Faculty of Technical Sciences, 21000 Novi Sad, Republic of Serbia

e-mail: [tamarasajnovic15@gmail.com](mailto:tamarasajnovic15@gmail.com)

**Abstract:** In modern industry, laser machining is becoming an inevitable process in every company. Especially in the field of cutting thin sheets with complex contours. A very common problem in industry is to determine the machining parameters that provide optimal values for machining quality. In this study, surface roughness was determined using input parameters such as cutting speed, laser power and auxiliary gas pressure. The Taguchi method was used to determine the optimum values of the parameters that give the best surface roughness. By applying the smaller is better rule and the S/N values obtained, the optimum combination of machining parameters was determined. That is, a cutting speed of 3000 mm/min, a laser power of 1 kW and an auxiliary gas pressure of 0.5 bar.

**Key words:** laser machining, cutting speed, power, gas pressure, Taguchi method

### **INTRODUCTION**

Laser cutting represents a revolutionary technique in the realm of material processing, allowing for a high degree of precision and efficiency. Thanks to the concentrated energy of laser light, various materials can be processed quickly and accurately, whether in terms of cutting or engraving. Deciding on parameters such as laser power, speed and type of assist gas is of paramount importance for the end quality. Incorrect parameters can result in material damage or unreliable outcomes [1].

For example, fiber laser processing offers high-quality processing that meets even the strictest standards [2]. Such processing depends on numerous parameters, including the selection and positioning of nozzles or jets, which can be susceptible to damage if not properly positioned. The geometry and depth of the cut can also vary significantly depending on the parameters used.

For the best results, it's crucial to know the machine and its operating parameters. The quality of the cut depends on various factors, taking into account details such as the cleanliness and correctness of the laser lens, adequate flow of assist gas and the proper cutting speed [1]. When all these aspects are properly aligned and the machine is maintained in optimal condition, exceptional processing quality can be achieved.

### **MATERIAL AND METHODS**

Material cutting was carried out on the laser machine "Bystar 3015", known in the industry for its precision and efficiency. The machine operates based on fiber technology, which differs from the traditional technology of directing the laser through mirrors to the melting point. Instead, this technology operates on the principle of reflecting beams off the walls within the optical fiber [3].

Experiments were conducted on hot-rolled low-carbon steel sheet, commonly known in practice as black sheet, labeled SRPS EN 10130:2011. Cold-rolled low-carbon steel sheets are suitable for welding and applying coatings (metal coatings, painting) [4]. They are used on the automotive industry, white goods manufacturing, metallurgy and packaging. Additionally,

they find applications in numerous sectors of industry and construction, including machinery production, vehicle manufacturing, structural engineering, shipbuilding, industrial equipment production and metalworking [5].



**Fig. 1.** Appearance of the sample after cutting

Due to the complexity of the laser cutting process, many different factors can influence the quality of the cut [6, 7]. Based on information from the literature and the machine operator's experience, the following important parameters were identified: laser power, cutting speed and assist gas pressure [7, 8]. When selecting values for these parameters, manufacturer recommendations, machine limitations and characteristics of the material being cut were taken into account. As it is assumed that there are complex and nonlinear relationships between input parameters and cut characteristics, three levels of variation were chosen for each input factor, with the condition that a complete cut of the 3 mm thick sample material is achieved at each combination.

**Table 1.** Process factors by levels

Process factors	Unit	Level		
		1	2	3
Cutting speed, Vf	(m/min)	3000	3400	3800
Laser power, PI	(kW)	1	1.5	2
Assist gas pressure, P	(bar)	0.5	0.7	1.0

The process will be carried out on nine samples with varying parameters: cutting speed, laser power and assist gas pressure. Before starting, the machine must be thoroughly checked, including gas flow, cooling and the condition of the lens. After the check, the machine setup for processing follows. The machine is connected to a control screen with an operating system, allowing for visualization of the model and optimization of the workflow. The goal is to achieve maximum material utilization [9].

To investigate the impact of input factors on the cut quality, a measurement and quantification of the cut surface roughness were performed. The surface roughness was assessed using the average arithmetic deviation of the profile, Ra. Measurements were carried out using the Mitutoyo Surfest SJ-210 instrument, which operates based on dragging a measuring stylus across the cut surface and detecting irregularities.

These results can be easily processed and categorized by connecting the device to a computer.

The machine consists of a clamp for securing the material, the basic structure of the machine, a measuring column and a device with a measuring stylus.

The following image shows the appearance of the results for the first sample loaded into the software on the computer.



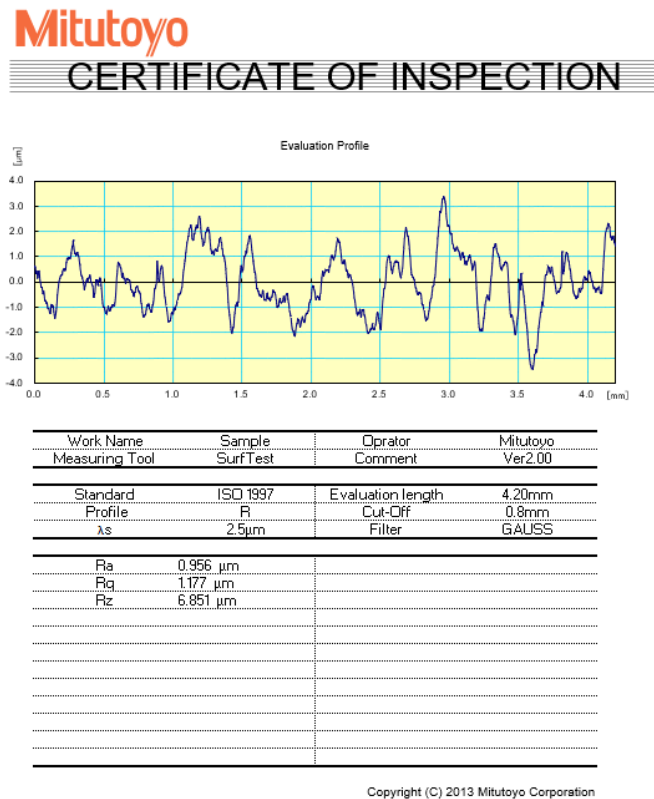


Fig. 2. Example of measurement results for Experiment 4

The Taguchi method, which was applied in this study, named after the Japanese engineer-statistician Dr Genichi Taguchi, is used for optimizing product design and work processes to enhance quality and reduce costs. It focuses on adjusting quality parameters around nominal values. This method gained significant expansion in the 1970s and 1980s because it integrates statistical methods into engineering processes, making it one of the key tools for quality planning today [9].

## RESULTS AND DISCUSSION

Japanese scientist Genichi Taguchi advanced the concept of experimental design through an optimization approach, dividing the problem into two categories. This approach uses the signal-to-noise (S/N) ratio as the target optimization function. There are three approaches to static optimization: smaller is better, larger is better and nominal is better. In the study, the primary goal was to minimize all output performances, using the "smaller is better" method according to the given equation 1:

$$(S/N)_j = -10 \log \frac{1}{n} \sum_{i=1}^n [y_{ij}^2], j = 1 \dots m \quad (1)$$

In the study, the Taguchi method was used for single- objective optimization of laser cutting input parameters, analyzing the output performances. This method offers a simple and systematically efficient approach to optimization, not requiring a mathematical model [10]. As an optimization tool, the Taguchi orthogonal array  $L_9(3^4)$  was applied to the laser cutting of 3 mm thick black sheet [9]. Table 2 presents the systematized parameters such as laser power, cutting speed and assist gas pressure that were varied to investigate their influence on the cut quality. Analyses were carried out using Minitab 17 software, where the optimization results displayed the impact of input factors with a 95% confidence interval.

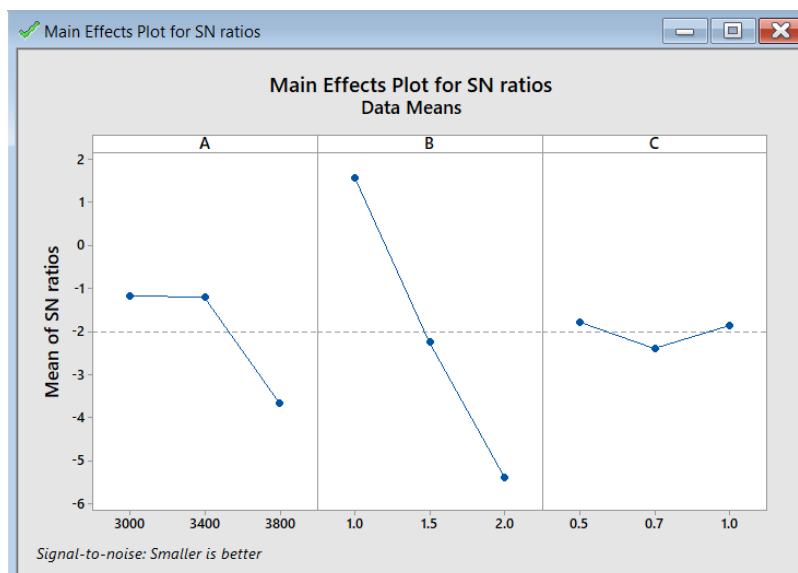
**Table 2.** Taguchi L9 orthogonal array experimental design and measurement results

No.	Factor			Ra
	Vf (mm/min)	PI (kW)	P (bar)	
1.	3000	1	0.5	0.683
2.	3000	1.5	0.7	1.102
3.	3000	2	1.0	1.426
4.	3400	1	0.7	0.956
5.	3400	1.5	1.0	1.498
6.	3400	2	0.5	1.480
7.	3800	1	1.0	0.888
8.	3800	1.5	0.5	1.311
9.	3800	2	0.7	3.052

In accordance with Table 2. and using Minitab software, the effects of the laser cutting process input parameters on the S/N values for the average arithmetic cut roughness were analyzed. The obtained results were first presented in a tabular form in Table 3. and then in the form of main effects plots.

**Table 3.** S/N values for factors related to the surface roughness.

Serial number	Factors	S/N ratio			max-min	Rank
		Levels				
		1	2	3		
1.	C1- Cutting speed, Vf	-1.178	-1.201	-3.671	2.492	2
2.	C2- Laser power, PI	1.578	-2.235	-5.393	6.971	1
3.	C3- Assist gas pressure, P	-1.789	-2.408	-1.854	0.619	3



**Fig. 3.** Main effects plot for S/N ratio values of factors related to the surface roughness

Based on the results from Table 3 and Figure 3, it can be concluded that the optimal combination of factor levels that minimizes the average arithmetic roughness of the cut is approximately at the minimum value C1 (level 1), C2 (level 1), C3 (level 1), Table 4. For the final verification of the results, it is necessary to perform a verification experiment in which the parameters of the laser are adjusted to the optimal level. In this case, this would be the first stage after which the surface roughness is measured again. In this case, this is not necessary because the parameters were set to the optimal level during the experimental test. It can be

concluded that the values of the measured and the optimum surface roughness are not very different.

**Table 4.** Optimal settings of input factors for surface roughness

Input parameters	Level	Adjust	Predicted
C1 Cutting speed, Vf	1	3000	S/N= 2,64 Ra= 0.498
C2 Laser power, PI	1	1.0	
C3 Assist gas pressure, P	1	0.5	

## CONCLUSION

In a modern industrial environment, conventional processing methods are often inadequate for specific and complex materials, highlighting the advantage of laser processing. Through this study, the importance of properly adjusting laser parameters such as its power, cutting speed and assist gas pressure to achieve optimal processing quality has been highlighted. Using the Taguchi method, the efficacy of optimizing input parameters for laser cutting to enhance output performances has been demonstrated. Data analyses, with the help of Minitab 17 software, pointed out the key factors influencing the cut quality. Based on the results, the optimal combination of factors to reduce the average arithmetic roughness of the cut is approximately: C1 at level 1, C2 at level 1 and C3 at level 1. This corresponds to a power of 1kW, speed of 3000 m/min and pressure of 0.5 bar. Taking all of this into account, it can be concluded that laser processing, with continuous optimization, has significant potential to meet the changing industrial demands.

**Acknowledgement:** This paper is part of a study in the project "Innovative scientific and artistic research from the FTS domain", No. 451-03-47/2023-01/200156, supported by the Ministry of Science, Technological Development and Innovation of the Republic of Serbia.

## REFERENCES

- [1] M. Gostimirović, Unconventional processing methods. Faculty of Technical Sciences, Novi Sad, 2012.
- [2] Jinan Bodor CNC Machine Co., Ltd: Fiber Laser Cutting Machine
- [3] Black, I., Livingstone, S.A.J., Chua, K.L.: Laser beam machining (LBM) database for the cutting of ceramic tile, Journal of Materials Processing Technology, Vol. 84, No. 1, pp. 47–55, 1998.
- [4] Cadorette, M.L., Walker, H.F.: Characterizing productivity of a 4 kW CO<sub>2</sub> laser cutting system for 0.25" mild steel using central composite methodology, Journal of Industrial Technology, Vol. 22, No.2, pp. 2-8, 2006.
- [5] Rajaram, N., Sheikh-Ahmad, J., Cheraghi, S.H.: CO<sub>2</sub> laser cut quality of 4130 steel, International Journal of Machine Tools and Manufacture, Vol. 43, No. 4, pp. 351–358, 2003.
- [6] Al-Sulaiman, F.A., Yilbas, B.S., Ahsan, M.: CO<sub>2</sub> laser cutting of a carbon/carbon multi-lamelled plain-weave structure, Journal of Materials Processing Technology, Vol. 173, No. 3, pp. 345–351, 2006.
- [7] Kovač, P., Krajny, Z., Šooš, Lj., Savković, B.: Overview of Material Processing Mechanisms in Unconventional Machining Methods, Journal of Production Engineering, Vol. 24, No. 1, pp. 1-9, 2021.
- [8] Stevan A. Simić, Zvonko S. Simić: Processing technology, 2016.
- [9] Miloš Madić: Mathematical modeling and optimization of the laser cutting process using artificial intelligence methods. Doctoral dissertation, 2013.
- [10] Alba, E., Chicano, F.: Genetic Algorithms in Alba, E., Martí, E. (Eds.), Metaheuristic Procedures for Training Neural Networks, Springer, pp. 109–138, 2006.



## RELIABILITY-BASED RISK ASSESSMENT OF AUXILIARY MACHINERY IN OPEN-PIT MINES: CASE STUDY OF A HYDRAULIC EXCAVATOR

Vesna Spasojević Brkić<sup>1</sup>, Nikola Petrović<sup>1</sup>, Uglješa Bugarić<sup>1</sup>

<sup>1</sup>University of Belgrade, Faculty of Mechanical Engineering, Belgrade, Serbia

e-mail: [ubugalic@mas.bg.ac.rs](mailto:ubugalic@mas.bg.ac.rs)

**Abstract:** Risk based approach has been proven in generating utility in the mining industry by multiple authors. However, most of the previous research has focused on heavy machinery, neglecting the impact that auxiliary machines have in overall risk management. The following study aims to propose a risk assessment methodology for auxiliary machinery in open-pit mines based on the analysis of a hydraulic excavator maintenance data. The overall risk was defined in accordance with the FMEA method, as a product of three partial indicators: severity, occurrence and detection of failures. Failure type distribution and distinction were illustrated via Pareto chart with the goal to rate the detection indicator. The chi-square tests of downtime and time between failure data were following and enabled analytical determination of the system's reliability and mean downtime, which led to evaluating the severity and occurrence of failures. Accordingly, framework for evaluation was proposed with a three dimensional risk assessment matrix as a result and proved on collected data.

**Key words:** risk, reliability, mining, hydraulic excavator

### INTRODUCTION

Every basic technological system places the most emphasis on the machines that perform the fundamental tasks of a system as a whole. As systems get more complex, the role of auxiliary equipment gets more important. That being said, most modern lignite open-pit mines are equipped with large machinery (rotor excavators and dredges, conveyors with rubber belts and dumpers), which perform basic technological processes (excavation, transport and disposal of overburden, i.e. excavation, transport, crushing or loading of useful substance). However, in order to even be able to engage with the fundamental process, there is a wide variety of auxiliary tasks that need to be done. In mining technology, the machines which are specialized for those kind of assignments are called auxiliary machinery. Adding to that, high-quality execution of auxiliary tasks is one of the most important preconditions for satisfactory time and capacity utilization in the open-pit mine. [1]

Although it may not be immediately apparent from a wide perspective, the effects of the auxiliary activities have a substantial impact on the end result. Among numerous of them, the following should be particularly highlighted: site plan development work, cleaning works, slope shaping, moving, extending, shortening, or transferring conveyors, construction and maintenance of access roads, plateaus, ramps, various embankments and cuttings, canals and water reservoirs for mine drainage, shaping of disposal areas at the technical phase of land recultivation, works in the domain of routine and investment maintenance of equipment, etc. [1].

The majority of auxiliary mechanization machines represent tools for digging and carrying dug material, which they do simultaneously. In other words, the movement of the working instrument is achieved by movement of the entire machine. Auxiliary machinery is contained of machines such as: dozers, loaders, pipelayers, rippers, hydraulic excavators, graders, scrapers, dragline excavators, rollers, cranes, trucks, tankers, off-road vehicles, etc. Some of the mentioned machines possess a wide range of application, i.e. they have a more universal character (dozers), while others are narrowly specialized for performing only certain types of work (cranes, drills) [1]. Dozers, pipelayers, and hydraulic excavators are the most significant and prevalent auxiliary machines in open-pit mines, excluding transport vehicles [2].

Maximum output in a mining system can only be achieved through maximum equipment utilization, as it operates 24 hours a day. Therefore, adequate reliability, maintainability characteristics and maintenance strategy are fundamental factors in unexpected breakdown and failure prevention. Not only that unexpected problems limit the machine's performance and effectiveness, but can also result in huge economic losses [3].

Having that in mind, the idea of managing risk in with the goal to minimize overall costs has arisen. In attempt to formulate a methodology that will tackle the problem properly, similar previous research has been reviewed at first. Eventually, the results will be discussed.

## LITERATURE REVIEW

Hydraulic excavators certainly represent one of the most important and common parts of every open-pit mine system [2]. Therefore, it isn't surprising that multiple studies have been done in order to to evaluate their reliability, availability and maintainability (RAM). A study by Kumar et al. [4] has shown the hydraulic excavator/shovel's failure rate and reliability, along with suggestions on how to improve overall capacity utilization by employing specifically timed preventive maintenance activities. It also illustrated the impact that the failure rate and reliability have on overall productivity of the mine. In order to determine of remaining useful life of an excavator, Ghomghaleh et al. [5] proposed a conceptual framework which relied on the reliability analysis in two classical and frailty models. Kumar et al. [6] analyzed failure and repair data, both graphically and statistically, with the goal to analytically determine RAM of shovel and dumper system at open-pit limestone mine. The Weibull distribution was chosen as the best fitting distribution using the K-S test. Liu et al. [7] have also done reliability analysis with the goal to identify the weakest component of a mechanical hydraulic system in excavators which will help in implementing appropriate maintenance strategies that are necessary for maintaining highly reliable systems. Numerous authors have suggested that failure risk assessment is a crucial extra prerequisite for developing an appropriate maintenance strategy, i.e. an effective plan for failure prevention. Spasojević Brkić et al. [8] analyzed results obtained in the excavator downtime analysis and proposed a risk assessment methodology. After the frequencies of downtime had been monitored by the defined categories of downtime, the consequences of the identified delays were evaluated and the risk was calculated. Velikanov et al. [9] sorted a variety of factors that can be the cause of a mining excavator to fail and calculated their frequencies. As they interpreted risk as the probability of failure, the most frequent factors were identified as those with the highest failure risk. Risk evaluation techniques that are more well-known have also been utilized, such as FMEA (Failure Mode and Effect Analysis) and FMECA (Failure Modes, Effects and Criticality Analysis) which were used in an attempt to develop an effective maintenance methodology of excavators in a study by Kumar & Kumar [10]. Despite the mentioned facts, literature review has shown a lack of work that has assessed failure risk based on RAM analysis. Therefore, the following study aims to evaluate failure risk in auxiliary machinery on an example of a hydraulic excavator ('excavator' in further text).

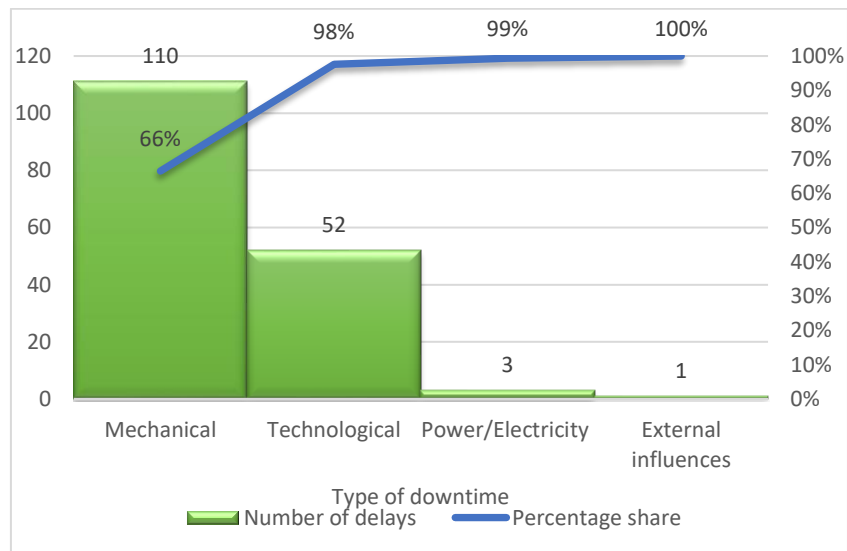
## METHODOLOGY

The main concept of this study can be separated in four different stages. The root of the analysis lies in recorded downtimes and times between failures, which represent the primary sample of an excavator's performance. Firstly, the gathered data must be analyzed and classified according to the type of downtime. Afterwards, downtimes and times between failures will be tested using a chi-square test in order to conclude which theoretical statistical distribution makes the best fit. The third stage of the study consists of establishing the reliability/unreliability functions. Depending the outcome of the statistical testing, the method of their determination shall be chosen. In other words, if the data can be approximated using an exponential theoretical distribution, mentioned functions can be determined analytically. Otherwise, other methods must be used, such as simulation, etc. Finally, three dimensional risk assessment model was proposed and overall excavator's risk has been evaluated.

## RESULTS AND DISCUSSION

### Data analysis and classification

Delays in the observed auxiliary machines were classified according to the type of downtime: mechanical downtime, technological downtime, power/electricity downtime and downtime due to external influences. In order to represent a distribution of failure types and identify which ones are most significant, a Pareto chart has been constructed (Figure 1).

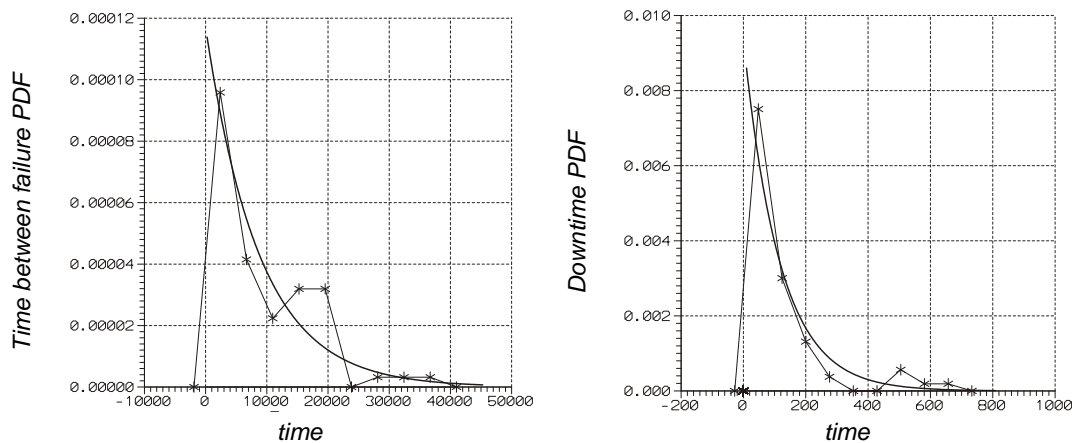


**Fig. 1.** Pareto chart of downtime types

As it can be seen in Figure 1, mechanical and technological delays represent an absolute majority with their 98% share in the whole sample. Therefore, from a maintenance and risk management perspective, the two types should be the most significant factors.

### Chi-square testing

The data was preprocessed into two samples – downtime and time between failures. Affiliation of the samples to the exponential theoretic distribution was established by applying chi-square test. Testing results showed that the time between failure could be described with the exponential distribution characterised by parameter  $\lambda = 0.0001138530$  with the relevance threshold of  $\alpha = 0,01$  (Figure 2). Exponential distribution parameter ( $\lambda$ ) will be equal to failure intensity  $\lambda_e = 0.0001138530 \text{ 1/min} = 0.00683118 \text{ 1/h}$ .



**Fig. 2.** Time between failure and downtime distribution

When it comes to downtime (repair time) sample, the results showed that the sample can be described with the exponential distribution characterised by parameter  $\lambda = 0.0085975507$  with the relevance threshold of  $\alpha = 0.01$  (Figure 2). Parameter of the distribution ( $\lambda$ ) will be equal to repair intensity  $\mu_e = 0.0085975507 \text{ 1/min} = 0.515853042 \text{ 1/h}$ .

### Reliability analysis

Based on the testing of time between failure sample, the reliability of an excavator (probability that it will perform its specified function for a given time) can be shown by the exponential distribution forms, i.e. equation (1) can be used:

$$R(t) = e^{-\lambda_e t} = e^{-0.00683118 \cdot t} , \quad (1)$$

where  $\lambda_e [1/h]$  is the failure rate of the excavator.

On the contrary, the probability that the system will fail in a period of given time is framed inside the definition of unreliability and it can be determined by following Equation 2.

$$F(t) = 1 - e^{-\lambda_e t} = 1 - e^{-0.00683118 \cdot t} \quad (2)$$

Figure 3 provides a graphical representation of the change in excavator's reliability and unreliability in a period of one month, approximately 30 days (720 h).

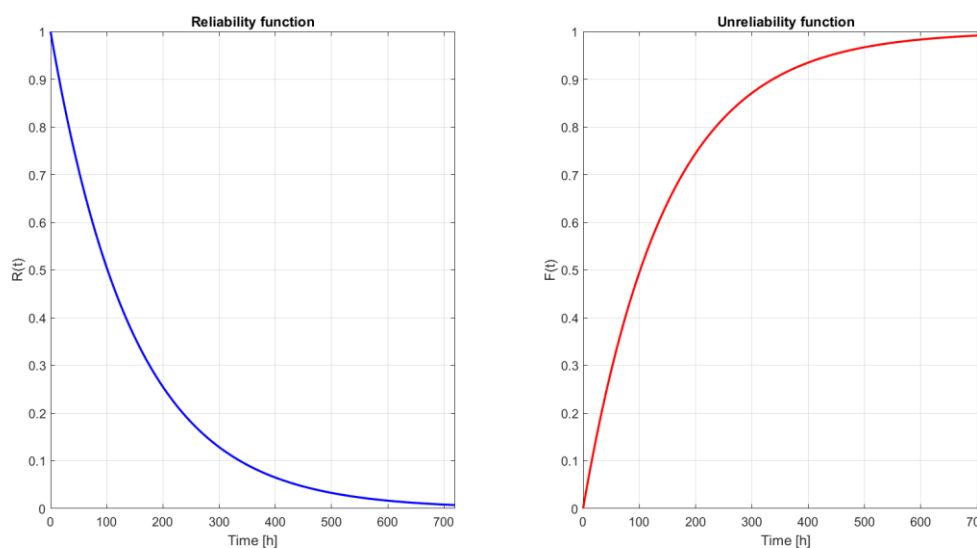
The average operating time between the failures ( $MTBF_e$ ) of excavators is equal to:

$$MTBF = \frac{1}{\lambda_e} = \frac{1}{0.00683118} = 146.39 \text{ h} \quad (3)$$

The average delay time due to the failures ( $MDT_e$ ) of excavators is equal to:

$$MDT = \frac{1}{\mu_e} = \frac{1}{0.515853042} = 1.94 \text{ h} , \quad (4)$$

where  $\mu_e [1/h]$  is the repair rate of the excavator.



**Fig. 3.** System's reliability and unreliability over time



*Risk assessment model*

International standard ISO/IEC 31010 defined and described one of the most common tools for risk assessment and management for complex technical systems, the FMEA method (Failure Modes and Effects Analysis) [11]. According to the method, risk level is evaluated by calculating the risk performance number (RPN). Three partial indicators (each being evaluated from 1 to 5) are integrated into the risk performance, which directly describe risk as a comprehensive concept [12].

Finally, overall RPN for all failures that indicates the level of overall risk in hydraulic excavators is given Equation 8.

$$RPN = S \cdot O \cdot D \quad (5)$$

The first partial indicator is the severity of consequences (S). This indicator aims to quantify the effects of the incident so that the severity of it may be more precisely evaluated. The severity of the failure is measured by total costs (TC) which are generated as a consequence of excavator not working and include repair costs and lost revenue. According to [13], for every hour in which machine doesn't work, the company loses 66.6125 EUR, i.e.  $ATC = 66.6125$  [EUR/wh]. Having that in mind, ranking of event's severity is given in Table 1.

**Table 1.** Severity of consequences evaluation

Criterion	Severity of consequences	Rank
$TC \leq 100$ [EUR]	Very Low	1
$100 < TC \leq 300$ [EUR]	Low	2
$300 < TC \leq 600$ [EUR]	Medium	3
$600 < TC \leq 900$ [EUR]	High	4
$TC > 900$ [EUR]	Very High	5

Overall severity rank is evaluated by calculating average total costs per failure:

$$ATC \cdot MDT = 66.6125 \cdot 1.94 = 129.23 \text{ EUR} \quad (6)$$

Therefore, overall severity of consequences is evaluated as Low ( $S = 2$ ).

Another partial indicator is the probability of occurrence (O). It shows the level of uncertainty, i.e. indicates the probability that an unexpected event - failure will occur. Evaluation process based on system's unreliability is given in Table 2. As this indicator changes through time, in order to illustrate its impact, probability of failure is evaluated in four different scenarios shown in Table 3. After the tenth day operating time, the excavator enters a phase defined by "Very High" probability of occurrence, which means that from that on failure is inevitable.

**Table 2.** Probability of occurrence evaluation

Criterion	Probability of occurrence	Rank
$F(t) \leq 0.2$	Very Low	1
$0.2 < F(t) \leq 0.4$	Low	2
$0.4 < F(t) \leq 0.6$	Medium	3
$0.6 < F(t) \leq 0.8$	High	4
$F(t) > 0.8$	Very High	5

**Table 3.** Four scenarios that illustrate how second risk dimension (O) changes through time

Scenario	Operating time	Probability of failure	Rank
I	1 day = 24 h	$F(24) = 0.1512$	1
II	5 days = 120 h	$F(120) = 0.5595$	3
III	7 days = 168 h	$F(168) = 0.6826$	4
IV	10 days = 240 h	$F(240) = 0.8059$	5

Detection (D) presents the third partial indicator and it indicates the attitude of a failure mode that will be recognized by controls and inspections, i.e. when a failure occurs, how easily can the cause of the problem be detected [14]. Ranking of event's detection rate is done based on failure type and it is given in Table 4.

**Table 4.** Detection indicator evaluation

Criterion	Detection rate	Rank
/	Very High	1
Failure type is mechanical.	High	2
Failure type is technological or due to external influences.	Medium	3
Failure type is due to power/electricity.	Low	4
/	Very Low	5

General detection rate of failures in excavators is estimated based on an expected value of ranks:

$$M(R_D) = \sum_{i=1}^4 p_i \cdot R_{Di} = \frac{110}{165} \cdot 2 + \frac{52}{165} \cdot 3 + \frac{3}{165} \cdot 4 + \frac{1}{165} \cdot 3 = 2.37 \quad (7)$$

Having safety as a priority and respecting the previously defined methodology that requires evaluating every indicator with a whole number, final detection rate will be rounded up to a higher number, i.e.  $D = 3$ .

Following the suggestions defined in a cost-based model for monitoring the lifetime of the earth moving machines [13] and different RPN interpretations [12, 15], overall risk classification along with suggested actions is defined in Table 5.

**Table 5.** RPN interpretation

Criterion	Risk level	Suggested actions
$RPN \leq 25$	Very Low	Regular cost analysis once in a year.
$25 < RPN \leq 50$	Low	Cost analysis once in 6 months.
$50 < RPN \leq 75$	Medium	Cost analysis once in 3 months.
$75 < RPN \leq 100$	High	Cost analysis every month.
$RPN > 100$	Very High	Cost analysis as soon as possible.

The primary factor determining the economic lifetime is whether the costs caused by the machine are lower than the cost of renting one at a market price of 70 EUR/wh [13]. Therefore, if the results of the cost analysis indicate that the machine isn't economically justified anymore, i.e.  $ATC \geq 70$  [EUR/wh], machine replacement is suggested.

Finally, overall risk in excavators, with the worst case scenario when it comes probability of failure, is equal to:

$$RPN = S \cdot O \cdot D = 2 \cdot 5 \cdot 3 = 30 \quad (8)$$

According to Table 5, overall risk can be rated as "Low", which indicates that cost analysis should be done once in 6 months. Graphical representation of highlighted excavator's RPN in a three dimensional risk matrix is shown in Figure 4.

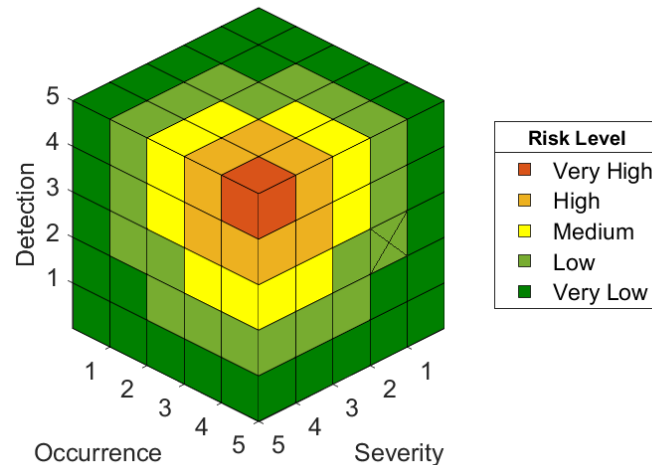


Fig. 4. Excavator's RPN in a 3D Risk Assessment Matrix

## CONCLUSION

Failure risk assessment has been proposed by a number of authors as an essential additional requirement for creating an adequate maintenance strategy. Unexpected machine breakdowns can, along with other consequences, generate economic consequences that are substantial in the company's overall development. The results of the study showed that usage of the monitored excavator is currently economically justifiable, i.e. it generates more revenue than the total costs needed for its functioning, as it fulfills the lowest defined risk class. Higher risk classes inside the framework imply different suggestions in terms of more frequent cost analyses. As the machine climbs the risk latter through years of exploitation, the probability of it becoming loss-making grows. In order to become more attentive in recognising the possibility of replacing old machine with a new one, either via outsourcing or buying a new one, risk approach can be a practical solution. Therefore, the methodology for risk evaluation proposed in this study can be used as a tool in reducing maintenance costs of the company and improving overall efficiency. Besides that, the main limitations of this study are the initial sample size and lack of referent risk scores for other auxiliary machines. Therefore, further research should be focused on expanding the existing sample (or gathering a new, bigger one) and applying the defined methodology to the rest of the mentioned equipment so that its maximum utility can be generated.

## ACKNOWLEDGEMENT

This research was supported by the Science Fund of the Republic of Serbia, #GRANT No. 5151, Support Systems for Smart, Ergonomic and Sustainable Mining Machinery Workplaces – SmartMiner and the Ministry of Science, Technological Development and Innovations contract no. 451-03-47/2023-01/200105 from 03.02.2023.

## REFERENCES

- [1] Ignjatović, D., Jovančić, P., Tanasijević, M. et al.: Optimisation of the organization, resources and costs of auxiliary mechanization in order to increase the degree of utilization of tailings and coal systems at the open-pit mines of electric power industry of Serbia (in Serbian), Study, Faculty of Mining and Geology, Belgrade, 2018.
- [2] Janković, I.: Optimisation of the Life Cycle concept of Auxiliary Machinery at Lignite Open-pit Mines (in Serbian), PhD Thesis, University of Belgrade - Faculty of Mining and Geology, 2020. <https://uvidok.rcub.bg.ac.rs/handle/123456789/3788> (2020, accessed 14 September 2023).

- [3] Bugarić, U., Tanasijević, M., Polovina D., Ignjatović, D., Jovančić, P.: Reliability of rubber conveyor belts as a part of the overburden removal system - case study: tamnava-east field open cast mine. *Tehnički vjesnik*, vol. 21, no. 5, pp. 925–932, 2014.
- [4] Harish Kumar, N.S., Choudhary R.P., Suryanarayana Chivukula, M.: Failure rate and reliability of the KOMATSU hydraulic excavator in surface limestone mine. *AIP Conference Proceedings*, vol. 1943, 020007, 2018.
- [5] Ghomghaleh, A., Khaloukakaie, R., Ataei, M., Barabadi, A., Nouri Qarahasanlou, A., Rahmanil, O., Beiranvand, A.: Prediction of remaining useful life (RUL) of Komatsu excavator under reliability analysis in the Weibull-frailty model. *PLOS ONE*, vol. 15, no. 7, p. e0236128, 2020.
- [6] Harish Kumar, N.S., Manjunath, C., John, R.P., Chand, R.P., Madhusudhana, S., Venkatesha, B.K.: Reliability, availability and maintainability study of 6.5 cubic meters shovel and 60 tone dumper in a surface limestone mine. *Materials Today: Proceedings*, vol. 54, pp. 199–204, 2022.
- [7] Liu, W., Zeng, Q., Wan, L., Liu, J., Dai, H.: Reliability Importance Measures considering Performance and Costs of Mechanical Hydraulic System for Hydraulic Excavators. *Journal of Sensors*, vol. 2022, p. e5748288, 2022.
- [8] Spasojević Brkić, V., Misita, M., Brkić, A., Veljković, Z., Perišić, M., Papić, N., Janev, N.: Risk Management and Excavator Downtime Analysis. *12th International Symposium Engineering Management and Competitiveness 2022 (EMC 2022)*, p. 98, 2022.
- [9] Velikanov, V.S., Dyorina, N.V., Panfilova, O.R., Dyorina, K.S.: Failure risks of mine excavators in ranking control levels. *IOP Conf Ser: Mater Sci Eng*, vol. 709, no. 2, p. 022031, 2020.
- [10] Kumar, P., Kumar, A.: Methods for Risk Management of Mining Excavator through FMEA and FMECA. *The International Journal Of Engineering And Science (IJES)*, no. 5, pp. 57–63, 2016.
- [11] IEC 31010:2019(en,fr), Risk management — Risk assessment techniques / Management du risque — Techniques d'appréciation du risque, <https://www.iso.org/obp/ui/en/#iso:std:iec:31010:ed-2:v1:en,fr> (accessed 24 September 2023).
- [12] Đenadić S. Development of a synthesis risk management model for bucket-wheel excavators (in Serbian), PhD Thesis, University of Belgrade - Faculty of Mining and Geology, 2022. <https://nardus.mppn.gov.rs/handle/123456789/21410> (2022, accessed 24 September 2023).
- [13] Bugarić, U., Tanasijević M., Đenadić, S., Ignjatović, D., Janković I.: Development of the Cost-Based Model for Monitoring the Lifetime of the Earth Moving Machines. *Machines*, vol. 10, no. 11, p. 995, 2022.
- [14] Wang, Y., Cheng, G., Hu, H., Wu, W.: Development of a risk-based maintenance strategy using FMEA for a continuous catalytic reforming plant. *Journal of Loss Prevention in the Process Industries*, vol. 25, no. 6, pp. 958–965, 2012.
- [15] Subriadi, A.P., Najwa, N.F.: The consistency analysis of failure mode and effect analysis (FMEA) in information technology risk assessment, *Heliyon*, vol. 6, no. 1, p. e03161, 2020.



**XIII International Conference Industrial  
Engineering and Environmental  
Protection 2023 (IIZS 2023)  
October 05-06, 2023, Zrenjanin, Serbia**

---

# **Session 4**

# **Oil and Gas Engineering**



## SELECTION OF THE METHOD OF UNDERGROUND EXPLOITATION OF DEPOSITS ON THE BASIS OF THEIR IMPACT ON THE ENVIRONMENT

Dejan Bogdanović<sup>1</sup>

<sup>1</sup>University of Belgrade, Technical Faculty in Bor, Bor, Serbia

e-mail: [dbogdanovic@tfbor.bg.ac.rs](mailto:dbogdanovic@tfbor.bg.ac.rs)

**Abstract:** In mines with underground mining of mineral raw materials, depending on the geometry of the deposits and the mining method used, there is a risk of accidents and a risk to the ecological factors of the environment, especially the soil and surface and groundwater. In past practice, the least attention was paid to the impact on the environment when selecting the appropriate mining method. Mining geology, mining technology, and economic factors dominated the process of selecting the mining method. For this reason, this paper presents the method of selecting mining methods based on their impact on the environment. Four basic groups of mining methods used in our country (Serbia) were considered. The AHP method was used for the ranking, using the four most important criteria for the analysis. From the results, it can be seen that the methods in which the excavation spaces are filled have the least impact on the environment (cut-and-fill methods).

**Key words:** underground mining, environment, method ranking

### INTRODUCTION

Mines with underground extraction of mineral resources can endanger the ecological factors of the environment. This can be the large-scale collapse of mining areas, which leads to subsidence (demolition) of the earth's surface and endangers structural facilities [1], then the infiltration of groundwater into the mine workings, which changes the underground water regime within the mining field [2], and in some cases the infiltration of mine and fire gases, which can locally pollute the ambient air, as well as deforestation and the disintegration of biomes and the effects of land erosion. The probability of an accident in a mine with underground mining, which may be reflected on the surface of the earth, depends on the geometry (shape, type of deposit, depth and size) of the deposit, the mining method used, the geological and hydrogeological characteristics of the cap rock of the deposit, etc.

Up-to-date considerations indicate that the underground mining method selection depends on a three main groups of relevant factors, i.e.:

- mining-geological factors, such as: ground conditions, thickness, general shape, depth below the surface, hangingwall and footwall, ore plunge, grade distribution, quality of resource, etc.
- mining-technical factors, such as: annual productivity, mine recovery, flexibility of methods, applied equipment, machinery and mining rate, and
- economic factors, such as: capital costs, operating costs, mineable ore tons, orebody grades and mineral value.'

The modern approach considers the selection of exploitation method as an MCDM problem with a finite number of alternatives that must be ranked according to certain criteria. The advantage of these methods is that they consider both financial and non-financial criteria. The best known of these methods are Scoring Models, Analytical Hierarchical Process - AHP, Analytical Network Process - ANP, Axiomatic Design - AD, Utility Models, TOPSIS, ELECTRE and PROMETHEE.

As can be seen, the choice of excavation method does not sufficiently consider its impact on the environment. Although there are many studies and analyzes on the impact of underground mines on the environment [3-6], this fact and the results obtained are still not

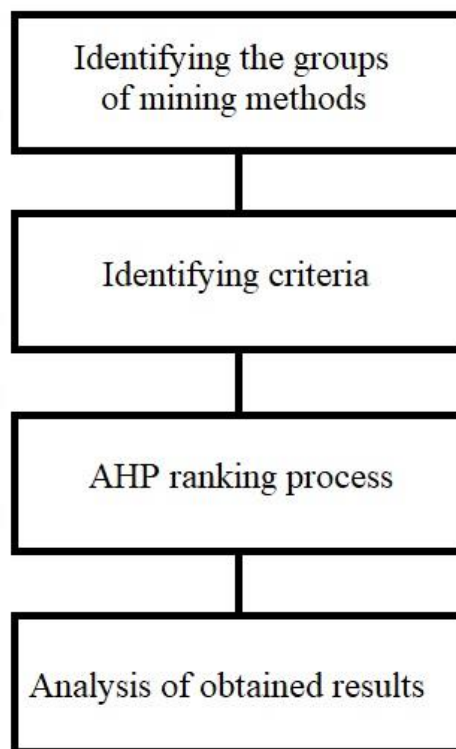
considered as an important group of factors that should have a great influence on the selection process of the mining method. For this reason, in this work, a ranking of the most important groups of mining methods was made from the point of view of their impact on the environment and in accordance with the corresponding most influential criteria.

The aim of the ranking is to identify the groups of methods that have the least negative impact on the environment and to take into account the obtained results when deciding on the choice of mining method in underground mines to a greater (necessary) extent.

The basic limitation of this work is that only one group of factors is considered for the selection of the mining method - the impact on the environment, while the other groups of factors are omitted. In the final decision on the mining method selection, all groups of influencing factors should be taken into account, and it is recommended to include this group – the impact on the environment.

## MATERIAL AND METHODS

The appropriate work methodology is determined to achieve optimal results. The unique working methodology defined by the author is shown in Fig. 1.



*Fig. 1. Schematic presentation of the work methodology*

Fig. 1 shows that the research begins with the process of identifying the groups of mining methods. The methods were identified based on a literature review and on the methods used in mining companies in our country.

In the next phase, the criteria will be established based on a literature review and interview with mining experts and managers in our mines. The final list of groups of mining methods and criteria will be determined after these two phases.

Then, the criteria were first ranked to determine the most influential criteria. The next step involves ranking the groups of mining methods. The AHP method was used for ranking, and the grades were assigned by the group decision method (author with managers and experts from underground mines in our country's mines).

After the ranking was made, the results were analysed with the aim of identifying the best groups of mining methods with the least negative impact on the environment.



## AHP METHOD

AHP is a quantitative method for evaluating alternatives and decomposes a complex decision problem into a multidimensional hierarchical structure consisting of objectives, criteria, and alternatives. Using the AHP method, the influence of the criteria is determined, the alternatives are compared with respect to each criteria, and finally a ranking of the alternatives is established [7].

*Table 1. AHP comparison scale*

<b>Dominance</b>	
<b>Description</b>	<b>Mark</b>
Equal	1
Weak dominance	3
Strong dominance	5
Very strong dominance	7
Absolute dominance	9
2, 4, 6, 8 are intermediate values	

The comparison matrix is the basis for the mutual comparison of the criteria and the comparison of the alternatives with respect to each criteria. The purpose of the comparison is to determine the magnitude of the influence of the criteria on the ranking result and the "strength" of each alternative. These quantities are called weighting coefficients. They are determined using appropriate scores that evaluate the criteria and alternatives. The degree of consistency is also calculated, the value of which must be less than 10% (0.1) for the ranking result to be accepted. The comparison of criteria and alternatives is done using a scale with scores from 1 to 9 – Tab. 1.

The final ranking of the alternatives is determined by the synthesis of the results obtained at all levels.

## RESULTS AND DISCUSSION

### Identification of the groups of mining methods

As mentioned above, the groups of underground mining methods were identified based on a literature review and mining practises in our country.

Underground mining of mineral deposits can be done by the following groups of methods:

- Open stoping with collapse of the rock above the deposit (depending on the size of the cavities, their depth and the nature of the overburden, collapse of the overburden, damage to the soil and buildings above the deposit, and underground and surface water may occur) – Alternative A1.
- Shrinkage stoping with cutting of blocks and natural or forced demolition and mining of ores (these are the same methods used in demolition of roofs, which can cause an accident on the earth's surface) – Alternative A2.
- Room-and-pillar methods, in which open spaces are left with protective pillars to prevent collapse of surrounding rock masses (these methods may result in roof collapse depending on the strength of the rock and depth of excavation) – Alternative A3.
- Cut-and-fill methods, in which the excavated voids are filled by backfill of sufficient strength and compressibility. After excavation, the open spaces are filled in order to avoid deformation of the roofs and endangering the ecological factors of the environment – Alternative A4.

### Identification of the criteria

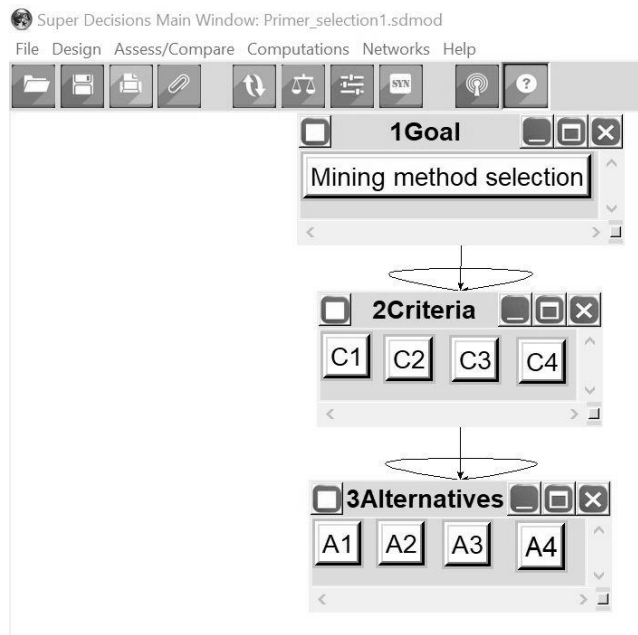
Identification of the criteria is done based on a literature review and interview with mining experts and managers in our mines. Four most important criteria were identified, namely:

- Safety (parameter on the basis of which the safe excavation depth is determined in relation to the protected object. Its value depends on the depth (thickness) of the roof of the deposit and the apparent height (thickness) of the deposit, i.e. on the cavity resulting after the excavation of the deposit) – Criteria C1.
- Hazard category (indicates the degree of danger to the environment. There are four hazard categories - I (low), II (medium), III (high) and IV (very high) – Criteria C2.
- Risk probability (a parameter that defines the probability of an accident in mining. The probability value ranges from 0 to 1, i.e. from 0% to 100%) – Criteria C3.
- Mine location (proximity to buildings, type of vegetation, soil types, watercourses, groundwater, other infrastructure) – Criteria C4.

### AHP ranking process

After all alternatives and criteria have been identified, the AHP method is applied. The Super Decision software was used for ranking. As mentioned earlier, the objective of the ranking is to identify the best groups of mining methods with the least negative impact on the environment.

The ranking of the measures was performed by managers and mining experts, as mentioned above. First, a multidimensional hierarchical structure of goals, criteria, and alternatives was established – Fig. 2. In Tab. 2. a comparison matrix for the criteria is given in order to define their influence on the final ranking of alternatives – groups of mining methods.



**Fig. 2.** Multidimensional hierarchical structures of goals, criteria and alternatives

**Table 2.** Comparison marks of criteria

	<b>C1</b>	<b>C2</b>	<b>C3</b>	<b>C4</b>
<b>C1</b>	1	3	3	2
<b>C2</b>		1	1	1/2
<b>C3</b>			1	1/3
<b>C4</b>				1

After the calculation, the weighting coefficients of the criteria were calculated using the scores in Tab. 2. (the results are shown in Fig. 3). The degree of inconsistency is 0.01716, which is less than 0.1, so the results are consistent.

In the next step, the groups of mining methods (alternatives) are compared with respect to all four defined criteria – Tab. 3-6.

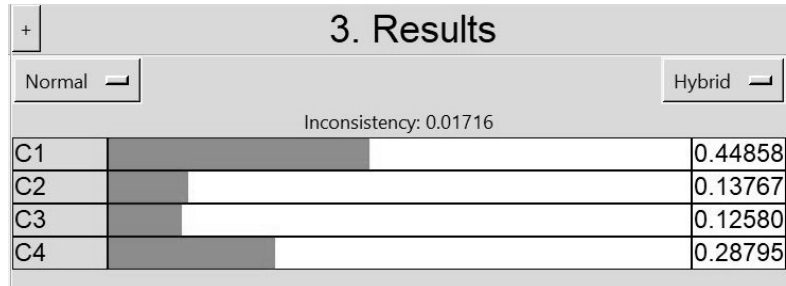


Fig. 3. The obtained weighting coefficients of the criteria

Table 3. Comparison of the alternatives with respect to criteria C1

	A1	A2	A3	A4
A1	1	1/3	1/5	1/7
A2		1	1/4	1/6
A3			1	1/3
A4				1

Table 4. Comparison of the alternatives with respect to criteria C2

	A1	A2	A3	A4
A1	1	1/4	1/6	1/8
A2		1	1/3	1/7
A3			1	1/3
A4				1

Table 5. Comparison of the alternatives with respect to criteria C3

	A1	A2	A3	A4
A1	1	1/2	1/4	1/5
A2		1	1/2	1/3
A3			1	1/2
A4				1

Table 6. Comparison of the alternatives with respect to criteria C4

	A1	A2	A3	A4
A1	1	1	1/2	1/3
A2		1	1	1/2
A3			1	1
A4				1

Finally, the results of the ranking of the alternatives were determined, which are shown in Fig. 4.



**Fig. 4.** The obtained final rank of the alternatives

### **Analysis of obtained results**

The analysis includes the criteria and their impact on the ranking result, as well as the alternatives (groups of excavation methods).

The analysis of the criteria focuses on the value of their weighting coefficients. Namely, the weighting coefficients of the criteria represent their degree of influence on the ranking result of the alternatives.

From Fig. 3, it can be seen that criteria C1 (safety) has the greatest influence on the ranking result, as its weighting coefficient is 0.44858. This shows that safety comes first in the ranking of mining methods and that these methods pose the least possible risk to the environment, including people and their property.

Criteria C4 (mine location) comes second. The location of the mine is very important because it determines the degree of impact of the mining method on the environment. It is desirable that mines be located farther away from populated areas, large watercourses, etc. In our country the situation is "mixed", i.e. a number of mines are located near or even in the settlements themselves, while the rest are further away from the settlements.

Criteria C2 (hazard category) is in third place. The categorization of excavation methods allows a more accurate assessment of their impact on the environment. Each group of methods was classified into a specific group and on this basis the evaluation was carried out using the AHP method.

Criteria C3 (risk probability) is in the last. Although it is in the last place, its influence on the final result of the ranking is significant. Risk is associated with each mine and depends largely on the mining method used.

Regarding the alternatives (group of excavation methods) in Fig. 4, it can be seen that it is best to use cut-and-fill methods (alternative A4). These methods cause minimal damage to the overlying ground surface by filling the excavated spaces, and the backfill can largely replace the excavated ore. For all these reasons, this group of methods has the least impact on the environment.

In second place is the room-and-pillar methods (alternative A3). The protective pillars left behind by these methods also prevent soil erosion and subsidence of the ground surface, which reduces their negative impact on the environment. Unlike the previous alternative, here there are large empty spaces under the ground, which may sooner or later collapse and lead to greater danger to the environment.

In third place is the shrinkage stopping methods (alternative A2). These methods lead to the collapse of the roof layers of the rock and the appearance of cracks and depressions on the surface of the terrain. For this reason, these methods endanger the environment to a greater extent.

In last place are open stopping methods. These methods are the most dangerous for the environment. They also lead to the collapse of the overburden layers, but to a greater extent, to a significant change in the underground water balance and other negative consequences.

### **CONCLUSION**

In this work, the AHP method was used to rank the groups of mining methods with the goal of determining which method has the least impact on the environment. Four groups of mining methods were considered – open stoping (alternative A1), shrinkage stoping (alternative A2), room-and-pillar methods (alternative A3), and cut-and-fill method (alternative A4).

Four ranking criteria were also considered: - safety (criteria C1), hazard category (criteria C2), risk probability (criteria C3), and mine location (criteria C4).

The ranking of the groups of excavation methods was done using the AHP method for multicriteria decision making. This method was first used to determine the weighting

coefficients of the ranking criteria and then to evaluate the groups of mining methods and determine their complete ranking.

Based on the results obtained by the AHP method, the most favorable group of methods with the least negative environmental impact was determined, which was alternative A4 (cut-and-fill method). The most influential criteria for the complete ranking of the groups of mining methods is criteria C1 (safety).

At this point, it should be noted that the final selection of mining method depends on other factors that are not considered here, such as mining-geological, mining-technical, and economic factors. It is recommended that in the future, when selecting the mining method in underground mines, this group of factors – the impact on the environment – should also be taken into account.

## ACKNOWLEDGEMENTS

The research presented in this paper was carried out with the financial support of the Ministry of Education, Science and Technological Development of the Republic of Serbia, as part of the funding of scientific research work at the University of Belgrade, Technical Faculty in Bor, according to the contract with registration number 451-03-47/2023-01/200131.

## REFERENCES

- [1] Betournay, M. C. *Underground Mining and Its Surface Effects*. 2011. Available at <http://www.fhwa.dot.gov/engineering/geotech/hazards/mine/workshops/iawkshp/betourna2.cfm>
- [2] Miranda, M., Blanco-Urbe Q., A., Hernández, L., Ochoa G., J., Yerena, E.: *All That Glitters Is Not Gold: Balancing Conservation and Development in Venezuela's Frontier Forests*. World Resource Institute, USA, 1998.
- [3] Altun, O. A., Yilmaz, I., Yildirim, M., *A Short Review on the Surficial Impacts of Underground Mining*, Scientific Research and Essays, Vol. 5(21), pp. 3206-3212, 2010.
- [4] Naveen Saviour, M., *Environmental Impacts of Soil and Mining: A Review*, International Journal of Science, Environment and Technology, Vol. 1, No. 3, pp. 125-134, 2012.
- [5] Ratan, R. T.: *Surface and Underground Excavations – Methods, Techniques and Equipment*, A.A. Balkema Publishers, Taylor & Francis Group, New York, 2005.
- [6] Sahu, H. B., Prakash, N., Jayanthu, S., *Underground Mining for Meeting Environmental Concerns – A Strategic Approach for Sustainable Mining in Future*, Procedia Earth and Planetary Science Vol. 11., pp. 232 – 241, 2015.
- [7] Saaty, T.L.: *The Analytical Hierarchy Process*, McGraw-Hill, New York, 1980.



## BASIC ELEMENTS OF DESIGNING AND CONSTRUCTION OF GAS MEASUREMENT AND REGULATION STATIONS

Jasna Tolmač<sup>1</sup>, Saša Jovanović<sup>1</sup>, Slavica Prvulović<sup>1</sup>, Milan Marković<sup>1</sup>

<sup>1</sup>University of Novi Sad, Technical Faculty "Mihajlo Pupin", Zrenjanin, Serbia  
e-mail: jasna.tolmac@tfzr.rs

**Abstract:** Designing and building gas measurement and regulation stations (GMRS) implies knowledge of technical conditions. Technical conditions refer to a specific GMRS project. They prescribe the characteristics of the equipment to be installed, the installation conditions, the method of testing the installations, etc. According to [1 - 10], the technical requirements for designing and building a system of process and gas technology for a certain type of installations that are usually encountered in practice are listed. In this paper, the technical conditions for the construction of the main gas measuring and regulating station (GMRS) are given, as well as a short technical description. GMRS, implemented in practice, are also shown. The data provided can be useful to engineers, designers, contractors and students.

**Key words:** designing, construction, measurement, regulation, gas

### INTRODUCTION

The main measurement and regulation stations are facilities that connect the main gas pipeline with the gas pipeline of the city network, where filtering, reheating, pressure reduction and natural gas flow measurement are carried out, [1, 2].

Fittings and equipment gas measurement and regulation stations (GMRS) and boiler rooms are located in the building. The floor of the room where the GMRS armature is placed is made of non-combustible material, and the roof is made of light material. The door opens into the field (dimensions 2.05 x 1.50 m). The room is ventilated naturally by means of ventilation openings placed near the floor and at the highest points of the building. The height of the building is 3.5 m, and the outer walls have no window openings, Figure 1.

The GMRS fittings are located in the facility in a room separated from the boiler room by an impermeable, fireproof wall. All pipes and fittings, from the inlet to the outlet of the gas pressure regulator, are according to ANSI 300. Behind the pressure regulator, all fittings and connecting elements are PN16, [2, 3].

The regulatory group consists of a filter, a reheater, a blocking valve, a pressure regulator, a safety relief valve, a non-return valve, permeable valves (taps), manometers and thermometers. The appearance of the GMRS armature is given in Figure 2.

The regulatory group consists of two lines, one working and one reserve. The lines are dimensioned for 100% of the maximum capacity, for a minimum inlet pressure of 12 bar and an outlet pressure of 4 bar. The detail of the installation of the regulating valve is given in Figure 3. The measuring group consists of one working line and a bypass line. The measuring line is dimensioned for 100% of the maximum capacity and an output pressure of 4 bar, as well as an output group with an electric valve (flow limiter). Connections for telemetry are placed at the inlet and outlet of the gas pipeline, [4].

Due to solid and liquid impurities that contain gas, in order to prevent damage and improper operation of the regulation and measuring fittings, a gas filter is installed at the entrance of the regulation line. In Figure 4, a detail of the filter replacement is given [5].

The fine filter is equipped with a condensate collector and a differential pressure gauge, which is used to control the dirtiness of the filter cartridge. When replacing the filter cartridge, gas is passed through the reserve line.

Condensate discharge is carried out through de-sludge valves and pipes outside the GMRS facility.

When the gas pressure is reduced, the gas expands, resulting in a drop in temperature (Joule-Thomson effect). With large gas pressure reductions, this effect can lead to the appearance of ice in the installation, which is particularly dangerous in regulation and safety devices, Figure 5. That is why it is necessary to reheat the gas before the reduction (in front of the pressure regulator), especially with GMRS, [3], [6]. In this regard, an example of the choice of a gas reheater is given, [3]. Figure 6 shows the appearance of gas reheaters, manufactured by GasTeh - Indjija, which are produced as standard with an installed thermal power of 8 - 1320 kW.

Selection of gas reheater: The required amount of heat for gas heating is determined by the following parameters:

$Q_g = 17500 \text{ m}^3/\text{h}$	- maximum gas flow
$c_p = 1,95 \text{ kJ/m}^3\text{K}$	- specific heat capacity under given conditions
$P_1 = 50 \text{ bar}$	- maximum possible inlet pressure
$P_2 = 4 \text{ bar}$	- output pressure
$t_1 = 5 \text{ }^\circ\text{C}$	- gas temperature at the entrance to the station
$t_2 = 15,5 \text{ }^\circ\text{C}$	- gas temperature at the outlet of the station
$0,4 \text{ }^\circ\text{C/bar}$	- average drop in gas temperature due to pressure reduction

$$Q_w = \frac{Q_g \cdot c_p}{3600} \cdot ((P_1 - P_2) \cdot 0,4 + (t_2 - t_1))$$

$$Q_w = 274 \text{ kW}$$

This calculation corresponds to the hot water gas reheater 90/70 °C, DN200 ANSI300, type 1040 "Energosystem".

Gas reheating is done indirectly, through hot water, in gas reheaters. The reheaters are supplied with a safety valve and a de-sludge valve, [3], [7].

## MATERIAL AND METHODS

1. Before starting the assembly work on the installation, it is necessary to determine the exact location of the station and prepare the space for contractor operations. Unless otherwise required, the following minimum distances of the station from other objects should be observed:

- 10m from buildings
- 10m from the railway and tram lines
- 5 m from main and regional roads
- 5m from overhead power lines

2. When performing assembly work, it is recommended that the contractor perform the fabrication and test assembly of the subassemblies in his workshop, so that he only assembles the subassemblies on the spot. All installed equipment must have appropriate certificates and must comply with the requirements of the gas distributor.

3. The most important operation during assembly is the butt welding of pipes, flanges, arches and shaped pieces, so special attention should be paid to this, both during the preparation and professional qualification of the welder, as well as during the organization and performance of the works.

4. This operation is preceded by the cleaning of internal pipes and other mentioned elements from all impurities and foreign objects. Cleaning is carried out with wire brushes designed for this type of work. When cleaning the pipe, the use of rough tools (cutter, file, etc.) is not allowed.



The open ends of the pipelines must be closed every day after the end of the work, with so-called night caps and must not be opened until the work continues.

5. After this, the pipe ends, flanges, arcs and shaped pieces are checked using the appropriate tool. If the ends are damaged, the necessary repairs should be made. If these ends cannot be repaired, they should be cut off and the edges re-beveled, or replaced with correct flanges, elbows or fittings.

6. When the ends to be welded are brought to the correct condition, centering is performed with another pipe or the corresponding element to be welded. By centering, the proper distance between two pipes or between the pipe and the corresponding element to be welded is achieved.

7. Welding is done in two layers: root weld and filler. The quality control of the performance of each layer must be carried out constantly, and all the necessary data for correcting a possibly poorly performed welded joint should be entered in the welding book.

8. Welding can be done if the ambient temperature is above 0°C, and if there is no wind or rain. The material should be preheated up to a temperature of -5°C, and welding should be stopped at lower temperatures.

9. It is recommended that welding be performed with special deep and uniformly penetrating electrodes that have a very penetrating and easily controlled arc.

10. In addition to this, control radiographic imaging of welds should be performed. This recording should be done with  $\gamma$  and x rays, according to the method and specification that the contractor should submit in advance for the approval of the investor, and it is recommended according to API standard 1104, the latest edition. It is necessary to examine all welds (100%).

11. All established defective welds should be repaired or cut out of the gas pipeline, then welded again and recorded. This error correction is performed as specified in ANSI B.31.8.

12. When welding flanges, take care that all those that are welded on pipes must be at right angles to the axis of the pipe. The deviation of the parallelism of the flange surfaces to be joined can be  $\pm 0.5^\circ$ .

13. The tolerance of the gap between the flanges must be  $\pm 0.1$  mm in relation to the thickness of the sealant. Bolts should be tightened in a crosswise, and never in order. In doing so, take care not to skip the tightening force, so it is recommended to work with a tool that has a device for measuring the tightening force.

14. The distance between the flanges must correspond exactly to the length of the pipe element. The distance tolerance must be within  $\pm 0.1$  mm. Any larger deviation can lead to an accident. The sealing material must be of good quality and of equal thickness everywhere. Unequal thickness causes non-parallelism of the sealing surfaces, and thus the appearance of additional stress. The bolts must be cross-tightened with the greatest attention. Here it is recommended to use a tool that has a device for measuring the tension force.

15. After the installation of the station has been completed, a strength and tightness test should be performed. Before the test, the installation must be thoroughly cleaned by blowing with air. For pressures up to 3 bar, testing is done with air, and for higher pressures with water.

16. During the strength test, the test pressure is maintained for at least 4 hours, after which the pressure is lowered to the value determined for the impermeability test. From the test, it is necessary to exclude sensitive equipment that may be damaged by the test, which was

previously tested at the factory (e.g. gauges, regulators, etc.), and in their place, put pipe inserts or protect them with shutters. If the test is performed with air, all joints are coated with a foaming agent and a constant visual control is performed to see if there is a leak.

17. Deficiencies established by this test are removed only after the pressure in the pipeline is reduced to atmospheric. After eliminating all identified defects, the test must be repeated. If no permanent deformations occurred during the strength test, and no leaks occurred at the joints, the installation is considered satisfactory.

18. The tightness test lasts at least 24 hours, during which there must be no pressure drop. The test begins when the temperature of the test medium has stabilized. During the test, the gas pipeline and fittings are inspected. If the inspection is carried out by air, the permeability of welded and flanged joints is checked with a solution of soap in water.

19. The discharge pressure for strength testing is 50% higher than the maximum working pressure, but at least 2 *bar* higher than the maximum working pressure. Pressures are calculated separately for the inlet part of the station (including the pressure regulator) and the outlet part of the station (behind the regulator). All pressure values are manometric, i.e. it is overpressure. Items (1-19) are cited from the literature [2], [4], [6], [8].

### **LETTING GAS INTO THE INSTALLATION**

After the test, if all conditions are fulfilled, the installation can be put into operation. When putting the installation into operation, the introduction of gas should be carried out in such a way as to prevent the creation of an explosive gas-air mixture. This can be achieved either by injecting inert gas at the entrance to the GMRS, which will serve as a gas and air separator, or by letting the gas into the installation at the lowest possible speed (slightly opening the valve) to reduce as much as possible the possibility of creating an explosive mixture in the contact zone gas and air, [9].

Gas is released from the installation on the outlet collector and exhaust valves. During discharge, the gas content in the outgoing air is controlled using a gas-air mixture analyzer (gas detector). When the detector determines that the air content in the outgoing mixture is minimal, the exhaust valves are closed. In this way, the installation is filled with gas, [10].



**Fig. 1.** Installation GMRS



**Fig 2.** Measuring and regulating station (MRS), with two lines for pressure reduction and a line for measuring gas quantities



**Fig 3.** Detail of the installation of the control valve



**Fig 4.** Filter replacement detail





**Fig 5.** Freezing of gas installation



**Fig 6.** Gas heater, GasTeh – Indjija

## CONCLUSION

In this paper, the technical conditions for the construction and design of the main gas measuring and regulating station (GMRS) are given, as well as a brief technical description. The key elements of GMRS, implemented in practice, are also presented. The data provided can be useful to engineers, designers, contractors and students.

## REFERENCES

- [1] Tolmac, D., Design of technological systems, Technical Faculty "Mihajlo Pupin", Zrenjanin, 2008.
- [2] Tolmac, D., Design elements of the main measuring and regulation stations for natural gas, "SM Engineering", Zrenjanin, 2005.
- [3] Prvulovic, S., Tolmac, D., Tolmac, J., Process systems and plants, Technical Faculty "Mihajlo Pupin", Zrenjanin, 2014.
- [4] Bogner, M., Design of thermotechnical and process systems, SMEITS, Belgrade, 2007.
- [5] Isailovic, M., Bogner, M., Regulations of planning and construction, Eta, Belgrade, 2006.
- [6] Bogner, M., Propane and Butane, Eta, Belgrade, 2008.
- [7] Bogner, M., Petrovic, A., Constructions and calculations of process apparatus, Faculty of Mechanical Engineering, Belgrade, 1991.
- [8] Tolmac, D., Machines and Apparatus, Technical Faculty "Mihajlo Pupin", Zrenjanin, 2009.

- [9] Sasic, M., Transport of fluids and solid materials by pipelines, Science book, Belgrade, 1990.
- [10] Bogner, M., Compressor Plants, Eta, Belgrade, 2008.



**XIII International Conference Industrial  
Engineering and Environmental  
Protection 2023 (IIZS 2023)  
October 05-06, 2023, Zrenjanin, Serbia**

---

# **Session 5**

# **Engineering Management**



## THE APPLICATION OF NEURAL NETWORKS IN FINANCIAL RISK MANAGEMENT

Duško Petrović<sup>1</sup>, Ivana Jošanov-Vrgović<sup>1</sup>

<sup>1</sup>Collage of Organizational Studies EDUKA Beograd, Serbia

e-mail: [dusko.petrovic@vos.edu.rs](mailto:dusko.petrovic@vos.edu.rs)

e-mail: [ivana.josanov.vrgovic@vos.edu.rs](mailto:ivana.josanov.vrgovic@vos.edu.rs)

**Abstract:** The paper examines the possibility of applying a neural network for estimating VaR, as a measure of market risk faced by bank portfolios. The model is based on the standard multilayer perceptron model. The results of the model's validity testing demonstrate that it can be effectively used for managing market risks in banks. The research was conducted using the example of the Belgrade Stock Exchange market index, Belex15. Unconditional and conditional coverage tests, as well as the Dufour Monte Carlo test, were used to test the model's validity.

**Key words:** Value at Risk, market risk, Basel standards, artificial neural networks, multilayer perceptron

### INTRODUCTION

In 1996, the Basel Committee on Banking Supervision adopted an amendment to the Basel I standard, granting banks the opportunity to develop their own models for assessing the market risk faced by their portfolios. Since then, banks have been continuously working on the development of models for market risk estimation. Specifically, banks are focused on creating models that are effective in estimating Value at Risk (VaR) as a measure of market risk for their portfolios. The goal is to develop a VaR model that meets the standards of providence control set by the Basel Committee.

Currently, there are two main directions in the development of VaR models. The first direction involves the development of VaR models based on traditional techniques, such as time series modeling and stochastic processes. The second direction explores the potential of applying artificial intelligence, data mining, and machine learning. The development of VaR models that incorporate advancements in information and communication technology (ICT) is particularly supported by the understanding that the return patterns of banks do not follow simple stochastic processes, such as a random walk model, nor linear models like ARMA or ARIMA models, [1].

The application of neural networks in the development of VaR models represents one of the possibilities of leveraging ICT solutions in modeling the return patterns of bank portfolios and predicting their future movements. Numerous authors such as Atsalakis&Valavanis (2009), Thomaidis& Dounias (2012), Aguilar-Rivera et al. (2015), Cavalcante et al. (2016), Chong et al. (2017), Xing et al. (2018), Hiransha et al. (2018), Fischer & Krauss (2018), Rundo et al. (2019), Nti et al. (2019), Shah et al. (2019), Sezer et al. (2020), highlight that neural networks can be more effectively applied in modeling stochastic processes compared to traditional techniques. Hence, the idea that neural networks can be used for developing VaR models to estimate market risk faced by banks. Recent studies ([20], [21],[22],[23],[24]) have indicated

possibility of successful application of neural networks in risk assessment. However, all of them are based on a large amount of data related to the use of big data. On the one hand,

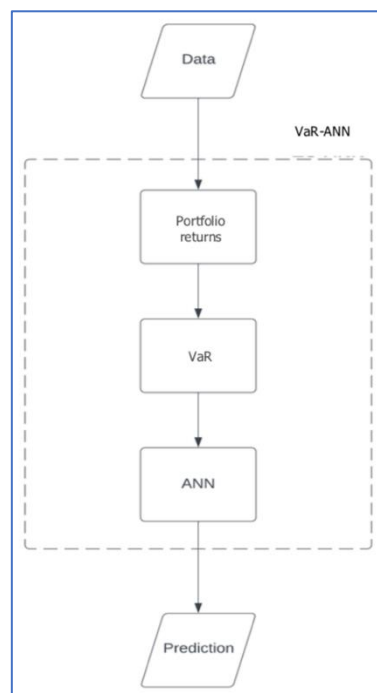


this requires large resources, while on the other hand, the use of large amounts of data on historical returns means that a long historical period is taken care of. However, no one wants to base their risk assessments on historical data that does not reflect current market conditions.

The aim of this study is to address the question of whether it is possible to generate valid VaR estimates that satisfy the providence control conditions defined by the Basel Committee on Banking Supervision through the application of neural networks. The idea is to capitalize on the advantages of the standard multilayer perceptron (MLP) model it possesses: 1) its ability to capture nonlinear dependencies among risk factors of bank portfolios, and 2) its capability to approximate a large number of continuous functions, enabling the incorporation of the behavior of multiple risk factors and their impact on the riskiness of bank portfolios. This allows for reliable risk assessments, even in situations where portfolios are exposed to a large number of external factors.

### THE THEORETICAL BACKGROUND OF THE VAR MODEL BASED ON NEURAL NETWORK

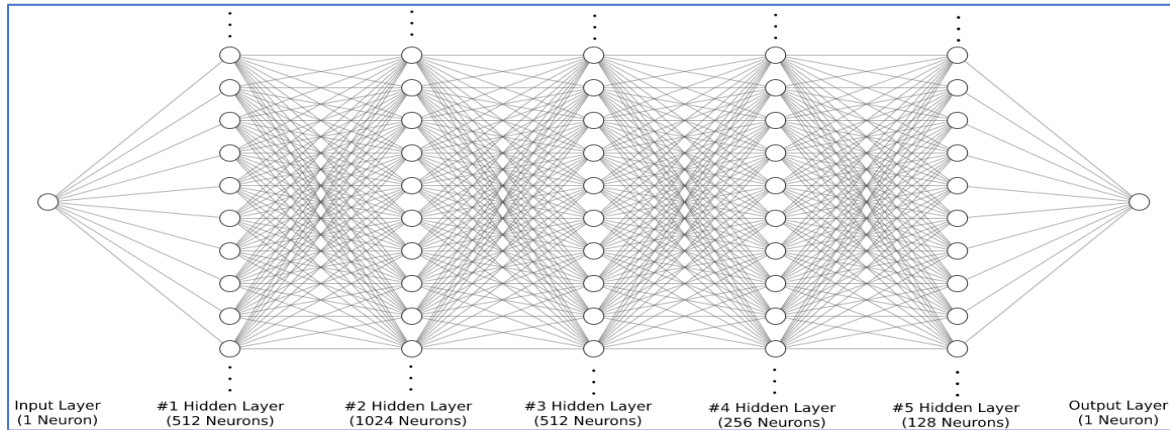
As previously emphasized, the objective of this study is to examine the applicability of a standard multilayer perceptron (MLP) model for VaR estimation, as a measure of market risk faced by bank portfolios. The idea is to leverage the advantages of the standard MLP model. Figure 1 illustrates the structure of the entire model, while Figure 2 presents the architecture of the ANN model specifically. For the purpose of this study, the model is referred to as the VaR-ANN model.



**Fig 1.** VaR-ANN Model architecture

Note: ANN part represents Feedforward Artificial Neural Network with Back-propagation algorithm.

**Source:** Authors' calculations



**Fig 2.** Artificial Neural Network (ANN) architecture  
 Source: Authors' calculations

The ANN model includes an input layer with one neuron, five hidden layers with varying numbers of neurons, and an output layer with one neuron. The specific number of neurons per layer and the activation functions utilized are presented in Table 1.

**Table 1.** ANN Layers information

	#1 Hidden Layer	#2 Hidden Layer	#3 Hidden Layer	#4 Hidden Layer	#5 Hidden Layer	Output Layer
<b>Number of Neurons</b>	512	1024	512	256	128	1
<b>Activation Function</b>	ReLu (Rectified Linear Unit)	ReLu (Rectified Linear Unit)	ReLu (Rectified Linear Unit)	ReLu (Rectified Linear Unit)	ReLu (Rectified Linear Unit)	Linear

Source: Authors' calculations

To development of network utilized daily returns of the Belex15 market index from the Belgrade Stock Exchange. Data was collected from May 5, 2020, to May 5, 2023. Approximately 70% of the data was used for network testing, while the remaining 30% was allocated for prediction testing. Table 2 provides details about the Neural Network Hyperparameters employed in the analysis.

**Table 2 – Information about Neural Network Hyperparameters**

<b>Learning Algorithm</b>	Back-propagation
<b>Optimizer</b>	Adam
<b>Learning Rate</b>	0.01
<b>Loss</b>	Mean Squared Error (MSE)
<b>Epochs</b>	1000

Source: Authors' calculations

The mathematical expression that represents the loss function utilized during network training and testing is as follows:

$$MSE = \frac{1}{N} \sum_{i=1}^N (y_i - \hat{y}_i)^2 \quad (1)$$

Where are:

- $MSE$  - Mean Squared Error
- $y_i$  - actual stock indexes return
- $\hat{y}_i$  - predicted value of VaR
- $N$  - number of data

The MSE (Mean Squared Error) values for testing and training are 0.00035 and 0.00039, respectively, which indicate satisfactory performance.

### VALIDATION TESTING OF THE MODEL IN THE CONTEXT OF BASEL STANDARD PROVIDENCE CONTROL

This section presents the results of the validation testing conducted on the developed model. According to the Basel Committee's regulations, banks are required to perform daily VaR assessments at a 99% confidence level based on a series of historical portfolio return data. For the purposes of this study, VaR estimates were made for the period from May 5, 2022, to May 5, 2023.

According to the rules of the providence control, the VaR model is deemed valid, and banks are allowed to use it if, over a span of 250 days, the actual portfolio loss does not exceed three times the VaR estimate. However, since this criterion is considered too simplistic, in practice, unconditional and conditional coverage tests are employed to demonstrate the validity of the VaR model. These tests can be mathematically expressed as follows:

$$LR_{uc} = 2 \ln \left[ (1-p)^{T-T_1} p^{T_1} \right] + 2 \ln \left[ (1-T_1/T)^{T-T_1} (T_1/T)^{T_1} \right] \quad (2)$$

$$LR_{cc} = LR_{uc} + LR_{ind} \quad (3)$$

$$LR_{ind} = -2 \ln \left[ (1-\pi)^{T_{00}+T_{11}} \pi^{T_{01}+T_{10}} \right] + 2 \ln \left[ (1-\pi_{01})^{T_{00}} \pi_{01}^{T_{01}} (1-\pi_{11})^{T_{10}} \pi_{11}^{T_{11}} \right] \quad (4)$$

where  $LR_{uc}$  is likelihood ratio for unconditional coverage test,  $LR_{cc}$  is likelihood ratio for conditional coverage test,  $LR_{ind}$  is likelihood ratio for independent test;  $(p)$  is the tail probability (or the VaR coverage rate);  $T$  is total number of VaR estimation,  $T_1$  is number of VaR breaks. The number of days when after a no VaR break day occurred a no VaR break day ( $T_{00}$ ), i.e. when after a no VaR break day occurred a VaR break day ( $T_{01}$ ), i.e. when after a VaR break day occurred a no VaR break day ( $T_{10}$ ), when after a VaR break day occurred a VaR break day ( $T_{11}$ ),  $\pi$  is probability that after a hit or an VaR break, an VaR break or a hit will occur.

The results of the validation test, as well as the number of exceedances, are presented in Table 3. From the table, it can be observed that the model generated a VaR estimate that was lower than the actual loss only once [9]. Additionally, it is evident that the model passed both model validation tests.

**Table 3. Backtesting results**

Stock index	BELEXI5
No. of 99% VaR breaks	1
Percent of breaks 99% VaR breaks	0.004
$LR_{uc}$ test	0,03
p-value	0,85
$LR_{cc}$ test	1,20

p-value	0,55
MCS <sub>cc</sub>	0.81

Note: Total number of VaR estimation is 250. Dufour Monte Carlo test was conducted on 10.000 simulation

Source: Authors' calculations

However, due to the limited power of both tests when applied on a restricted dataset, it is necessary to verify their results. For this reason, the Dufour Monte Carlo test proposed by Ziggel et al. (2013)[19]. was employed in the study to validate the findings.

$$MCS_{cc} = a.f(MCS_{uc}) + (1 - a)g(MCS_{iid}), 0 \leq a \leq 1 \quad (5)$$

The function  $f(MCS_{uc})$  is obtained by applying the following expression:

$$f(MCS_{uc}) = \left| \frac{\left( \varepsilon + \sum_{t=1}^N I_t \right) / N - p}{p} \right| \quad (6)$$

that is, the function  $g(MCS_{iid})$  is obtained by applying the following expression:

$$g(MCS_{iid}) = \frac{MCS_{iid} - \hat{r}}{\hat{r}} I\{MCS_{iid} \geq \hat{r}\} \quad (7)$$

To obtain a one-sided test, this expression is multiplied by  $I\left\{ \sum_{t=1}^N I_t / N \geq p \right\}$ , where

$N$  represents the total number of data points, and  $I$  denotes the indicator function, which can be mathematically expressed as:

$$I_{\alpha,t+1} = \begin{cases} 1 & \text{if } r_{t+1} > VaR_{t+1} \\ 0 & \text{if } r_{t+1} \leq VaR_{t+1} \end{cases}$$

As can be seen from Table 3, the model has successfully passed the Dufour Monte Carlo test. The results indicate that the model can be reliably applied in the context of Basel standards for managing financial risks in banking.

## CONCLUSION

The increasing significance of ICT in societal development has also found its application in the banking sector. Namely, the realization that traditional models for financial risk management are not sufficiently efficient in capturing the stochastic movements of bank portfolio values has prompted banks to seek solutions through the application of ICT advancements. One such possibility is the use of neural networks for VaR estimation.

Such a possibility has been explored in this study as well. The aim of this research was to develop a VaR model using the standard multilayer perceptron model, which would be capable of accurately estimating the market risk faced by banks. The research results demonstrate that the model can be successfully applied for this purpose. VaR estimates were made in accordance with the Basel Committee standards. Furthermore, the validation testing of the model was conducted in line with the regulations of the Basel Committee and the customary practices in the banking industry.

## REFERENCES:

- [1] Doncic, S., Pantic, N., Lakicevic, M., Radivojevic, N. Expected shortfall model based on a neural network. *Journal of Risk Model Validation*, Vol. 16, No. 2, 2022.
- [2] Aguilar-Rivera, R., Valenzuela-Rendon, M., Rodriguez-Ortiz, J. Genetic algorithms and Darwinian approaches in financial applications: A survey. *Expert Systems with Applications*, Vol. 42, 2015, pp. 7684 – 7697.
- [3] Atsalakis, G.S., Valavanis, K.P. Surveying stock market forecasting techniques part II: Soft computing methods. *Expert Systems with Applications*, Vol. 36, 2009, pp. 5932-5941.
- [4] Cavalcante, R.C., Brasileiro, R.C., Souza, V.L., Nobrega, J.P., and Oliveira, A.L. Computational intelligence and financial markets: A survey and future directions. *Expert Systems with Applications*, Vol. 55, 2016, pp. 194-211.
- [5] Chong, E., Han, C., Park, F.C. Deep learning networks for stock market analysis and prediction: Methodology, data representations, and case studies. *Expert Systems with Applications*, Vol. 83, 2017, pp. 187–205.
- [6] Fischer T., Krauss, C., Deep learning with long short-term memory networks for financial market predictions. *European Journal of Operational Research*, Vol. 270, No. 2, 2018, pp. 654-669.
- [7] Hiransha, M., Gopalakrishnan, E.A., Menon, V.K., Soman. K.P. NSE stock market prediction using deep-learning models. *Procedia Computer Science*, Vol. 132, 2018, pp. 1351–1362.
- [8] Nti, I.K., Adekoya, A.F., Weyori, B.A. A systematic review of fundamental and technical analysis of stock market predictions. *Artificial Intelligence Review*, 2019, pp. 1-51.
- [9] Radivojevic, N., Cvijetkovic, M., Stepanov, S. The new hybrid VaR approach based on EVT. *Estudios de Economia*, Vol. 43, No. 1,(2016), pp. 29-52
- [10] Radivojevic, N., Sabot-Matic, Z., and Mirjanic, B. New historical bootstrap value-at-risk model. *Journal of Risk Model Validation*, Vol. 11, No. 4, 2017, pp. 57-75.
- [11] Radivojević, N., Bojić, B., Lakićević, M. Measuring expected shortfall under semi-parametric expected shortfall approaches: a case study of selected Southern European/Mediterranean countries. *Journal of Operational Risk*, Vol. 14, No. 4, 2019, pp. 43-76.
- [12] Radivojevic, N., Filipovic, L., Brzakovic, T. A new Semiparametric Mirrored Historical Simulation Value at Risk model. *Romanian Journal of Economic Forecasting*, Vol. 23, No. 1, 2020, pp. 5-21.
- [13] Rockafellar R. T., Uryasev, S. P., Value at Risk vs. Conditional Value at Risk in Risk Management and Optimization, INFORMS, 2008.
- [14] Rundo, F., Trenta, F., di Stallo, A. L., and Battiato, S. Machine learning for quantitative finance applications: A survey. *Applied Sciences*, Vol. 9, No. 5574, 2019, pp. 1-20.
- [15] Shah, D., Isah, H., Zulkernine, F. Stock market analysis: A review and taxonomy of prediction techniques. *International Journal of Financial Studies*, Vol. 7, No. 2, 2019, 1-26.
- [16] Sezer, O.B., Gudelek, M.U., Ozbayoglu, A.M. Financial time series forecasting with deep learning: A systematic literature review: 2005-2019. *Intelligent Automation and Soft Computing*, Vol. 26, No. 2, 2020, pp. 323–334.
- [17] Thomaidis, N.S., Dounias, D.G., A comparison of statistical tests for the adequacy of a neural network regression model. *Quantitative Finance*, Vol. 12, No. 3, 2012, pp. 437-449.
- [18] Xing, F.Z., Cambria, E., Welsch, R.E. Natural language-based financial forecasting: a survey. *Artificial Intelligence Review*, Vol. 50, 2018, pp. 49–73.

- [19] Ziggel, D., Berens, T., Weiß, G.N.F. Wied, D. A New Set of Improved Value-at-Risk Backtests. Working Paper N°. 29, SFB, 2013.
- [20] Regin, R., Rajest, S. S., & Shynu, TA Review of Secure Neural Networks and Big Data Mining Applications in Financial Risk Assessment. Central Asian Journal of Innovations on Tourism Management and Finance, Vol. 4, No. 2, 2023, pp. 73-90.
- [21] Bi, W., Xu, B., Sun, X., Wang, Z., Shen, H., & Cheng, X. (Company-as-tribe: Company financial risk assessment on tribe-style graph with hierarchical graph neural networks. In Proceedings of the 28th ACM SIGKDD Conference on Knowledge Discovery and Data Mining, 2022, pp. 2712-2720).
- [22] Li, X., Wang, J., Yang, C. Risk prediction in financial management of listed companies based on optimized BP neural network under digital economy. Neural Computing and Applications, Vol. 35, No. 3, 2023, pp. 2045-2058.
- [23] Liu, Z., Du, G., Zhou, S., Lu, H., Ji, H. Analysis of internet financial risks based on deep learning and BP neural network. Computational Economics, Vol. 59, No. 4, 2022, pp. 1481-1499.
- [24] Li, J. (2022). An early control algorithm of Corporate financial risk using artificial neural networks. Mobile Information Systems, 2022.



## KNOWLEDGE MANAGEMENT AND INDUSTRY 4.0 TECHNOLOGIES – PRELIMINARY LITERATURE REVIEW

Jelena Slavić<sup>1</sup>, Željko Stojanov<sup>1</sup>

<sup>1</sup>University of Novi Sad, Technical Faculty "Mihajlo Pupin", Zrenjanin, Serbia

e-mail: [jelena.slavic@tfzr.rs](mailto:jelena.slavic@tfzr.rs), [zeljko.stojanov@uns.ac.rs](mailto:zeljko.stojanov@uns.ac.rs)

**Abstract:** With the development of industrial revolutions, technologies also developed significantly. Today, technological changes have a significant impact on knowledge management and industries that operate in the 4.0 environment. This paper aims to determine and analyze the leading technologies used in industries and their connection to knowledge management. The research was done through a preliminary review of the literature, where, after searching in scientific databases, ten primary studies were selected, presented and analyzed. Selected papers have conducted research through various methods on this topic in various industries around the world. Having contemporary technology enables organizations to manage knowledge more efficiently and better.

**Key words:** knowledge management, industry 4.0, technologies, literature review

### INTRODUCTION

Industry 4.0 (I4.0) has brought significant changes in terms of technology. There are numerous technologies, such as Internet of Things (IoT), Big Data, Cloud Computing, digital twin, and Additive Manufacturing [1]. Industry 4.0 is one of the next steps of the industrial revolution that can transform production flow and change the communication between humans and machines [2].

In the I4.0 era, one of the most essential items for the success of organizations is the concept of knowledge management (KM). Two fundamental aspects affect knowledge management [3]:

1. the resource-based view of the firm, which refers to how knowledge contributes to technological change and organizational knowledge,
2. the humanistic theory of management

Organizations depend on technology and software for their knowledge management projects, such as knowledge warehouses, knowledge bases, and expert systems. These enable and promote knowledge sharing and transfer between their members [4].

Industries equipped with advanced technology enable employees to perform their work more efficiently, leaving more time and space for other tasks, thus encouraging creativity that could only be expressed later. Managing knowledge is paramount for organizational survival and its effectiveness in environments that change fast and that are turbulent [5]. Maintaining knowledge management is essential, as intelligent machines, such as those using artificial intelligence (AI) and machine learning, are changing knowledge creation and sharing in organizations [6].

This work aims to research, present and analyze the technologies used in industries operating in the era of 4.0 that have a significant impact on knowledge management. This work is divided into several sections: related work, methodology, findings and conclusion with future work announcement.

### RELATED WORK

The related work section presents other literature reviews on the topic of knowledge management and technologies used in Industry 4.0. Ribeiro et al. [7], based on 41 selected



papers, point to technologies and their impact on knowledge as well as KM and employee engagement.

According to the structured literature review and bibliometric analysis, Machado et al. [8] provide an overview of KM and digital transformation, innovation ecosystem and frontier technologies. The analysis also provides a holistic view of KM and I4.0.

Capestro and Kinkel [9] conducted research through reviewed papers published in journals for business and management and analyzed the empirical studies. They found that Industry 4.0 is a knowledge-based approach, and it comes from using new technologies such as IoT, Big data, CyberPhysical systems, cloud, automation, etc. Also, they found that using KM and I4.0 technologies improves business processes, products and services.

Dragicevic et al. [10] found and explained the lack of literature regarding knowledge dynamics in Industry 4.0. They proposed a theoretical model with three layers – physical, virtual and interface of knowledge dynamics, and showed how big data analytics is just one part of the values of big data.

## LITERATURE REVIEW METHODOLOGY

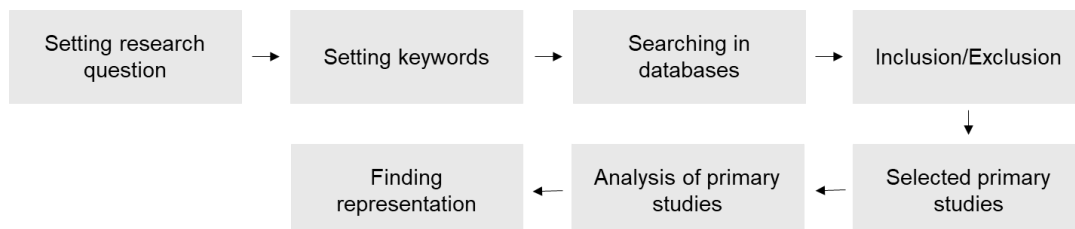
This work was done through a preliminary literature review. A research question was drawn based on the considerations in the introduction section.

**RQ:** What are the main technologies used for knowledge management in Industry 4.0?

The literature search was done by defining keywords based on the research question; in addition, the snowball literature searching technique was also used, which refers to the use of a list of work references or citations in the work to identify additional works [11].

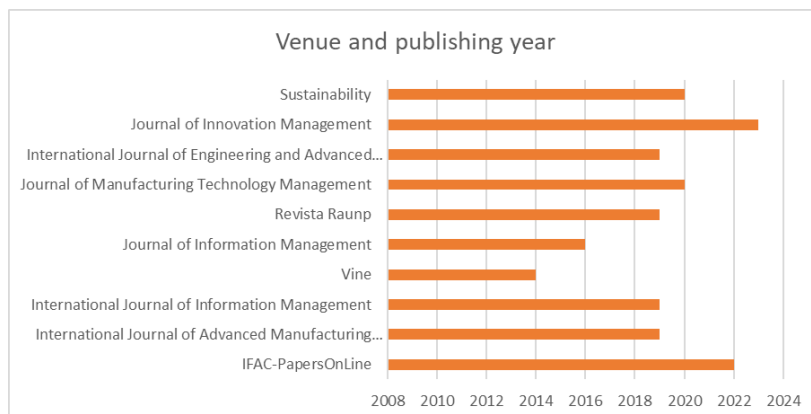
String: "knowledge management" AND "industry 4.0 technologies"

The literature search was performed in Google Scholar, Science Direct, Research Gate and Taylor & Francis databases. Figure 1 shows the schematic presentation of the research methodology implemented in this paper.



**Fig. 1.** Schematic presentation of the research methodology

Figure 2 shows the names of the journals and conferences in which the analyzed papers are found by year.



**Fig. 2.** Presentation of venue and year of the papers

In order to perform a better review of the literature, specific criteria were set and followed before the final list of selected primary studies (PS) was drawn up. These criteria are known as Inclusion/Exclusion criteria, which are necessary for the selection of primary studies that are suitable for further analysis.

Inclusion:

1. Paper is written in English
2. Paper directly addresses KM and I4.0 technologies

Exclusion:

1. Paper was not published in refereed journal and conference.
2. Paper is literature review
3. Paper was published before 2010.

The analysed papers carried out research related to KM and I4.0 technologies through questionnaires and interviews in the domains of manufacturing, telecommunication, jewellery and automotive industries. After selection by Inclusion/Exclusion, Table 1. shows the ten selected primary studies (PS) that were analyzed in more detail based on the proposed research question.

**Table 1. List of primary studies**

<b>Primary studies</b>	<b>References</b>
PS1	Lista, A. P., & Tortorella, G. L. (2022). Integration of Industry 4.0 technologies and Knowledge Management Systems for Operational Performance improvement. <i>IFAC-PapersOnLine</i> , 55(10), 2042-2047.
PS2	Li, D., Fast-Berglund, Å., & Paulin, D. (2019). Current and future Industry 4.0 capabilities for information and knowledge sharing: Case of two Swedish SMEs. <i>The International Journal of Advanced Manufacturing Technology</i> , 105, 3951-3963.
PS3	Ghouri, A. M., & Mani, V. (2019). Role of real-time information-sharing through SaaS: An industry 4.0 perspective. <i>International Journal of Information Management</i> , 49, 301-315.
PS4	Shafiei Nikabadi, M. (2014). A framework for technology-based factors for knowledge management in supply chain of auto industry. <i>Vine</i> , 44(3), 375-393.
PS5	Mao, H., Liu, S., Zhang, J., & Deng, Z. (2016). Information technology resource, knowledge management capability, and competitive advantage: The moderating role of resource commitment. <i>International Journal of Information Management</i> , 36(6), 1062-1074.
PS6	Brizolla, R. K., Patias, T. Z., & DORION, E. C. H. (2019). The understanding and the implementation of Industry 4.0: an exploratory Study of a Brazilian metal-mechanic SME. RAUnP-ISSN 1984-4204-Digital Object Identifier (DOI): <a href="http://dx.doi.org/10.21714/raunp.11(2).5-20">http://dx.doi.org/10.21714/raunp.11(2).5-20</a> .
PS7	Cimini, C., Boffelli, A., Lagorio, A., Kalchschmidt, M., & Pinto, R. (2020). How do industry 4.0 technologies influence organisational change? An empirical analysis of Italian SMEs. <i>Journal of Manufacturing Technology Management</i> , 32(3), 695-721.
PS8	Librita Arifiani, S. K., Dyah Budiastuti, M. M., & Wibowo Kosasih, E. (2019). The effect of disruption technology, and the future knowledge management toward service

	innovation for telecommunication industry 4.0 in Indonesia. <i>Int. J. Eng. Adv. Technol</i> , 8, 247-257.
PS9	Bettiol, M., Capestro, M., Di Maria, E., & Grandinetti, R. (2023). Leveraging on intra-and inter-organizational collaboration in Industry 4.0 adoption for knowledge creation and innovation. <i>European Journal of Innovation Management</i> , 26(7), 328-352.
PS10	Castagna, F., Centobelli, P., Cerchione, R., Esposito, E., Oropallo, E., & Passaro, R. (2020). Customer knowledge management in SMEs facing digital transformation. <i>Sustainability</i> , 12 (9), 3899.

## FINDINGS

Table 2. provides a list of technologies (T) used in Industry 4.0 that affect knowledge management.

**Table 2.** List of analysed I4.0 technologies

T	Analysed I4.0 technologies	PS
T1	Cyber-physical systems	PS1
T2	Internet of Things	PS1, PS4, PS6, PS9
T3	Big Data	PS1, PS6, PS8, PS9
T4	Cloud computing	PS1, PS2, PS6, PS9
T5	Automation	PS1, PS6, PS7, PS9
T6	SaaS and RTIS technologies	PS3
T7	Data analysis	PS4
T8	Content management system	PS4
T9	Database	PS4
T10	Electronic bulletins	PS4
T11	Organizational portals	PS4
T12	Video and teleconferencing	PS4
T13	Group wares or public software	PS4
T14	Expert systems	PS4
T15	IT resources (IT infrastructure, IT human, and IT relationship)	PS5
T16	Decision support systems	PS4, PS6, PS7
T17	Relation, marketing and search optimisation tools	PS10

In [PS1], the authors explore KM as a mediator between I4.0 technologies and operational performance. The significance of the positive influence between KM and I4.0 technologies was confirmed through regression analysis. T1 uses the cyber-physical systems that the authors in [PS1] addressed. T2 is located in [PS1][PS4][PS6] and [PS9] studies, where IoT is one of today's most important technologies. According to the [PS6], IoT will allow field devices to communicate with each other and more centralized controllers as needed.

The authors in [PS1][PS6][PS8] and [PS9] explore the impact of using Big Data technologies, T3, and knowledge management on competitive advantage. Also, in addition to T2 and T3, T4 include the most significant number of primary studies that use cloud computing concerning KM. T5, identified in studies [PS1][PS6][PS7][PS9], includes many technologies such as artificial intelligence, robotics, additive manufacturing, virtual reality, 3D, laser cutting, and more used in research and development of impact on KM. Technology, such as intelligent machines and robotics, are the first technologies in which most companies invest, integrating new, easily programmable machines, according to the result of [PS7]. As [PS9] indicate, I4.0

technologies may create new knowledge for the innovation of processes and products within the manufacturing context.

Through SaaS technology, [PS3] deals with real-time information sharing (RTIS) with customers. From T7 to T14, PS4 includes an enormous number of used technologies to investigate technology-based factors for knowledge management in the supply chain in the car industry.

T15 refers to information technologies - IT infrastructure, IT human, and IT relationship that the authors used for their research in [PS5]. [PS10] focuses on T17 - relation, marketing and search optimisation tools.

## CONCLUSION

This paper presents the preliminary research of technologies that have an impact on KM in Industry 4.0. The findings of this paper indicate that today, many industries, from manufacturing to the wholesale and retail sectors, use various contemporary technologies that significantly impact knowledge management. This indicates that technologies such as robotics, IoT, artificial intelligence and many other digital technologies are an inevitable part of today's business. This work encounters certain constraints that can affect the quality of the research, like the number of selected primary studies.

The following research could consider a larger sample of studies from more digital databases by following guidelines for systematic literature reviews that result in more reliable findings. In addition, conducting an empirical study in industries operating in the territory of Serbia is another research direction.

## REFERENCES

- [1] Hines, P., Tortorella, G. L., Jiju, A., Romero, D., Industry 4.0: Clustering of concepts and characteristics, *Cogent Engineering*, vol. 30, pp. 64-68, 2023.
- [2] Rai, R., Tiwari, M. K., Ivanov, D., Dolgui, A., Machine learning in manufacturing and industry 4.0 applications, *International Journal of Production Research*, vol. 59, pp. 4773-4778, 2021.
- [3] Al-tit, A. A., Al-ayed, S., Alhammadi, A., Hunitie, M., Alsarayreh, A., Albassam, W., The impact of employee development practices on human capital and social capital: the mediating contribution of knowledge management, *Journal of open innovation: Technology, market and complexity*, vol. 8, 2022.
- [4] Maravilhas, S., Martins, J., Strategic knowledge management in a digital environment: Tacit and explicit knowledge in Fab Labs, *Journal of business research*, vol. 94, pp. 353-359, 2019.
- [5] Yates, D., Paquette S., Emergency knowledge management and social media technologies: A case study of the 2010 Haitian earthquake, *International Journal of Information Management*, vol. 31, pp. 6-13, 2010.
- [6] Jarrahi, H. M., Askay, D., Eshraghi, A., Smith, P., Artificial intelligence and knowledge management: A partnership between human and AI, *Journal business horizon*, vol. 66, pp. 87-99, 2023.
- [7] Ribeiro, V. B., Nakano, D., Muniz Jr, J., & Oliveira, R. B. D., Knowledge management and Industry 4.0: a critical analysis and future agenda, *Gestão & Produção*, vol. 29, 2022.
- [8] Machado, D. B., A., Secinaro, S., Calandra, D., Lanzalunga, F., Knowledge management and digital transformation for Industry 4.0: a structured literature review. *Knowledge Management Research & Practice*, vol. 20(2), pp. 320-338, 2022.
- [9] Capestro, M., Kinkel, S., Industry 4.0 and knowledge management: A review of empirical studies. *Knowledge Management and Industry 4.0: New Paradigms for Value Creation*, pp. 19-52, 2020.

- [10] Dragicevic, N., Ullrich, A., Tsui, E., Gronau, N., A conceptual model of knowledge dynamics in the industry 4.0 smart grid scenario. *Knowledge Management Research & Practice.*, 2019.
- [11] Wohlin, C., Guidelines for snowballing in systematic literature studies and a replication in software engineering, *Proceedings of the 18th international conference on evaluation and assessment in software engineering*, pp. 1-10, 2014.



## INVESTIGATING THE IMPLEMENTATION OF INTEGRATED MANAGEMENT SYSTEM (IMS)

Aleksandra Šučurović<sup>1</sup>, Jelena Kiurski Milošević<sup>1</sup>, Eleonora Terečik<sup>1</sup>

<sup>1</sup> Technical College of Applied Sciences in Zrenjanin, Serbia

e-mail: [aleksandra.sucurovic@vts-zr.edu.rs](mailto:aleksandra.sucurovic@vts-zr.edu.rs)

**Abstract:** In order to sustain their business, companies must balance the fulfilment of requirements of all the parties involved. Their attempts to achieve sustainability rely on numerous international standards, but also on integrated management system which integrates all the elements of a business system (through better quality, improvements in environmental protection, data protection, etc.) into a unique and complete production management system in an organization so that the requirements of all the interested parties could be fulfilled and the business objectives achieved. The results of a survey conducted with the aim of investigating the importance of implementation of IMS in the companies which perform various kinds of sectors and industries are presented in this paper. The obtained results indicate a high level of implementation of different standards, obtained benefits, as well as a high level of the employees' awareness of the need to apply them.

**Key words:** integrated management system (IMS), ISO standards, survey

### INTRODUCTION

The effort put in advancing the competitiveness of a company in the local and international market has never been a simple task because it involves extreme commitment and responsibility [1]. Competitiveness involves the implementation of different development programs, an integrated management system (IMS) based on ISO standards, innovations in new products and services always with same the aim [2]: to offer quality products, to provide continuing growth, to improve operations, as well as to ensure permanent adjustment of business strategy to market demands. ISO standards constantly have affected the increase of competitiveness of products and companies since the first standard was introduced in the 1990s of the 20<sup>th</sup> century (series ISO 9000), with all the reviews made so far (ISO 9001, 9004, 14001, OHSAS 18000, ISO 27000) along with the development of the new ones (OHSAS 18001, ISO 22000, ISO 27001, ISO 26000, ISO 45001, ISO 50001) [3]. On the other hand, ISO standards create scientific and technological basis for making legislative, health, safety and environmental frameworks at the state level [4,5,6]. Due to ISO standards and the use of practical models, we have a possibility to solve many everyday problems we face, from global management of water resources to improvement of food safety. It is a notorious fact that the application of ISO 9001 standard is voluntary, but companies are well aware of the importance of having a certificate of successful implementation of this standard. Unfortunately, examples of possessing this certificate just as a formality can always be found because the standard has not been properly implemented, hence, there are no appropriate effects resulting thereof. Therefore, it is necessary for all the employees, particularly the top management, to comprehend the significance of all principles, instructions and requirements of quality management system [5]. Application of the basic ISO 9001 standard is only the beginning. It is desirable for a company to implement other international standards as well, particularly those aiming at environmental protection [4,7]. The implementation of IMS ensures a more efficient realization of set goals and business activities for employers and employees, especially those related to quality (quality management system (QMS)), environmental protection (environmental management system (EMS)), safety and health at work (Occupational Health & Safety OHSAS), risk analysis, critical points control, etc.

(HCCP- Hazard analysis and Critical Control Point) [1]. Integrated management system implies permanent quality advancement in business in order to achieve business excellence of a modern organization.

## **RESEARCH METHODOLOGY**

### **Problem and subject of research**

It is a well-known fact that some companies do not possess the ISO certificate; on the other hand, some companies possess it, but just as a formality because the standard has not been properly implemented, and therefore there are no appropriate effects resulting from it. Also, the level of employees' awareness of the importance of implementing various standards is not enviable. In order to verify the veracity of these claims, a survey was conducted, and the subject of the survey were companies from various production activities (glass processing, automotive industry, household chemicals, cosmetics, etc.), as well as from an agency in the field of providing certification and consulting services.

### **Research objective**

The goal of the investigation was to determine the importance of the implementation of IMS. The obtained results of the investigation indicated the level of awareness of the employees regarding the following: the importance of application of various standards, fulfilment of requirements of different regulations, importance of establishment of quality policy which ensures further definition of quality objectives, re-examination and the method which may be used to improve the quality and environmental policy which should comply with the mission and vision of the company. This investigation shows the real mindset of the employees regarding fulfilment of the requirements of the implemented standards as well as their desire and awareness of possible improvements in effectiveness of the integrated management system.

### **Research instrument**

The employees were asked to fill out the survey containing the questions formulated in such a way so that no confidential information is disclosed while at the same time respondents give responses to the questions within given topics.

### **Research questions**

Questions are formulated to obtain information about the number and type of implemented standards, benefits and improvements observed in the production processes upon their implementation, about advancement in environmental protection, realization of internal and external audits/controls, as well as about the awareness of employees of certain implemented standards in companies which perform various kinds of activities.

### **Research sample**

The survey was conducted in several companies in different industries. The target group were the employees whose positions include an active or passive participation in implementation of various standards. In case the positions of respondents were not directly related to management of standards, the condition was that they were familiarized with the details of the manner in which IMS is implemented in the company they work for.

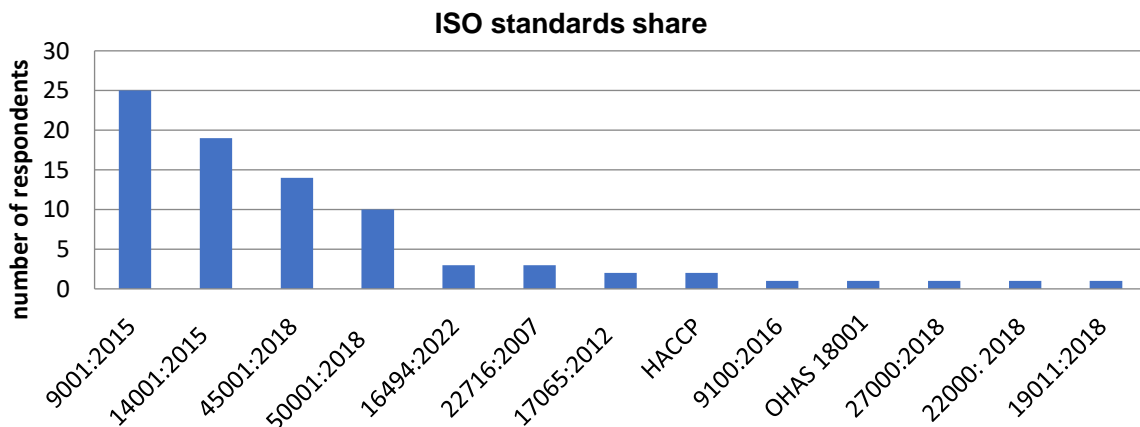


## RESULTS AND DISCUSSION

The survey comprised the total of 30 respondents from 12 different sectors. Most of respondents were from glass production and glass processing – 10 of them from different division so that a wide range of answers could be given from multiple point of view with a valid outcome in compliance with the intention of the survey investigator. There were 4 respondents from automotive industry, 3 respondents from each certification services and consulting services and 3 respondents from both household chemicals and cosmetic product manufacturers. Fewer respondents were from technical examination and analysis as well as from food industry, while the fewest were the respondents from agricultural production, distillation equipment production, road reconstruction, non-metal production, utility services and machine metal processing.

Most of respondents were from quality assurance departments, seven of them, followed by six respondents employed in human resources departments among whom were employees responsible for safety at work and environmental protection. There were 5 respondents from maintenance departments and 3 process engineers, while 3 chemical and cosmetic technologists also took part in the survey. The same number of employees responsible for the certification of ISO standards as technologists took part in the survey and also one respondent from each information technology and logistics and one project manager.

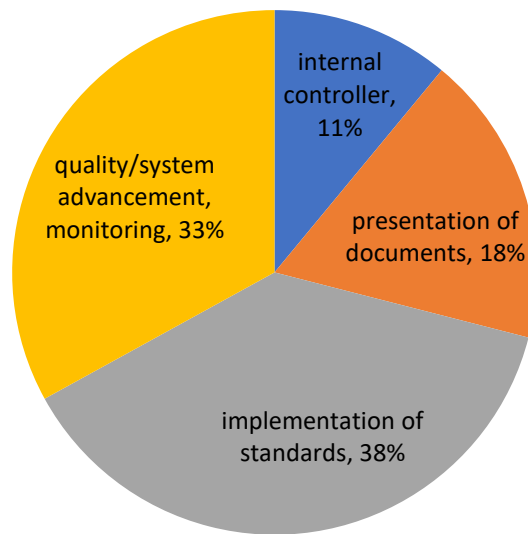
To the question as to which of ISO standards were implemented in their company, most respondents answered ISO 9001, which is shown in Figure 1.



**Fig. 1.** ISO standards share in analysed companies

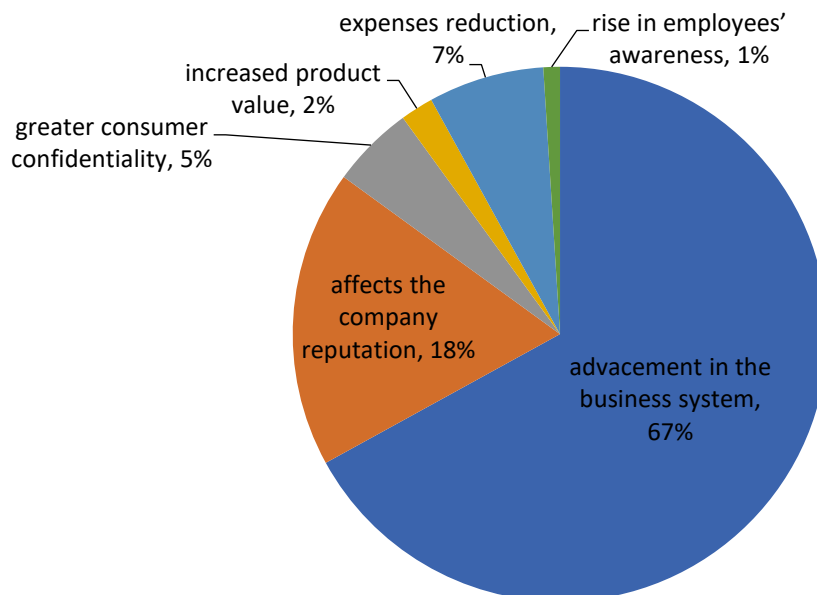
The work tasks of the respondents from quality assurance departments are mainly related to ISO standard 9001:2015 and they are the most numerous; human resources departments mostly deal with standards focused on environmental issues (ISO 14001:2015 and ISO 45001:2018), while the respondents working in maintenance departments or engineers mostly deal with 50001:2018 standard related to energy management.

The work tasks and duties of the respondents within ISO standards are mostly related to implementation of standards and quality or system advancement which involve monitoring as well. Fewer respondents are in charge of documents presentation to auditors, while seven respondents perform the duties of internal controller once or twice a year (Figure 2).



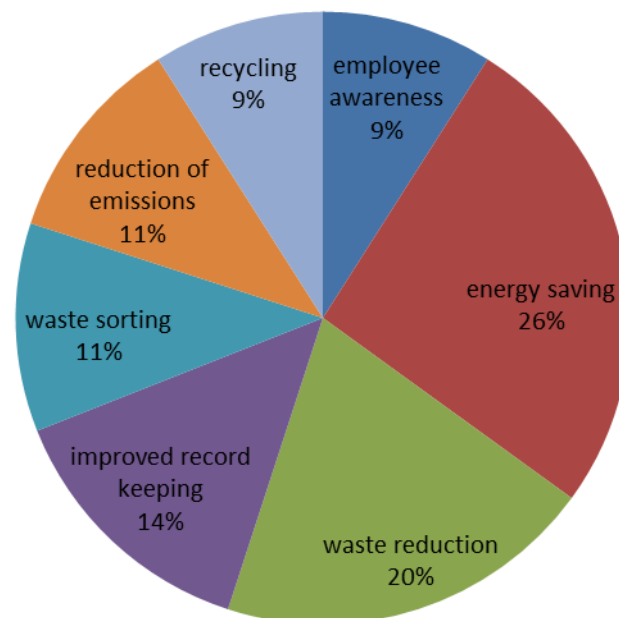
**Fig. 2.** Type of work at the position related to ISO standard

When responding to the question as to whether they thought that the implementation of certain ISO standards could provide benefits to the company, the respondents were asked to give at least two benefits if their answer was positive. Most respondents cited advancement in the business system, which mainly comprised quality, organization of work, comprehensive view of documentation and efficiency (67%). As shown in Figure 3, 18% or 11 respondents agreed that implementation of ISO standards affected the company reputation. Less than 10% of respondents believed that the implementation could result in other benefits such as: consumer confidentiality, expenses reduction, increased product value and rise in employees' awareness, which were all legitimate and accurate answers.



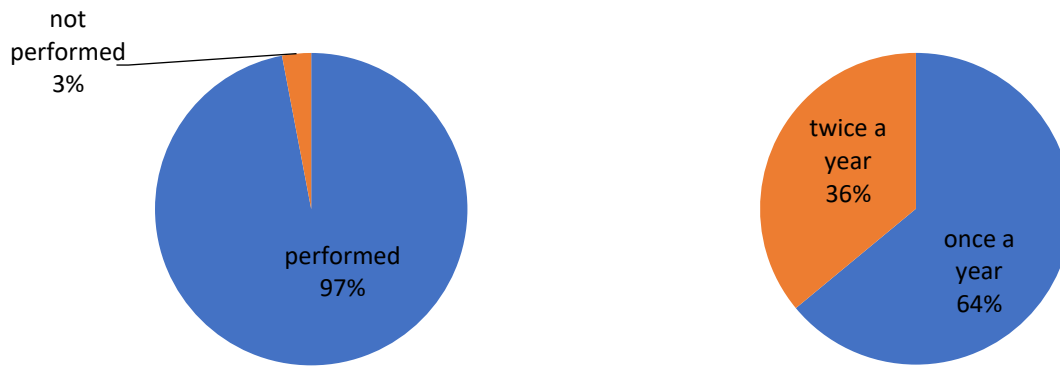
**Fig. 3.** Possible positive benefits of ISO standards implementation

The next question was about the perceived improvements in the production process due to the implementation of ISO standards related to product quality. The respondents mentioned several improvements in the quality of the products which they believed were made due to the implementation of ISO standards; however, they underlined that the greatest effect could be perceived in advancement of the product traceability, from the point where the material entered the manufacturing, until the point where the finished product left the company. One respondent from each group answered that the implementation of standards could also affect the increase in production capacity as well as more qualitative services offered to customers. The respondents from the companies which had applied ISO 14001 standard noticed a lot of benefits (Figure 4). However, a lot of respondents, 10 of them, admitted that ISO 14001 standard had not been applied in their companies, which makes up 33.33% of the total number of respondents. Accordingly, the percentages were calculated and presented based on the answers of the remaining 20 respondents who mentioned at least two benefits which they considered derived from the implementation of this standard. Most respondents said that the implementation of the standards focused on environmental issues could contribute to energy saving and reduction of waste. To the question as to which sectors should apply ISO 14001 standard, about 70% of respondents named a large number of companies which, owing to the fact that they are manufacturing companies, generated waste and were considered big or small polluters. Nevertheless, other respondents were resolute regarding industry or sector which should implement this standard. As one reason for the implementation of ISO standards they cited environmental protection and safety of all those found in the work or life environment. Although 10 respondents did not have ISO 14001 standard implemented in their companies, all of them answered this question, which undoubtedly shows that there is awareness of the need to apply this standard. However, two respondents answered that no sector should implement this standard without stating any reason for their opinion.



**Fig. 4.** Perceived benefits of application of ISO 14001 standard

As much as 97% of respondents said that internal and external audits/controls of ISO standards were performed in the companies they worked for, while only 3% of them answered negatively to this question. In most cases audits were performed once a year as per answers of two thirds of respondents (Figure 5)



**Fig. 5.** Are controls/audits conducted and how many times per year?

Is it important for all employees in the company to be informed that the company has ISO standards implemented or only those employees whose tasks are related to ISO standards? – this was the question which followed. The majority of respondents, 90% of them said that all employees should be informed, while the rest of them thought that only those employees whose tasks were related to ISO standards should be informed. One part of respondents said that not more than 30% of their co-workers were informed about the implementation of the standards in their company; the other part of respondents thought that this number was somewhere between 51% and 70% of their colleagues, while the largest number of respondents believed that 71-100% of their colleagues were informed about the standards. Although a larger number of respondents was of that opinion, a part of them also said that their colleagues were ill-informed about the manner in which the standard was implemented. Two respondents could not give their opinion about this question.

Finally, the last question in the survey was hypothetical: if they were the owners of the company they worked for, whether they would initiate implementation of ISO standards. There were 97% of positive answers although a part of respondents was not entirely familiarized with those standards which were not implemented in their company or the standards were not related to their assigned tasks. Only one respondent was not interested in application of standards in "his company" if he was to assume the role of a manager or owner.

## CONCLUSION

After a detailed consideration of the respondents' answers and the analysis of IMS functioning in different companies, it can be concluded that it is necessary for every production to implement at least one ISO standard so it could be competitive in the market. Although the majority of respondents hold positions related to ISO standard 9001 in the quality assurance departments, 90% of them do not consider ISO 14001 standard less important and believe that it should be implemented in all sectors considered bigger or smaller polluters. The majority of respondents agree that the implementation of the standards may considerably contribute to the company's reputation and advancement of the business system, while the employer has a duty to recognize and realize this need. The answers offer the conclusion that the respondents are well aware of the need to implement ISO standards, although entrepreneurs must be continuously informed about the quality, IMS, business excellence and the similar.

## REFERENCES

- [1] Đorđević, D., Bogetić, S., Primena integrisanih menadžment sistema u malim i srednjim preduzećima, *Industrija* 4, pp. 95-107, 2007.
- [2] Rajković, D., Integrisani sistemi menadžmenta u malim i srednjim preduzećima, doktorska disertacija, Univerzitet u Kragujevcu, Mašinski fakultet u Kragujevcu, Kragujevac, 2010.
- [3] Internet source: ISO website: <https://iso.org.rs/iso-medunardna-organizacija-za-standardizaciju/>
- [4] Živković, N., Integrisani sistemi menadžmenta, Fakultet organizacionih nauka univerziteta u Beograd, 2012.
- [5] Babić, J., Značaj primene međunarodnih ISO standarda za upravljanje preduzećem i obezbeđivanje satisfakcije potrošača, *Marketing*, pp. 180-188, 2011.
- [6] Milutinović, D., Upravljanje totalnim kvalitetom kao osnova modela poslovne izvrsnosti savremene organizacije – isustva apotekarskih organizacija u republici Srbiji, doktorska disertacija, Univerzitet Edukons, Fakultet poslovne ekonomije, Sremska Kamenica 2016.
- [7] Oruc, M., Muhamedagić, S., Borić, J., Agić, D., Značaj i promene standard ISO 14001, 10. Naučno-stručni skup sa međunarodnim učešćem "QUALITY 2017", Neum, 2017.



## REUSE CENTER LOCATION SELECTION

Ali Reza Afshari<sup>1</sup>, Abdolhossein Sadrnia<sup>2</sup>

<sup>1</sup>Islamic Azad University, Department of Industrial Engineering, Shirvan Branch,  
Shirvan, Iran.

<sup>2</sup>Department of Industrial Engineering, Quchan University of Technology, P.O. Box:  
94771-67335, Quchan, Iran.

e-mail:[afshari@mshdiau.ac.ir](mailto:afshari@mshdiau.ac.ir)

**Abstract:** Reuse as second most preferable way to minimize Municipal Solid Waste (MSW) is being encouraged to recover valuable resources before throw out to the landfill. Reuse centers, as most commonly infrastructure for effective reuse strategy, should be located properly. Effective and proper evaluation for reuse center selection may accelerate the implementation of sustainable conservation. This study presents a comprehensive methodology for the reuse center selection, using Delphi method and fuzzy linguistic evaluation. The criteria, which are relevant to the reuse selection, have been elicited through Delphi method and used to construct a Fuzzy decision making model. The model tested on a case study of reuse center location selection in Mashhad, Iran and it was proven feasible in real world applications. This approach also enables decision-makers to understand the complex relationships of the relevant attributes in reuse selection problems, which may subsequently improve the acceptability of the decision.

**Key words:** Waste Management; Reverse Logistics; Municipal Solid Waste; Reuse; Delphi method; Fuzzy linguistic decision-making.

### INTRODUCTION

Reverse logistics (RL) has become a main part of green logistics due to its contribution in reducing the waste generated through several recovery activities such as reuse, remanufacturing and recycling [1]. RL processes have been explained by many authors in different perspectives. The used or returned products are collected after their acquisition and inspected for sorting into the different categories. The next step is to dispose them for repair, remanufacturing, recycling, reuse or final disposal depending on the decision taken to either recapture value or dispose of it. Reducing, reusing and recycling are important because they decrease the amount of waste on the planet and preserve natural resources by maintaining space and cutting down on landfills. Reducing, reusing and recycling reduce consumption of new materials and save energy [2]. Reuse is a means to prevent solid waste from entering the landfill, improve our communities, and increase the material, educational and occupational wellbeing of our citizens by taking useful products discarded by those who no longer want them and providing them to those who do. In many cases, reuse supports local community and social programs while providing donating businesses with tax benefits and reduced disposal fees. When reusing materials, instead of creating new products from virgin materials, there are fewer burdens on the economy. Reuse is an economical way for people of all socio-economic circles to acquire the items they need [3].

Previously, different types of models and methods developed for strategic decisions in reusable networks for different types of products. (In past, different types of models and methodologies have developed for strategic decisions in reuse networks for different categories of products.) Reuse network models include the models based on cost evaluation, and operational effectiveness. The solution methodologies include mathematical, stochastic, simulation, and MCDM. Recently, in a literature review, Agrawal et al. [2] observed that there are very few studies focusing on the disposition decisions in reverse logistics. It is also evident from the recent comprehensive review of reverse logistics articles by Govindan et al.

[4]. In the other hand, although many studies have talked about reuse by researches, a model for optimize the best location and prioritize reuse locations, not yet reached.

Reuse centers facilitate the transaction and redistribution of unwanted, yet perfectly usable, materials and equipment from one entity to another [5]. The entities that benefit from either side of this service (as donors, sellers, recipients, or buyers) can be businesses, nonprofits, schools, community groups, and individuals. Some maintain a physical space (a reuse center), and others act as a matching service (a virtual exchange). Reuse centers generally maintain both warehouses and trucks. They take possession of the donated materials and make them available for redistribution or sale. Virtual exchanges do not have physical space or trucks, but instead allow users to post listings of materials available and wanted on an online materials exchange website. Staff will help facilitate the exchange of these materials without ever taking possession of the materials. The focus of this research is on RL networks. This research work helps in achieving the goals, as follows:

- To identify, finalize and evaluate the reuse center selection criteria.

## **MATERIAL AND METHODS**

### **Location selection models and Reverse Logistics**

In past, different types of models and methodologies have been developed for strategic decisions in RL networks for different categories of products [2]. Caruso et al. [6] developed a location-allocation model to determine the number and locations of the waste disposal plants in the region of Lombardy (Italy). Kroon and Vrijens [7] explores different network design alternatives and proposes an mixed integer programming model (MILP) plant location model for deciding where container depots should be located. They reported a case study for reusable transportation packages, considering a single level decentralized structure with timing of returns as an important element of uncertainty to determine the number of containers, the number of container depots, and their locations. Wang et al. [8] dealt with determining the optimal site locations of processing stations for paper and cardboard which formed the largest fraction of post-consumer and municipal solid waste in the state of Iowa. Flapper et al. (1997) develop a continuous location model for the design of a recycling network for European carpet waste. It estimated that 1.6 million tons of carpet waste were land filled in Europe in 1996. The objective of their study was to determine appropriate locations and capacities for regional recovery centers taking into account investment, processing and transportation costs. As in the other cited reuse infrastructure design applications, the deterministic modeling approach is very limited in its ability to account for inherent uncertainty. Building and iron production waste recycling, resource allocation, and planning are studied by Spengler et al. [9]. Similar to the approach presented in this paper, Spengler et al. [10] define a location/allocation model to determine the number, size and location of reclamation facilities and manufacturing plants. Sand recycling was addressed by Barros et al. [11]. This study reported a case study for the recycling of sand coming from construction waste for multi-level capacitated warehouse location problem. The model determined the optimal number, capacities, and locations of the depots and cleaning facilities. Louwes et al. [12] considered the design of a recycling network for carpet waste and proposed a continuous location model that used a linear approximation facility location problem. Krikke et al. [13] reported a mixed integer linear programming (MILP) model, for the returns, processing, and recovery of discarded copiers. Products taken back from the customers were stored at pre-determined locations and from there, routed via recovery processing facilities to the demand locations for determining the locations and capacities of the recovery facilities as well as the transportation links connecting various locations. Jayaraman et al. [14] developed a model to determine the location of distribution remanufacturing facilities, the transshipment, production, and stocking of the optimal quantities of the remanufactured products and cores. Bautista and Pereira [15] focused on selecting the locations of municipal waste collection points in Barcelona. Pati et al. [16] developed a mixed integer goal programming multi-objective model to determine the facility



location, route and flow of different varieties of recyclable waste paper. Lee and Dong [17] developed a two stage heuristic approach by decomposing the integrated design networks into a location allocation problem and a revised network flow problem. For the collection of ELVs in Mexico, a strategic network design was studied by Cruz-Rivera and Ertel [18]. Kara and Onut [19] proposed a stochastic programming model for paper industry to determine a long term strategy including optimal facility locations and optimal flow amounts for large scale RL network design problem under uncertainty. They considered optimal recycling, collection center locations, and optimal flow amounts between the nodes in a multi-facility environment. The authors aimed to determine optimal number and locations of collection sites in which take-back, depollution and dismantling operations performed. Krikke [20] Copier A decision framework for optimizing the combined disposition and location-transport decision. Gomes et al. [21] developed a MILP model for best location for electric and electronic waste recovery including waste sources, sorting centers and recycling facilities in Portuguese. Diabat et al. [22] developed a mixed integer non-linear programming for number and location of collection points, and centralized return centers with the maximum holding time (collection frequency). Schweiger and Sahamie [23] considered a combined continuous and discrete facility location problem and utilized a hybrid Tabu Search approach to develop the scenario based model for a paper manufacturer. Dai and Wang [24] developed a model for direct reuse reverse logistics center location by using stochastic simulation, genetic algorithm and linear programming. Dai and Wang [24] developed a model for direct reuse reverse logistics center location by using stochastic simulation, genetic algorithm and linear programming. Ardjmand et al. [25] developed a genetic algorithm based model for the location, and routing in facilities and disposal sites considering risk and transportation cost.

It has recognized that although there are many papers in the published literature on the optimization of the reverse logistics networks, only few of them concern facility location problem. In addition, based on the literature review, it is quite clear that few works carried out on the selection of reuse center location using decision-making tools. There is no literature, which finds the use of multi-criteria group decision-making problem in fuzzy environment for the selection of reuse center location. Hence, we proposed to use Delphi method for eliciting criteria, and Fuzzy evaluation for selecting the best location from among the list of reuse centers.

### **The Delphi method**

The Delphi technique is an approach used to gain consensus among a panel of experts [26]. This normally achieved through a series of rounds where information fed back to panel members using questionnaires. It has used extensively within social science research and is being increasingly employed by researchers. This popularity has meant that the technique has been adapted in various ways. This signals the need for a critical review of the Delphi as a robust and systematic approach to data collection. While there is a great volume of literature surrounding the 'Delphi', there is a dearth of papers critically analyzing the technique [27]. The Delphi technique could achieve consensus of subject matter experts without bringing them together face-to-face to establish future criteria for reuse center location selection [27]. The specific objectives of adopting Delphi method in this research were as follows:

1. Identifying criteria required for reuse center location selection.
2. Determining a consensus of criteria derived from the responses of the experts.

15 professionals served as the panel of experts for this study. The researcher contacted the potential panel members with a description of the study process with a panel member contact letter and an information sheet that stated that given the conditions provided, the completion and returning of the form to the researcher indicated consent to participate in the study. Potential panel members provided with researcher contact information to answer any questions and asked to return the consent to participate form. A descriptive design using a three-round modified Delphi survey used to meet the study objectives. The first survey

questionnaire explained the issue in general terms with examples and asked the panel members to provide input about the initial set of criteria. Responses from the first survey questionnaire grouped together through a factor analysis and returned to the panel members in the second round. Using the information gathered in Round 1, the panel member's value rated the input provided in importance, using a numerical scale. The researcher summarized the numerical data input provided for the second survey questionnaire using the mean or average rating as a measure of central tendency. Panel members used a five-point Likert-type scale to indicate their value ratings for importance. In each subsequent round, respondents asked review their original responses and either retain them or change them based on the rationale and mean scores of all the participants from the previous rounds. During the period of February to March 2017, a detailed survey developed by two members of the reuse center planning team, with input from the remainder of the team. Questions selected with the goal of gathering a broad array of selection criteria about each reuse center. Reuse centers selected for interview based on a combination of online research and successful reputation. From May through November 2017, interviews conducted with program managers or leaders, and sites visited, if applicable. The questions administered developed in order to discover successes and challenges within each criterion. The following information is a summary of the criteria collected during phone interviews and on-site visits. On a daily basis, reusable materials treated as waste and dropped off at the Mashhad Recycling and Solid Waste Center (MRSWC) tipping floor for transfer to and disposal in the landfill. Given the proper outlet, these items could be diverted from the waste stream for reuse. Employees at the facility cited commonly disposed items that included games, shoes, clothes, silverware and dishware, mattresses, cribs, living room furniture, and dining room tables. Because this large volume of materials observed in a period of four hours, and information gathered from employees, the surveyors led to believe that a sizeable volume of good quality, reusable materials brought to the center throughout the day.

## RESULTS

In the recent years, Municipal Solid Waste (MSW) has been one of the most important environmental concerns throughout regions of Iran. Sound MSW management for any area needs to be based on reliable data in which present the actual MSW condition in that area. In this study, the holy city of Mashhad intended as a study area. Mashhad is Iran's second largest metropolis and has over three million populations. The city has 13 municipal districts and the per capita municipal solid waste in the city of Mashhad in some areas up to twice the per capita country. Environmental policies Mashhad Municipality Waste Management Organization (WMO) require the establishment of centers for exchange and sales of durable goods with the ability to reuse (Reuse center) made. To validate the proposed model, a case study conducted in WMO. In the first phase, consider items such as furniture, wooden accessories and electrical appliances. According to merger of waste organization & Mashhad municipality motor service in the city council open session on 2010, and in order to implement the act 84 of municipality regulations, clause 5 article 71 of formation, duties & selecting law of the Islamic council of state and mayors approved on 1996; WMO statute consists of 5 chapters, 38 article & 42 footnotes & about 25 clauses were prepared & got approved by Ministry of Interior. In recent years, the proportion of construction materials being reclaimed and reused has been falling. The proportion of reusable materials being recycled or sent to landfill is now around 50 per cent higher than it was ten years ago. Reuse of goods and materials is the most efficient, environmentally friendly, and economically viable way to reduce the waste stream. Creating a convenient alternative to disposal in landfills and making used materials easily available to the community is the best way to encourage reuse.

**Criteria selection for Reuse centre:** The first step in the process is to develop a team of related people who have knowledge and experience in reuse including managers, architects, architectural historians, developers, owners, experts and contractors. The team should clearly define the objectives and expectations in reuse, then identify the potential reuse

alternatives. The purpose of this stage was to identify criteria required for reuse center location selection. Once identified, the study would use the results in an attempt to determine a consensus of future criteria utilizing the responses of the urban planning experts. Using the derivative of this study, the criteria identified, the Urban planning decision makers, could use the results to develop a model to guide critical decisions of the future reuse center locations. The Delphi panel consisted of 15 members who classified as Director of solid waste management; three expert in waste management sector Mashhad; Three members of Mashhad University of Medical Sciences, School of Environmental Health; Three members of the faculty State University Quchan; Three experts from Mashhad Municipality; and Two other expert from Mashhad solid waste management.

**Round One:** For the first round survey, the panel members asked to complete an open-ended survey questionnaire by listing criteria they believed was required for a successful reuse center location in the future. They also provided with the operational definitions for the study and asked to review the example of criteria. The panel members also instructed to feel free to use the examples provided and anything else they thought appropriate. Although the panel members provided with the above instructions, two of the panel members were still a small bit confused and needed a little more clarification about what being asked. Even though, there were only two panel members with questions, the researcher believed that all of the questions received shared with all panel members along with the answers. The sharing of panel member questions and the responses thought to enhance the general understanding of the study for all involved. In the first round survey questionnaire, the number of criteria provided by the panel members varied per panel member. The responses included a large number of duplications, but oftentimes had a slightly different rationale for inclusion on the listing. All panel member surveys accepted as submitted. The panel of experts provided 67 separate response items. Using a factor analysis, the responses eventually combined resulting in 24 individual criteria for the remaining two rounds. The criteria reduced to 24 in order to eliminate duplication and to provide for efficiencies in evaluating, analyzing, and reporting the data identified for each survey round. Round One criterion and their associated rationales displayed in Table 1.

*Table 1. Round One Survey Responses caption*

Criteria	Criteria for Reuse center selection	Reason for Selection
C1	Distance from entertainment centers	It is related to distance the potential location from entertainment centers
C2	Distance from shopping centers	It is related to distance the potential location from shopping centers
C3	Density of population	It is a measurement of population per unit area or unit volume
C4	Distance from highways	It is related to distance the potential location from highways
C5	Distance from Parks and gardens	It is related to distance the potential location from Parks and gardens
C6	land price	the criteria is related to price of each meter land
C7	Distance from the center of the second-hand goods	"Each municipal district
C8	Distance from recovering center	Distance from all kind of Religious Organizations (mosque and Holy shrine,...)
C9	Distance from second hand shopping	It is referred to the distance between the potential location for reuse center and other solid waste recovering center such as: recycling center , recycling collection center and second hand market

C10	The literacy level (social awareness) of citizens in the region	It is related to distance the potential location from second hand shopping
C11	Distance from Religious Organizations	Has potential to output second-hand durable goods. The criteria is related to distance from potential location from the second-hand goods output for each district"
C12	Road (Street) width	The criterion is refereed to development capability in the future (regarding to and use plan or zoning; regional development policies and infrastructure) for the nominated location for reuse center.
C13	Cultural aspect	Accessibly and ease if car parking is a nessecary for municipal services centers. The criterion related to this facility for the reuse center potential location.
C14	The capability of future development.	It is related to the level of literacy and social awareness and public awareness of people in the nominated reuse center
C15	The average of community age	The criteria is related to road and street width near the potential location for reuse center
C16	Residents participation	Since the kinds of MSW is different between poor and reach people, the criteria would referred to the issue
C17	The average of community income	Social behavior related to the MSW is different between elderly population and young people. This criteria is related to the average age of inhabitants municipal regions
C18	Easy to access	The criteria is related to the Residents participation in collaborative efforts with municipalities in the potential location for establishing reuse center
C19	Distance to other municipal service centers	Land use involves the management and modification of natural environment or wilderness into built environment such as settlements and commercial, park and so on. This criteria is referred to the Land-use suitability
C20	Land-use suitability	The architectural charm around the reuse center (Physical condition of the building; architectural character and evaluation and materials and decorations of the building)
C21	Ease of car parking and its availability	The strongest magnetic fields usually emitted from high voltage transmission lines — the power lines on the big, tall metal towers. The criteria is referred to the distance greave of the potential location to the high voltage transmission lines
C22	Distance from power transmission (high voltage) lines	In reality, there are unofficial shopping or centers that buy/sell second-hand goods. The criteria related to the distance greave of the potential location to the centers.
C23	Distance to other unofficial sites selling/buying second-hand goods	Municipal services or city services refer to basic services that residents of a city expect the city government to provide for them. the criteria consider average distance from the potential location of reuse center to the other municipal service center such as post office, the public library, schools, food inspection, fire department and police
C24	The architectural charm	The ability or right to approach, enter, exit and communicate with the reuse center

**Round Two:** In Round 2, the responses received from the panel members in Round 1 and after a factor analysis aggregated and returned to each panel member with the listing of criteria and a summary rationale statement generated from the survey results. The panel members provided with Importance and asked to complete each spreadsheet by independently value rating each response using the five-point Likert-type scale. 22 out of the 24 or 91.7% of criteria that would be considered consensus. Out of the 22 criteria considered consensus, 17 or 77.3%, C3, C4, C5, C17, C6, C7, C8, C9, C10, C11, C12, C14, C15, C18, C19, C20, and C21 received the highest rating of 100.0% with a 1 = Critical or 2 = Very Important value rating. The 22 criteria considered consensus along with the percentage ratings for each one displayed in Table 2. Table 2, also detailed the value ratings provided by the panel members' responses. The largest range of value ratings was C2 with a mean value rating of 2.7. C2 had a range value rating of two = Important to five = Very Unimportant. The highest mean value rating in this category was as also C2. The lowest mean value rating was 1.0. That distinction held by C4.

**Table 2.** Criteria Considered Consensus –Round Two (N=15)

Criteria	Responses	Percent	Mean	SD
Meeting Criteria				
C <sub>3</sub> : Density of population	15	100.0	1.1	0.35
C <sub>4</sub> : Distance from highways	15	100.0	1.0	0.00
C <sub>5</sub> : Distance from Parks and gardens	15	100.0	1.7	0.49
C <sub>6</sub> : land price	15	100.0	1.1	0.35
C <sub>7</sub> : Distance from the center of the second-hand goods	15	100.0	1.7	0.49
C <sub>8</sub> : Distance from recovering center	15	100.0	1.7	0.49
C <sub>9</sub> : Distance from second hand shopping	15	100.0	1.7	0.49
C <sub>10</sub> : The literacy level (social awareness ) of citizens in the region	15	100.0	1.3	0.46
C <sub>12</sub> : Road (Street) width	15	100.0	1.6	0.51
C <sub>14</sub> : The capability of future development.	15	100.0	1.8	0.41
C <sub>15</sub> : The average of community age	15	100.0	1.6	0.51
C <sub>17</sub> : The average of community income	15	100.0	2.0	0.53
C <sub>18</sub> : Easy to access	15	100.0	1.6	0.51
C <sub>19</sub> : Distance to other municipal service centers	15	100.0	1.3	0.49
C <sub>20</sub> : Land-use suitability	15	100.0	1.1	0.35
C <sub>21</sub> : Ease of car parking and its availability	15	100.0	1.9	0.26
C <sub>12</sub> : Road (Street) width	15	100.0	1.6	0.51
C <sub>13</sub> : Cultural aspect	13	86.7	2.0	0.53
C <sub>22</sub> : Distance from power transmission (high voltage) lines	13	86.7	2.0	0.53
C <sub>23</sub> : Distance to other unofficial sites selling/buying second-hand goods	13	86.7	1.9	0.64
C <sub>24</sub> : The architectural charm	11	73.3	2.1	0.64
C <sub>16</sub> : Residents participation	10	66.7	2.1	0.74
Not Meeting Criteria				
C <sub>2</sub> : Distance from shopping centers	7	46.7	2.7	0.82
C <sub>1</sub> : Distance from entertainment centers	6	40.0	2.6	0.51

**Round Three:** Round Three represented the last round for surveying the panel members. The statistics and any consensus generated in this round considered final input. In Round 3, all responses received from the panel members in Round 2 aggregated and returned to each panel member, with the listing of criteria and a summary rationale statement generated from the latest survey results. The panel members asked complete each spreadsheet by independently value rating each response using the five-point Likert-type scale. The WMO utility function Importance returned 23 out of the 24 or 95.8% of criteria that be considered consensus. Out of the 23 criteria considered consensus, 15 or 65.2%, C3, C4, C5, C6, C7, C8, C9, C10, C12, C14, C15, C18, C19, C20, and C21 received the highest rating of 100.0%

with a 1 = Critical or 2 = Very Important value rating. The 23 criteria considered consensus along with the percentage ratings for each one displayed in Table 1. Table 1, also detailed the value ratings as provided by the panel members. The largest range of value ratings was C2 with a mean of 2.2. C2 had range value rating of one = Very Important to five = Very Unimportant. The highest mean value rating was C1 with 2.47. The lowest mean value rating of 1.1 bestowed upon C4.

The WMO panel of experts returned 14 out of the 24 or 58.3% of attributes that be considered consensus. Out of the 14 attributes considered consensus, 7 or 50.0%, administrative theories, conflict resolution, decision-making, effective communication, effective discipline, ethical principles, and problem solving received the highest rating of 100.0% with a yes value rating. The 14 personal attributes and competency clusters considered consensus along with the percentage ratings for each one displayed in Table 3.

**Table 3. Criteria Consensus – Round Three (N=15)**

Criteria	Responses	Percent	Mean	SD	Required for Hire		
					n	Percent	
Meeting Criteria							
C3: Density of population	15	100.0	1.2	0.41	15	100.0	Yes
C4: Distance from highways	15	100.0	1.1	0.26	15	100.0	Yes
C5: Distance from Parks and gardens	15	100.0	1.7	0.49			
C6: Land price	15	100.0	1.3	0.46	15	100.0	Yes
C7: Distance from the center of the second-hand goods	15	100.0	1.6	0.63	15	100.0	Yes
C8: Distance from recovering center	15	100.0	1.5	0.52	14	93.3	Yes
C9: Distance from second hand shopping	15	100.0	1.7	0.72	14	93.3	Yes
C10: The literacy level (social awareness ) of citizens in the region	15	100.0	1.1	0.35	15	100.0	Yes
C12: Road (Street) width	15	100.0	1.9	0.64			
C14: The capability of future development	15	100.0	1.7	0.49	12	80.0	Yes
C15: The average of community age	15	100.0	1.7	0.62	14	93.3	Yes
C17: The average of community income	13	86.7	1.7	0.46	14	93.3	Yes
C18: Easy to access	15	100.0	1.3	0.49	14	93.3	Yes
C19: Distance to other municipal service centers	15	100.0	1.7	0.46			
C20: Land-use suitability	15	100.0	1.2	0.41	15	100.0	Yes
C21: Ease of car parking and its availability	15	100.0	2.2	0.41	13	100.0	Yes
C11: Distance from Religious Organizations	14	93.3	2.3	0.46			
C12: Road (Street) width	15	100.0	1.9	0.64			
C13: Cultural aspect	13	86.7	1.8	0.68	14	93.3	Yes
C22: Distance from power transmission (high voltage) lines	13	86.7	2.2	0.56			
C23: Distance to other unofficial sites selling/buying second-hand goods	13	86.7	1.9	0.59			
C2: Distance from shopping centers	12	80.0	2.2	0.94			
C24: The architectural charm	11	73.3	2.3	0.70			
C16: Residents participation	10	66.7	1.9	0.35			
Not Meeting Criteria							
C1: Distance from entertainment centers	8	53.3	2.5	0.74			

The 14 criteria identified and considered consensus in the category of WMO required for utility function considered the minimum entry-level requirements for the location of the future reuse center location selection. This would suggest the remaining criteria acquired after decision for optimal location. Moreover, if the location candidate possessed more than the 14

minimum entry-level requirements for the location, this would suggest an even better location for selection.

## CONCLUSION

The major contribution of this paper lies in the development of a comprehensive methodology, which incorporates issues for the selection of an optimal reuse location. The study contributes to the limited literature available for the disposition decision-making in reverse logistics. This research may help professional teams identify criteria that need to consider in reuse center selection. Results of an extensive case study for a reuse center selection also presented in the present paper. The outcomes of the case study have shown that the proposed model is useful, easy to understand/apply and provides useful results that are acceptable by the WMO experts. We believe that the proposed model addressed in the present paper be applied in wide variety of decision-making problems, where the intangibles and decision makers' perceptions have pivotal role on the outcome. One direction for the future research would be to apply some other Fuzzy-MADM methods such as Fuzzy-TOPSIS or Fuzzy-DEMATEL and compare the results of them with our results.

## REFERENCES

- [1] A. H. Vahabzadeh, A. Asiaei, and S. Zailani, "Green decision-making model in reverse logistics using FUZZY-VIKOR method," *Resources, Conservation and Recycling*, vol. 103, pp. 125-138, 2015.
- [2] S. Agrawal, R. K. Singh, and Q. Murtaza, "A literature review and perspectives in reverse logistics," *Resources, Conservation and Recycling*, vol. 97, pp. 76-92, 2015.
- [3] M. Fleischmann, H. R. Krikke, R. Dekker, and S. D. P. Flapper, "A characterisation of logistics networks for product recovery," *Omega*, vol. 28, no. 6, pp. 653-666, 2000.
- [4] K. Govindan, H. Soleimani, and D. Kannan, "Reverse logistics and closed-loop supply chain: A comprehensive review to explore the future," *European Journal of Operational Research*, vol. 240, no. 3, pp. 603-626, 2015.
- [5] M. W. O'Connell, S. W. Hickey, and C. Fitzpatrick, "Evaluating the sustainability potential of a white goods refurbishment program," *Sustainability science*, vol. 8, no. 4, pp. 529-541, 2013.
- [6] C. Caruso, A. Colorni, and M. Paruccini, "The regional urban solid waste management system: A modelling approach," *European Journal of Operational Research*, vol. 70, no. 1, pp. 16-30, 1993/10/08/ 1993.
- [7] L. Kroon and G. Vrijens, "Returnable containers: an example of reverse logistics," *International Journal of Physical Distribution & Logistics Management*, vol. 25, no. 2, pp. 56-68, 1995.
- [8] C.-H. Wang, J. C. Even, and S. K. Adams, "A mixed-integer linear model for optimal processing and transport of secondary materials," *Resources, Conservation and Recycling*, vol. 15, no. 1, pp. 65-78, 1995/10/01/ 1995.
- [9] T. Spengler, H. Püchert, T. Penkuhn, and O. Rentz, "Environmental integrated production and recycling management," in *Produktion und Umwelt*. Springer, 1997, pp. 239-257.
- [10] T. Penkuhn, T. Spengler, H. Püchert, and O. Rentz, "Environmental integrated production planning for the ammonia synthesis," *European Journal of Operational Research*, vol. 97, no. 2, pp. 327-336, 1997.
- [11] A. I. Barros, R. Dekker, and V. Scholten, "A two-level network for recycling sand: A case study," *European Journal of Operational Research*, vol. 110, no. 2, pp. 199-214, 1998/10/16/ 1998.
- [12] D. Louwers, B. J. Kip, E. Peters, F. Souren, and S. D. P. Flapper, "A facility location allocation model for reusing carpet materials," *Computers & Industrial Engineering*, vol. 36, no. 4, pp. 855-869, 1999.



- [13] H. Krikke, A. van Harten, and P. Schuur, "Business case Océ: reverse logistic network re-design for copiers," *OR Spectrum*, vol. 21, no. 3, pp. 381-409, 1999.
- [14] V. Jayaraman, V. Guide Jr, and R. Srivastava, "A closed-loop logistics model for remanufacturing," *Journal of the operational research society*, vol. 50, no. 5, pp. 497-508, 1999.
- [15] J. Bautista and J. Pereira, "Modeling the problem of locating collection areas for urban waste management. An application to the metropolitan area of Barcelona," *Omega*, vol. 34, no. 6, pp. 617-629, 12// 2006.
- [16] R. K. Pati, P. Vrat, and P. Kumar, "A goal programming model for paper recycling system," *Omega*, vol. 36, no. 3, pp. 405-417, 2008.
- [17] D.-H. Lee and M. Dong, "A heuristic approach to logistics network design for end-of-lease computer products recovery," *Transportation Research Part E: Logistics and Transportation Review*, vol. 44, no. 3, pp. 455-474, 2008.
- [18] R. Cruz-Rivera and J. Ertel, "Reverse logistics network design for the collection of End-of-Life Vehicles in Mexico," *European Journal of Operational Research*, vol. 196, no. 3, pp. 930-939, 8/1/ 2009.
- [19] S. S. Kara and S. Onut, "A stochastic optimization approach for paper recycling reverse logistics network design under uncertainty," *International Journal of Environmental Science & Technology*, vol. 7, no. 4, pp. 717-730, 2010.
- [20] H. Krikke, "Impact of closed-loop network configurations on carbon footprints: A case study in copiers," *Resources, conservation and recycling*, vol. 55, no. 12, pp. 1196-1205, 2011.
- [21] M. I. Gomes, A. P. Barbosa-Povoa, and A. Q. Novais, "Modelling a recovery network for WEEE: A case study in Portugal," *Waste Management*, vol. 31, no. 7, pp. 1645-1660, 7// 2011.
- [22] A. Diabat, D. Kannan, M. Kaliyan, and D. Svetinovic, "An optimization model for product returns using genetic algorithms and artificial immune system," *Resources, Conservation and Recycling*, vol. 74, pp. 156-169, 2013.
- [23] K. Schweiger and R. Sahamie, "A hybrid Tabu Search approach for the design of a paper recycling network," *Transportation Research Part E: Logistics and Transportation Review*, vol. 50, pp. 98-119, 2013.
- [24] L. F. Dai and X. F. Wang, "Research on Mixed Intelligent Arithmetic of Reuse Reverse Logistics Centers' Location Model," in *Advanced Materials Research*, 2014, vol. 945, pp. 3246-3251: Trans Tech Publ.
- [25] E. Ardjmand, G. Weckman, N. Park, P. Taherkhani, and M. Singh, "Applying genetic algorithm to a new location and routing model of hazardous materials," *International Journal of Production Research*, vol. 53, no. 3, pp. 916-928, 2015.
- [26] G. Brekelmans, R. F. Poell, and K. van Wijk, "Factors influencing continuing professional development: A Delphi study among nursing experts," *European Journal of Training and Development*, vol. 37, no. 3, pp. 313-325, 2013.
- [27] S. Keeney, F. Hasson, and H. P. McKenna, "A critical review of the Delphi technique as a research methodology for nursing," *International journal of nursing studies*, vol. 38, no. 2, pp. 195-200, 2001.



## DEVELOPMENT OF AUTOMATION IN THE DIRECTION OF HYPERAUTOMATION

Stanko P. Stankov<sup>1</sup>

<sup>1</sup>University of Niš, Faculty of Electronic Engineering, Niš, Serbia  
e-mail: [stanko.stankov@elfak.ni.ac.rs](mailto:stanko.stankov@elfak.ni.ac.rs)

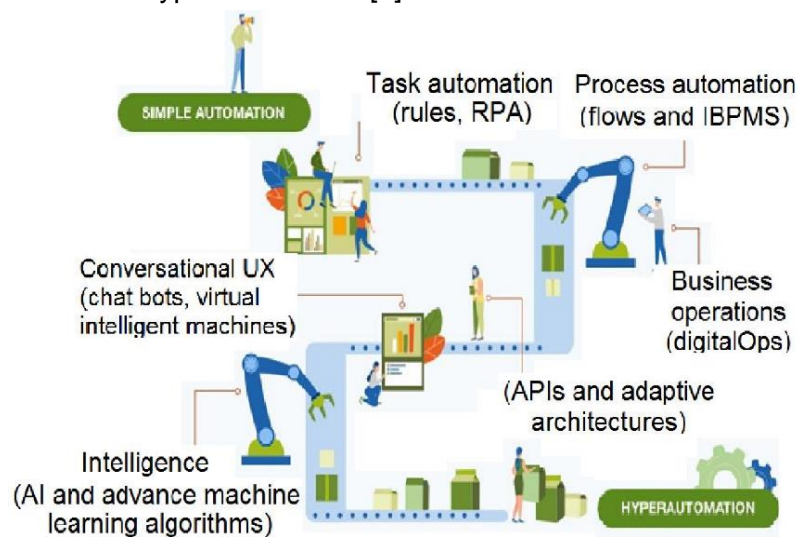
**Abstract:** Hyperautomation is an approach that companies use to quickly identify, verify and automate as many business and IT processes as possible. It includes the coordinated use of multiple technologies, tools or platforms, such as Artificial intelligence, Machine learning, Robotic process automation, Natural language processing, Integration Platform as a Service and many other solutions and tools for automating various tasks. By 2025, the hyperautomation software market is predicted to reach nearly \$860 billion due to the strong need for digital transformation and automation of industrial processes. Hyperautomation is more than process automation and it is irreversible and inevitable. Everything that can be automated will be automated. It is a revolutionary way of economic development by using multiple technologies to simplify work operations and processes while achieving maximum efficiency. Hyperautomation is the present and future of technology in the business world. It represents technology as a symphony of products and platforms working in sync to achieve a common goal. In general, hyperautomation can help industrial enterprises in several aspects: improved decision-making process, optimization of workforce engagement and potential, increase of speed and dynamics of work and the possibility of combining conventional means of automation with "low/no code" platforms (for developing and programming various applications using simplified interfaces and what is important - without actually writing code). The latter trend is gaining widespread popularity in the world of mobile applications, and more recently and in industrial robotics. Today is a time when the need for autonomy and edge computing has accelerated the adoption of cloud infrastructure in companies around the world. Cloud-based platforms should play a key role in the further development of all areas of human activity. They account for 95% of new digital initiatives in the last three years. It is observed that companies that have already adopted cloud infrastructure have completely transformed their business, operational and management models.

**Key words:** industrial automation, hyperautomation, autonomous production, robotics

### INTRODUCTION

During the 1990s, several discoveries led to significant progress. Robotic process automation (RPA) systems extracted data from images and PDF files. The experiments eventually led to the first RPA software concepts in the early 2000s. RPA has driven the acceleration of automation, including the development of artificial intelligence. It wasn't long before technology firms and researchers realized that they could combine software and tools, such as AI and Business process management (BPM). The first Intelligent Automation (IA) appeared in 2018, relying heavily on RPA tools. Hyperautomation wouldn't exist if it weren't for RPA and IA. RPA, as a forerunner of IA, contributed to the emergence of hyperautomation (according to research organization Gartner). RPA only came into mass use in 2015, but the concept has roots dating back to the 1960s. Machine learning, as a branch of artificial intelligence, became a subject of interest in the 1960s, but progressed slow for about thirty years [1]. RPA and IA have grown exponentially in a few years. The RPA industry reached \$1.58 billion in 2020 and is expected to grow by more than 30% by 2027. The evolution of RPA into IA has laid the foundation for hyperautomation (as predicted by Gartner 2019). This complex system continues to evolve, with businesses, technology firms and developers finding new ways to improve existing tools [2]. Hyperautomation is the next big and significant technological jump in the field of industrial automation. It implies the purposeful and simultaneous combining and "stacking" of innovative technological solutions

and platforms for the optimization of a given activity or task. The key elements of this concept are robotic process automation (RPA), which is based on human behavior in the execution of various protocol and repeatable tasks; artificial intelligence - AI, machine learning (ML), natural language processing (NLP), as well as platforms for intelligent data processing (IDP). A harmonious and intelligent finding of operational solutions (machines, robots, firmware, software, Supervisory Control and Data Acquisition (SCADA) systems, human-machine interfaces (HMI) and integrated computing technologies with informations (tools and hardware for data acquisition, storage and processing, networking, IoT (Internet of things) and IIoT (Industrial IoT) applications, etc.) is achieved in the production ecosystem. The growing popularity of the so-called "low/no-code" platforms for the development of software applications lies in the fact that these activities are available to practically every employee in an industrial enterprise, and not only to programmers with special qualifications. Fig. 1 shows the development road of hyperautomation [3].



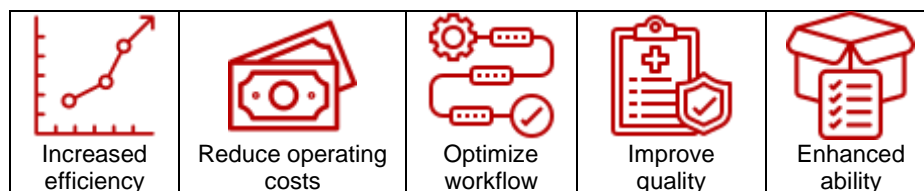
**Fig. 1.** The road to hyperautomation (source Gartner)

Technologies for optical recognition and reading of characters are also applied. In practice, they perform electronic translation of handwritten or typed documents into machine coded text. The source of information is usually a scanned document or a digital photograph of it. IDP technology is the base in the digitization process, as the first and most important stage in it, which automates the intensive conversion of data from physical (paper) media into electronic form. Hyperautomation has the flexibility to provide customizable solutions that meet the needs of a particular enterprise or industry, driving their digital transformation. The result is a holistic process of human-machine interaction to achieve maximum autonomy. The main difference between automation and hyperautomation is that the former seeks to improve the execution of individual tasks, e.g. by implementing a collaborative robot instead of a human at the workstation, while the other seeks to optimize the production process through a holistic approach. This is where the logical end goal of industrial automation is reached, i.e. fully autonomous production or production "with the lights off" - without the need for any operator intervention. It is convenient appropriate to make a semantic difference with the terms "automatic", "automated" and "autonomous". While the first two assume static, pre-programmed, strictly limited and one-dimensional human-driven activities, the third excludes the need for human participation in them. Technologies such as IIoT, AI, ML and data analytics tools provide increasing added value in modern industry by independently adjusting and optimizing technological processes "on the fly" - in real time. With the help of peripheral platforms, the computing capacity needed for this purpose "leaves" the data centers and is located on the periphery of industrial networks (edge computing), close to real machines and equipment. In just one decade, the concept of production "in the dark" or "with the lights off" due to the eliminated need for human presence has turned from a futuristic idea into a real

operational strategy, and the first truly fully autonomous factories are already a reality in the world.

## THE BENEFITS AND CHALLENGES OF HYPERAUTOMATION

Hyperautomation is transforming businesses by simplifying business processes, repetitive tasks and automating manual tasks. This has a number of key advantages. It enables organizations to complete tasks consistently, accurately and quickly. In turn, costs are reduced and the overall user experience is improved. Any new approach to business processes or infrastructure will present challenges, and hyperautomation is no exception. Many companies hesitate to tackle automation because of problems in acquisition and processing relevant data or due to a lack of resources with the technical skills to solve the problem. Retraining programs are available that can help organizations respond to these needs and develop an approach that is suitable for achieving their goals. Other challenges include choosing from an ever-evolving and growing product market. Intelligent automation uses techniques such as optical character recognition (OCR), AI and ML algorithms to mimic human actions and intelligence. A key component of hyperautomation, as mentioned, is RPA. It is a specialized software technology for automating repetitive tasks in business processes. It is applicable in various practical scenarios such as procurement, pricing, invoicing, bidding, data entry and troubleshooting in business systems. For this purpose, RPA bots are used that interact with the system or application in the same way as humans would, but much faster, more organized, more accurate and more reliable. The significant benefits that companies get by applying hyperautomation are shown in Fig. 2.



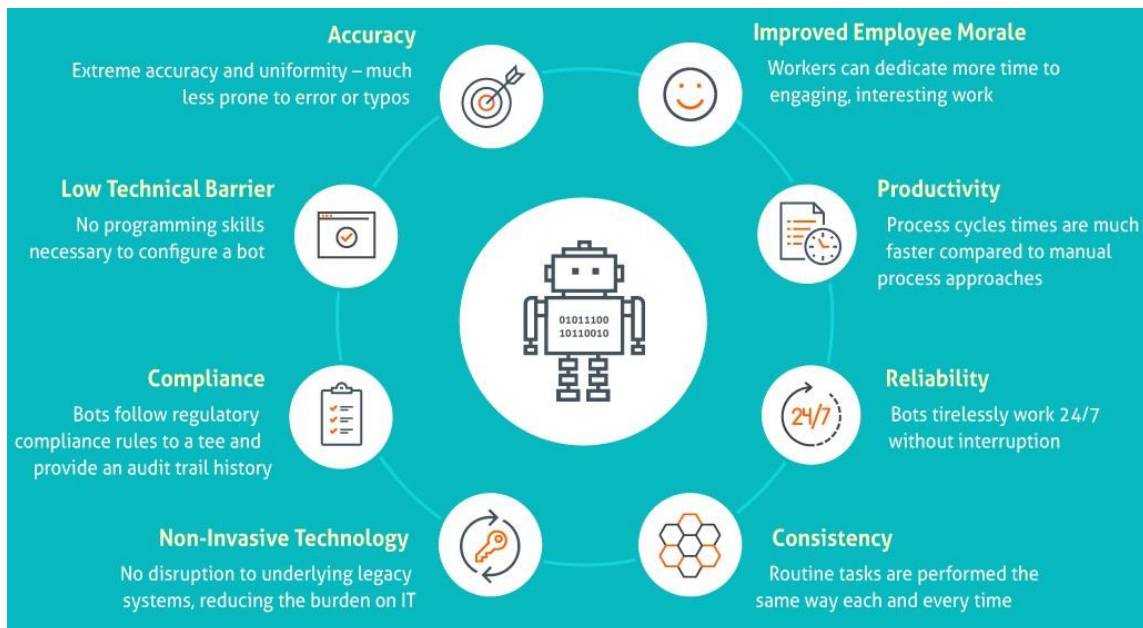
*Fig. 2. Advantages of hyperautomation*

When describing modern production processes in the context of digitization and the fourth industrial revolution, market analysts use a specific rhetoric of prefix characteristic of the transfer of large digital data. In their reports, traders constantly talk about megatrends, gigafactories, ultra-high data transfer speeds, hyperefficiency - terms that have gained wide popularity precisely because of these prefixes used in digital technology and information exchange. Along with the development of technology and equipment in production and storage, the working environment itself also developed. The concept of smart workspaces is emerging - physical places equipped with connected sensors that provide additional functionality and continuous data flow for the operation of various automated systems integrated into buildings. Smart workstations enable remote monitoring and management of various tasks, predictive maintenance and autonomous execution of tasks even in the physical absence of the operator.

## THE ROBOTIC PROCESS AUTOMATION AND ARTIFICIAL INTELLIGENCE

Hyperautomation is transforming businesses by simplifying business processes, repetitive tasks and automating manual tasks. This has a number of key advantages. It enables organizations to complete tasks consistently, accurately and quickly. In turn, costs are reduced and the overall user experience is improved. Any new approach to business processes or infrastructure will present challenges, and hyperautomation is no exception. Many companies are reluctant to tackle automation due to problems with acquiring and processing relevant data or a lack of resources with the technical skills to solve the problem.

Retraining programs are available that can help organizations respond to these needs and develop an approach that is suitable for achieving their goals. Other challenges include choosing from an ever-evolving and growing product market. Intelligent automation uses techniques such as optical character recognition (OCR), AI and machine learning algorithms to mimic human actions and intelligence. A key component of hyperautomation, as mentioned, is RPA. It is a specialized software technology for automating repetitive tasks in business processes. It is applicable in various practical scenarios such as procurement, pricing, invoicing, bidding, data entry and troubleshooting in business systems. For this purpose, RPA bots are used that interact with the system or application in the same way as humans would, but much faster, more organized, more accurate and more reliable. The advantages of RPA in hyperautomation are shown in Fig. 3.



**Fig. 3.** Robotic Process Automation in Hyperautomation function

RPA is a train that moves at breakneck speed. According to [4], the technology will reach near-universal adoption by 2025. However, just because RPA dominates the business world doesn't mean it will stop evolving. The world is in an exciting technological moment. The progress in the field of artificial intelligence in recent years is astounding. ChatGPT (an AI-powered language model developed by OpenAI, capable of generating text in a human-like manner based on context and past conversations). Other forms of generative artificial intelligence have captured the public consciousness. However, this technology is only one manifestation of the potential of AI. RPA is a simple but effective tool. However, the convergence of RPA and AI provides endless opportunities for innovation. Customer service using conversational artificial intelligence, analytics-driven decision making, and automated knowledge work are just a few examples of AI in RPA. As technology advances, cognitive robotic process automation will change the nature of work in ways we can hardly imagine. AI with RPA has already pushed the boundaries of automation before its future impact can be seen. Artificial intelligence seems to be advancing by leaps and experts are outdoing themselves year after year. Of course, progress has created a number of potential challenges for organizations seeking to implement new technologies. Some of the main problems related to artificial intelligence include issues of privacy and inherent biases in the systems. Since most companies do not develop their own AI technologies, they rely on experienced development teams. These teams need real-world data to build and test programs, which means there is a risk of leaking personal data or inaccurate training systems. Also, all AI systems have some ingrained biases in their algorithms. These



incorrect or irregular assumptions can affect the entire system and delay or prevent the achievement of optimal efficiency. RPA is intended as a simple and uncomplicated tool, at least at the user level. It is designed to be accessible to non-technical teams. In this capacity, he executes the instructions given to him in a controlled manner. Humans need to identify these processes and direct RPA to execute commands. Of course, detailed step-by-step instructions can become insufficient due to the complexity of the system - that's why combining RPA and artificial intelligence is the future of automation. The widespread use of RPA is a testament to its usefulness. Technology has helped many businesses achieve new levels of production, efficiency and accuracy by automating once manual tasks. However, like any technology, it also has an upper limit.

## **THE ROLE OF COMMUNICATION NETWORKS**

In the transition to fully autonomous factories and warehouses, the latest generations of communication networks (5G) play an essential role. They contribute to increasingly reliable mobility and connectivity of equipment. Also crucial is the importance of IoT technologies, which connect the entire range of devices – sensors, portable electronics, intelligent machines and systems into one platform in order to increase the efficiency, accuracy, productivity and profitability of business. The Internet of Things provides improved transparency of operations in smart factories, warehouses and logistics centers through centralized management and monitoring, asset tracking through the vast amount of data sent by end devices. Autonomous robots are becoming a key component of supply chains in the future and contribute to significant reductions in long-term costs, optimal utilization of workforce potential, increased productivity, improved safety, and faster order fulfillment and deliveries. as well as the automation of trivial tasks such as locating, sorting, distributing and transporting products in the warehouse. Along with autonomous robots, self-guided vehicles using radio frequencies, Light Detection and Ranging (LiDAR), scanners, bluetooth trackers, 3D machine vision cameras and smart navigation sensors are increasingly popular in digital factories and warehouses as well as portable electronic devices. (including those with augmented and virtual reality) – smart glasses, bracelets, etc. From the perspective of hyperautomation and autonomy, it is also interesting to look at the trends in industrial communication technologies that mediate this holistic approach to optimization. In order to enable the realization of truly convergent and operationally compatible networks that can simultaneously process critical and non-critical data in applications from an industrial environment, a specialized working group in the field of so-called time-sensitive networking (TSN), part of the IEEE 802.1 standardization committee, define a set of specifications for deterministic data transfer over conventional Ethernet networks. As a set of standards, the time-sensitive network concept functions more as a "toolbox" than an all-in-one solution. Users choose and combine different functions depending on the specific needs and goals of the end application. In the context of TSN technologies, it is also appropriate to mention OPC Unified Architecture (OPC UA) – an open-source IEC62541 cross-platform standard for exchanging data from sensors to cloud applications. Together, these two concepts promise to generally facilitate automation and hyper-automation processes through Industry 4.0 and IIoT solutions, making them more transparent and with greater added value than ever before.

## **ARTIFICIAL INTELLIGENCE, MACHINE LEARNING AND CYBER SECURITY**

Artificial intelligence and machine learning, which underpin hyperautomation, are rapidly changing the face of cyber security. Cyber security threats have evolved over the years, and traditional security tools are no longer sufficient to keep up with the ever-changing threat landscape. AI and ML are now being used to analyze and identify threats in real time, helping to prevent cyber attacks. One of the main advantages of AI and ML in cyber security is the ability to quickly discover and analyze large amounts of data. With the ever-increasing amount of data generated by end devices and networks, it is nearly impossible for security analysts to manually review and analyze all of this information [5]. This is where AI and ML

come in, providing a more efficient way to analyze data and identify potential threats. They also help detect unknown and new types of attacks. Traditional security tools rely on predefined patterns to detect and prevent attacks. However, with the increasing number of new and sophisticated attacks, these traditional tools are no longer effective. AI and ML can learn to recognize new and emerging patterns, even those previously unknown, and help prevent cyber attacks before they can cause significant damage. AI and ML can also be used to improve incident response. With the help of AI and ML, it is possible to create automated responses to incidents, reducing response time and minimizing the damage caused by an attack. In addition, AI and ML can be used to develop predictive analytics that help identify potential vulnerabilities and mitigate them before they are exploited. Despite the many benefits of AI and ML in cyber security, there are also some challenges. One of the main challenges is the lack of trained professionals who can develop and manage security systems based on AI and ML. Another challenge is the potential for AI and ML to be used for malicious purposes. As they continue to evolve, it is important to ensure that these technologies are used for good purposes and not create the conditions for cybercrime. In conclusion, the impact of AI and ML on cyber security is significant, and these technologies are playing an increasingly important role in protecting against cyber threats. With their ability to quickly discover and analyze large amounts of data, identify new types of attacks and improve incident response, AI and ML are helping to make the digital world safer [6]. However, as with any technology, there are challenges to overcome and it is important to ensure that these technologies are used ethically and for the greater good.

## CONCLUSION

Hyperautomation is more than automating processes. It is a revolutionary way of economic development by using multiple technologies to simplify work operations and processes while achieving maximum efficiency. Hyperautomation is the present and future of technology in the business world. It represents technology as a set of products and platforms working in sync to achieve a common goal. Every technology system has its drawbacks, including hyperautomation, which means businesses must be prepared to meet the challenges. The implementation of many automation programs is at the core of hyperautomation, which means that by definition it is a complex system. Although the technologies complement each other to make everything work, it takes time and know-how, which is not easy for several reasons. First, the organization must have a comprehensive list of all business processes, which is not always available. Building a database takes time, and then additional steps are needed to determine which processes should be considered first. If there is a misunderstanding between the teams about the process or where to start, it can delay the start of implementation. Hyperautomation uses multiple products, platforms, and tools to create a balanced and efficient system for automating all possible tasks. It focuses on the process and creating a single system that works to sustain the business, which means a multi-stage implementation. A digital twin approach was developed to help companies define hyperautomation parameters. In principle, the company creates a virtual model of existing organizational processes and the way they currently function. Using information and task retrieval tools, it is possible to manipulate the virtual construction for identification purposes and experiment with different applications to see how the automation will perform in real-world conditions. The business can also identify potential problems or opportunities for further automation at each stage.

## REFERENCES

- [1] The Gartner 2023 Predictions: Hyperautomation (Inclusive of AI, RPA & Low Code)  
<https://www.gartner.com/en/webinar/448856/1058287>
- [2] <https://www.zaptest.com/hyperautomation>
- [3] <https://nividous.com/blogs/what-is-hyperautomation>
- [4] <https://www.deloitte.com/global/en.html>



- [5] Stankov, S., Big Data in Water Supply and Sewerage System, journal Acta Technica Corvinensis – Bulletin of Engineering, Tome XV, Fascicule 1 [January – March], pp. 21 - 25, Publisher: University Politehnica Timisoara, Faculty of engineering Huenedoara, Romania, 2022.
- [6] <https://www.kaspersky.com/resource-center/definitions/ai-cybersecurity>



## TRUST IN CONSTRUCTION PROJECTS

Ali Reza Afshari<sup>1</sup>, Diana Dast Pak<sup>2</sup>

<sup>1</sup>Department of Construction Management, Mashhad Branch,  
Islamic Azad University, Mashhad, Iran.  
E-mail: [afshari@mshdiau.ac.ir](mailto:afshari@mshdiau.ac.ir)

**Abstract:** Construction projects based on collaboration among contracting parties to accomplish project goals. While tremendous focus placed in management research on new technologies, the social and human factors through which these studies implemented in an organization seldom neglected. Thus, it is crucial to quickly build teams and establish good communications between team members. Trust has been determined by many studies as an excellent determinant to successful projects and crucial to build integrated project teams. The aim of this paper is to present a literature review of research on trust in construction, identify knowledge gaps, and suggest recommendations for future research.

**Key words:** trust, construction industry, project success, project cost management, project delivery methods, construction projects.

### INTRODUCTION

Trust is one of the metrics used to identify the nature of inter-organizational interactions in construction projects [1]. Trust strongly affects the strength of inter-organizational relationships and, ultimately, project success [2]. Trust determines the relationship between team members, which the project flow relies on. Trust affects the interactions between individuals within the project and each individual's performance. In construction projects, trust is an essential foundation for successful collaboration among team members. Trust enables team members to rely on each other's expertise, knowledge, and skills and to work effectively together towards a common goal. When team members trust each other and feel comfortable expressing their concerns and ideas, it can create a more positive and collaborative atmosphere. Without trust, team members may be hesitant to share information or express their concerns, leading to misunderstandings and conflicts. This situation can result in delays, increased costs, and a lack of project cohesion. On the contrary, when trust is present, team members are more likely to collaborate and share their knowledge and expertise, leading to more innovative and efficient solutions. Furthermore, trust fosters a positive work environment, increasing morale and productivity. In other words, creating trust in construction projects requires open communication, collaboration, honesty, reliability, and professionalism from all team members. Therefore, it is essential to overcome distrust in construction projects [3].

Trust has highlighted in both the Latham [4] and Egan [5] reports as a major factor leading to the success or failure of construction projects. Trust proposed by many studies as an aspect that improves the success rate of projects and, thus, should be included within the discipline of project management [6]. With construction projects that mainly aim at achieving a common set of goals through the collaboration of the project participants, it becomes critical for all teams involved to build teams and establish good communications [7, 8]. While tremendous focus placed in management research on new technologies, the social and human factors through that these studies implemented in an organization seldom neglected. As per the Rethinking Project Management Network, more emphasis must place on comprehending the less tangible management aspects of the construction project, such as building trust, organization learning, and building of an organizational culture able to operate with high uncertainty levels. An increasing trend in the construction management research noticed on the less tangible management aspects, including trust in construction. Therefore, it becomes important to study how these teams built, how trust is developed, and how trust between team members affects

the project's outcomes [9]. The aim of this paper is to present a comprehensive review of research literature on trust in construction and identify gaps of knowledge where future research in "trust" should be conducted.

### **Trust in the Construction Industry**

Trust has been recognized and reported as a crucial element contributing to the success or failure of construction projects [2]. Trust is widely recognized as a "psychological state which comprises the intention to accept vulnerability based upon positive expectations of the intentions or behavior of another". Three primary criteria that emerge as necessary are honest communication, reliance, and the delivery of results. When there are clear communications in a construction project, individuals effectively convey their expectations of one another. On the contrary, unfulfilled individual expectations result in distrust. Trust created during certain situations or several projects. It may break down, certain factors can erode trust, and re-establishing it is not always simple. Only trust can positively affect the transaction when fear and skepticism are reduced via distrust-related contract rules. Contract research has focused substantially on trust but disregarded the beneficial effect of addressing distrust in enhancing project efficiency [10]. Distrust originates from an incongruous viewpoint between an organization's values and those of its partner, which causes suspicion that a partner could behave opportunistically. Conceptualizing trust and distrust as two independent categories gives insights into how organizations encourage trust, as good intentions may be expected without considerable monitoring [3]. The majority of individuals trust the old system, with its inherent faults, and may even be deeply invested in mitigating them. The same or a greater level of trust must be demonstrated and maintained in any new system. The balance of certain degrees of trust and distrust during the initial stages of cooperation could benefit the later collaboration stage [11]. Research on soft factors such as trust in construction projects is limited. Trust is a human behavior that affects construction projects, and having more trust would help to overcome the implementation challenges. Trust in construction projects is essential for effective communication and collaboration, improving project quality, increasing efficiency and productivity, and achieving project success.

Although trust has been discussed in many disciplines for several decades, it was not before the 1980s that it started to gain interest in management [9, 12]. The way relationships are established and sustained by trust has been widely studied in the fields of social sciences, anthropology, economics, psychology, and sociology. The purpose of this section is to introduce the different lines of research that have been studied in trust in construction for the past 25 years. It would be appropriate though to start by defining what trust means. Trust is a psychological state involving vulnerability, where a belief exists that the individual/organization on whom we depend will meet our positive expectations rather than our fears [13-15]. Although trust and cooperation are directly related [16], trust is not equivalent to cooperation as a party can meet our expectation induced by coercion rather than trust. It is important to note that individuals can only grant trust, not organizations. Thus, when the term "inter-organizational trust" is used, it means that individuals within the organizations trust the organization to which the other individual is a member [17].

Wong et al. [18] categorized trust into system-based, cognition-based, and affect-based. On the same lines, a color of trust model that specifies three primary colors/types was also proposed by Zaghoul [19]. These primary trust colors can be mixed to form the secondary colors that define trust requirements for different relationships and situations [19]. Others categorized them based on the trust source, such as deterrence-based, knowledge-based, and identification-based trust; or simple trust, basic trust, and authentic trust [20]. In addition, trust was also investigated, based on the relationship between the parties involved; parties of equal or unequal power, trust based on belonging to specific groups, or based on past parties' relationship [9]. Other trust types identified, depending on their source whether calculus-based, relational-based, and institution-based trust [12, 20]. Another line of research observed significantly in trust is identifying factors that develop or deter trust. A study by Lendra and

Andi's [21] aimed to measure the levels of trust in a subcontracting relationship through the considering of internal and external factors. Results showed the trust level in subcontracting relationships is high, with internal factors being more significant than the external factors [21]. Social interaction and attitude on work also identified in another study as significant factors affecting interpersonal trust [22]. On these same lines, Wong et al. [18] aimed at conceptualizing trust through defining trust types in terms of behaviors that affect trust development. The study concluded that in construction, clients acquire most information from records, i.e., cognitive-based trust having highest influence on trust-building [18], which were in agreement with McAllister [13] study. Structural Equation Modeling (SEM) used to prove the positive relationship of partners' trust level to their performance, permeability, and relational bonding [23].

Other studies aimed at measuring trust levels between project participants such as the Engineering and Physical Sciences Research Council study that developed a trust inventory for assessing trust levels in project teams. The study used Social Network Analysis tool to identify key project relationships [7, 8]. Results showed trust developed through communication, reliance, and reputation [7]. Cheung et al. [24] also developed a trust inventory to evaluate the level of the different trust types in projects. Romahn and Hartman [9] stressed the importance of having project managers understand trust and its impact on project success. Based on work conducted in different disciplines, they proposed a two-part trust model that addresses the reasons leading to trust building between individuals, groups, and organizations [9].

Other researchers investigated the different perspectives of the parties involved of both building and breaching trust and stated [25]. Macroeconomics effect also investigated as a factor that might affect trust [26]. On the other side, Jing and Ling [15] developed a framework for fostering trust and building relationships through identifying the risks and the respective trust-fostering tools in each project developmental stage. Therefore, with more risks, more trust is needed [15]. Chow et al. [27] aimed at investigating trust-building mechanisms in terms of how the trusting behaviors can reciprocated. Networking and calculative-ness (containing undesired conduct) found to relate to trust expectations. Wong et al. [23] adopted "the prisoner's dilemma" framework which suggests the trust cycle can start by having parties consider cooperation as their priority compared to competition and self-interest, concluding that the contractor could be the initiator of trust.

### **Construction Project Success and Trust**

Trust also studied in terms of its effect on project success through developing high performance teams and improved efficiency. The relationship between trust and human perceptions of inter-organizational teamwork also investigated in a study by Fong and Lung [28]. Webber [29] examined the effect of teaming with the client through blended service on achieving better client relationship, and thus better project performance. The study showed that client's trust lead to better team trust, team cohesion, and team performance which was in conformance with Karlsen et al. [30] study conclusions. Pinto et al. [1] also investigated the impact of trust between project owners and contractors, proving trust importance in better project performance. Trust, among other factors, also identified as a key indicator for supply chain relationships in construction and tested for its impact on project performance. The study concluded that the supply chain collaboration and collaborating is key in solving performance problems [31]. Cheung et al. [32] developed a model that demonstrated how trust affects communication that accordingly influences project performance.

### **Construction Contracts and Trust**

Although contracts viewed as a legal document whose main objective is to avoid risk, others see it as a basis for mutual trust between parties [20]. Studies in contracts aimed at exploring the benefits of having less detailed contracts [14]. Lau's study questioned whether the details in the contracts could decreased to provide room for flexibility in contract execution. Their study

results showed that although respondents agree that working with a contract with little details is a strong form of trust, they would not feel comfortable working with such a contract [14]. Along these same lines, Kadefors [12] study on the factors that influence development of trust and cooperation concluded that the client-contractor relationship, based on the current contract and procurement system, produces an uncooperative relationship. On same lines, Cheung et al. [33] generated a relational index with trust being one of its factors to test relational construction contracts by comparing different contract types. Trust also seen as a very strong aspect in resolving construction disputes. It was included in a model developed to predict mediating outcomes based on tactics employed. Trust-building tactics used by mediators further developed and tested for efficacy based on the mediation outcomes reached, proving to be a great time saving tool [34]. Gad and Shane [35, 36] also investigated the effect trust level have on the selection of dispute resolution method in the contract document. It seen from the study that though experts recommend that trust should be taken in consideration in selecting dispute resolution methods, industry professionals in drafting contract documents do not consider it.

### **Construction Project Cost Management and Trust**

Not only does trust reflected in the contract clauses affect the relationship between the involved parties, it also has a significant effect on increase of the total cost of a project [37]. With trust comes costs that are either direct costs for building it, costs that may arise out of trust breach, or costs of inefficiency due to excessive trust [12]. A study conducted in 1993 by the Construction Industry Institute analyzed the relationship between cost and trust. Ten years later, Zaghoul [37] conducted a study to determine the premium amount placed on the disclaimer contract clauses that attempt to transfer risk from one party to the other. From administering 300 surveys to construction professionals, it was reported that the premium percentage in construction ranged from 8% to 20%, which are usually based on the party's business relationship with the owner, project conditions, type of contract, and fairness. Results show that disclaimer clauses always lead to a loss to at least one party, whether risk evolves to become a problem or not. Consequently, there are opportunities of better risk allocation if a trust relationship built between the parties. Trust should govern how people deal with project risks, since these risks will vary, depending on the parties' relationship. In general, trust level in construction industry is low.

### **Construction Project Delivery Methods and Trust**

It is not surprising to see that most research in construction has affiliated trust with collaborating as it known to decrease the adversarial environment, increase cooperation, and reduce inefficiencies in construction projects. Many research studies examined how partnering arrangements are implemented to foster building trust [18, 38, 39] while other researchers determined trust as a factor that facilitates relational contracting [40], alliancing [41], strategic alliancing success [42], and international joint ventures [43]. It found that trust is the most important factor in building it; a culture revolution needed to break down barriers against trust building [40]. Studies in project alliance prove it to a good start for initiating the trusting relationship as it provides better alignment of incentives and risks sharing compared to traditional or design-build contracts [41]. A multi-cultural study including data on relational contracting from five different countries was also conducted [44]. In general, trust and trust-based operational arrangements were proven to offer the required stage for implementing relational based arrangements [45, 46]. Lazar [47] used game theory to provide better understanding of the partnering relationships and the need to maintain a consistent cooperative relationship to develop and maintain trust. Trust and respect added among other factors to the formula developed to calculate the key performance indicator for successful relational projects [48]. Trust also studied by investigating its perceived meaning and behaviors that foster trust in ethical partnering practices [7]. Some studies compared the factors that attribute to the success of relational versus traditional projects [49, 50]. Trust, cost efficiency,

and communication are key drivers for successful projects in both types of projects. However, traditional contracting seen to lead to many inefficiencies due to the contractual arrangements that define different processes [50]. This also emphasized by Soares [51] stating that the current construction organizations hinder building trust due to the segregated nature of the work process.

## RESULTS AND DISCUSSION

Through the literature review conducted, six lines of research identified; trust types, factors affecting trust development, trust and project success, contracts, costs, and project delivery methods. Some significant observations made through the identification.

- It seen that most research in the area of trust in construction is geared towards the first three lines of research, in addition to relational contracting.
- Although project cost is a pivotal aspect in construction projects, only two studies found that attempted to quantify the effect of trust on reducing project costs. With many authors suggesting having less adversarial and less detailed contracts,
- There is yet limited research conducted in the areas of contracts and trust. As pertains to project delivery methods, it becomes obvious that trust mostly addressed in relational agreements such as collaborating and alliancing.
- There exist a gap of knowledge in areas of non-relational project delivery methods, costs, risk, and contracts, as related to trust.

## CONCLUSION

The aim of this paper is to identify the lines of research conducted in the area of trust in construction and identify the knowledge gaps. Through a literature review conducted on more than 50 peer-reviewed publications, it seen that trust aspects in construction are gaining greater research attention as they are implicitly starting to change our contractual environment through less adversarial relationships. Researchers increasingly seen to address trust in a more systematic manner, just as in other disciplines, in attempt to develop models that be used to identify trust types, develop trust, measure, and maintain it in a construction project. Although it observed that the trend of construction trust research is increasing, there still exists a crucial need to introduce trust into our project management operations. The following recommendations for future research thus suggested:

- 1) Develop measures to quantify and relate trust to project cost,
- 2) Determine the relationship between risk and trust in construction projects,
- 3) Determine how construction contracts can be drafted to best reflect the trust perception between the contracting parties, and
- 4) Compare trust levels in different project delivery methods (such as design-build, construction manager at risk and public-private-partnerships), whether from team's perception or the contractual agreement perspective.

## REFERENCES

- [1] J. K. Pinto, D. P. Slevin, and B. English, "Trust in projects: An empirical assessment of owner/contractor relationships," *International Journal of project management*, vol. 27, no. 6, pp. 638-648, 2009.
- [2] A. M. Farouk, A. Z. Zulhisham, Y. S. Lee, M. S. Rajabi, and R. A. Rahman, "Factors, challenges and strategies of trust in BIM-Based construction projects: A case study in Malaysia," *Infrastructures*, vol. 8, no. 1, p. 13, 2023.
- [3] C.-Y. Lee, H.-Y. Chong, B. L. Tanko, and M. Klufallah, "Effect between trust in communication technology and interorganizational trust in BIM-enabled projects,"

- Journal of Construction Engineering and Management*, vol. 148, no. 8, p. 04022059, 2022.
- [4] S. M. Latham, "Constructing the team," 1994.
- [5] T. Department of the Environment, t. R. C. T. Force, and J. Egan, *Rethinking construction*. DETR, 1998.
- [6] M. Ghada and J. S. SHANE, "Dispute Resolution Methods' Choice in International Contracts: A Survey of International Contractors' Perspective of Trust."
- [7] W. Swan, P. McDermott, G. Wood, A. Thomas, and C. Abott, *Trust in construction: achieving cultural change*. Centre for Construction Innovation Manchester, 2002.
- [8] H. Smyth *et al.*, "ournal of Construction Procurement," *Journal of Construction Procurement*, vol. 50, no. 1, p. 1, 2005.
- [9] E. Romahn and F. Hartman, "Trust: A new tool for project managers," in *Proceedings of the 30th Annual Project Management Institute 1999 Seminars and Symposium*, 1999, vol. 10, p. 16.
- [10] C. Y. Lee, H.-Y. Chong, and X. Wang, "Enhancing BIM performance in EPC projects through integrative trust-based functional contracting model," *Journal of Construction Engineering and Management*, vol. 144, no. 7, p. 06018002, 2018.
- [11] H. Xiao, T. Broyd, and M. Cidik, "Towards a theoretical framework of trust in BIM-enabled collaboration," 2022: EC3.
- [12] A. Kadefors, "Trust in project relationships—inside the black box," *International Journal of project management*, vol. 22, no. 3, pp. 175-182, 2004.
- [13] D. J. McAllister, "Affect-and cognition-based trust as foundations for interpersonal cooperation in organizations," *Academy of management journal*, vol. 38, no. 1, pp. 24-59, 1995.
- [14] E. Lau, "Trust in contract and its cultural perspective," in *Cutting Edge and ROOTS conference*, 2001.
- [15] X. H. Jin and F. Y. Y. Ling, "Constructing a framework for building relationships and trust in project organizations: two case studies of building projects in China," *Construction Management and Economics*, vol. 23, no. 7, pp. 685-696, 2005.
- [16] K. Bijlsma and P. Koopman, "Introduction: trust within organisations," *Personnel Review*, vol. 32, no. 5, pp. 543-555, 2003.
- [17] K. J. Blois, "Trust in business to business relationships: An evaluation of its status," *Journal of management studies*, vol. 36, no. 2, pp. 197-215, 1999.
- [18] W. K. Wong, S. O. Cheung, T. W. Yiu, and H. Y. Pang, "A framework for trust in construction contracting," *International journal of project management*, vol. 26, no. 8, pp. 821-829, 2008.
- [19] R. Zaghoul and F. T. Hartman, "Reducing contract cost: The trust issue," *AACE International Transactions*, p. CD161, 2002.
- [20] D. M. Rousseau, S. B. Sitkin, R. S. Burt, and C. Camerer, "Not so different after all: A cross-discipline view of trust," *Academy of management review*, vol. 23, no. 3, pp. 393-404, 1998.
- [21] L. Lendra, "Tingkat kepercayaan dalam hubungan kemitraan antara kontraktor dan subkontraktor di surabaya," *Civil Engineering Dimension*, vol. 8, no. 2, pp. 55-62, 2006.
- [22] Z. Ding and F. Ng, "Personal construct-based factors affecting interpersonal trust in a project design team," *Journal of Construction Engineering and Management*, vol. 136, no. 2, pp. 227-234, 2010.
- [23] P. S. P. Wong and S. O. Cheung, "Structural equation model of trust and partnering success," *Journal of Management in Engineering*, vol. 21, no. 2, pp. 70-80, 2005.
- [24] S. O. Cheung, W. K. Wong, T. W. Yiu, and H. Y. Pang, "Developing a trust inventory for construction contracting," *International Journal of project management*, vol. 29, no. 2, pp. 184-196, 2011.
- [25] M. M. Khalfan, P. McDermott, and W. Swan, "Building trust in construction projects," *Supply chain management: an international journal*, vol. 12, no. 6, pp. 385-391, 2007.



- [26] E. Manu, N. A. Ankrah, E. Chinyio, and D. G. Proverbs, "Influence of the macroeconomy on trust in construction supply chain chains," in *Procs. 28th Annual ARCOM Conference*, 2012, pp. 665-674: Citeseer.
- [27] P. T. Chow, S. O. Cheung, and K. Y. Chan, "Trust-building in construction contracting: Mechanism and expectation," *International Journal of Project Management*, vol. 30, no. 8, pp. 927-937, 2012.
- [28] P. S. Fong and B. W. Lung, "Interorganizational teamwork in the construction industry," *Journal of construction engineering and management*, vol. 133, no. 2, pp. 157-168, 2007.
- [29] S. S. Webber, "Blending service provider-client project teams to achieve client trust: Implications for project team trust, cohesion, and performance," *Project Management Journal*, vol. 39, no. 2, pp. 72-81, 2008.
- [30] J. T. Karlsen, K. Graee, and M. J. Massaoud, "The role of trust in project-stakeholder relationships: a study of a construction project," *International Journal of Project Organisation and Management*, vol. 1, no. 1, pp. 105-118, 2008.
- [31] X. Meng, "The effect of relationship management on project performance in construction," *International journal of project management*, vol. 30, no. 2, pp. 188-198, 2012.
- [32] S. O. Cheung, T. W. Yiu, and M. C. Lam, "Interweaving trust and communication with project performance," *Journal of construction engineering and management*, vol. 139, no. 8, pp. 941-950, 2013.
- [33] S. O. Cheung, K. T. Yiu, and P. S. Chim, "How relational are construction contracts?," *Journal of professional issues in engineering education and practice*, vol. 132, no. 1, pp. 48-56, 2006.
- [34] T. W. Yiu and W. Y. Lai, "Efficacy of trust-building tactics in construction mediation," *Journal of Construction Engineering and Management*, vol. 135, no. 8, pp. 683-689, 2009.
- [35] G. M. Gad and J. S. Shane, "A Delphi study on the effects of culture on the choice of dispute resolution methods in international construction contracts," in *Construction Research Congress 2012: Construction Challenges in a Flat World*, 2012, pp. 1-10.
- [36] G. M. Gad and J. S. Shane, "Trust in the construction industry: A literature review," in *Construction research congress 2014: Construction in a global network*, 2014, pp. 2136-2145.
- [37] R. Zaghoul and F. Hartman, "Construction contracts: the cost of mistrust," *International journal of project management*, vol. 21, no. 6, pp. 419-424, 2003.
- [38] S.-O. Cheung, T. S. Ng, S.-P. Wong, and H. C. Suen, "Behavioral aspects in construction partnering," *International journal of project management*, vol. 21, no. 5, pp. 333-343, 2003.
- [39] A. P. Chan, D. W. Chan, Y. H. Chiang, B.-S. Tang, E. H. Chan, and K. S. Ho, "Exploring critical success factors for partnering in construction projects," *Journal of construction engineering and management*, vol. 130, no. 2, pp. 188-198, 2004.
- [40] M. M. Kumaraswamy, M. M. Rahman, F. Y. Ling, and S. T. Phng, "Reconstructing cultures for relational contracting," *Journal of construction engineering and management*, vol. 131, no. 10, pp. 1065-1075, 2005.
- [41] A. Laan, N. Noorderhaven, H. Voordijk, and G. Dewulf, "Building trust in construction partnering projects: An exploratory case-study," *Journal of purchasing and supply management*, vol. 17, no. 2, pp. 98-108, 2011.
- [42] T. Xu, N. Smith, and D. Bower, "Forms of collaboration and project delivery in Chinese construction markets: Probable emergence of strategic alliances and design/build," *Journal of Management in Engineering*, vol. 21, no. 3, pp. 100-109, 2005.
- [43] G. Girmscheid and C. Brockmann, "Inter-and intraorganizational trust in international construction joint ventures," *Journal of construction engineering and management*, vol. 136, no. 3, pp. 353-360, 2010.

- [44] M. M. Rahman and M. M. Kumaraswamy, "Multicountry perspectives of relational contracting and integrated project teams," *Journal of Construction Engineering and Management*, vol. 138, no. 4, pp. 469-480, 2012.
- [45] M. M. Rahman and M. M. Kumaraswamy, "Relational selection for collaborative working arrangements," *Journal of Construction Engineering and Management*, vol. 131, no. 10, pp. 1087-1098, 2005.
- [46] M. M. Rahman and M. M. Kumaraswamy, "Relational contracting and teambuilding: Assessing potential contractual and noncontractual incentives," *Journal of Management in Engineering*, vol. 24, no. 1, pp. 48-63, 2008.
- [47] F. D. Lazar, "Project partnering: improving the likelihood of win/win outcomes," *Journal of management in engineering*, vol. 16, no. 2, pp. 71-83, 2000.
- [48] J. F. Yeung, A. P. Chan, and D. W. Chan, "Developing a performance index for relationship-based construction projects in Australia: Delphi study," *Journal of management in engineering*, vol. 25, no. 2, pp. 59-68, 2009.
- [49] E. Lau and S. Rowlinson, "Interpersonal trust and inter-firm trust in construction projects," *Construction management and economics*, vol. 27, no. 6, pp. 539-554, 2009.
- [50] H. Doloi, "Empirical analysis of traditional contracting and relationship agreements for procuring partners in construction projects," *Journal of Management in Engineering*, vol. 29, no. 3, pp. 224-235, 2013.
- [51] R. Soares, "Trust-the missing link in construction," *International Journal of Business and Social Science*, vol. 3, no. 23, 2012.



## NATURAL ENVIRONMENT PROTECTION AS A STAKEHOLDER IN SERBIAN HEALTHCARE SYSTEM

Tanja Milić<sup>1</sup>, Dragica Milić<sup>2</sup>

<sup>1</sup>University of Belgrade, Faculty of Organizational Sciences, Belgrade, Serbia

e-mail: [tanja.milic@fon.bg.ac.rs](mailto:tanja.milic@fon.bg.ac.rs)

<sup>2</sup>Clinical Center of Serbia, Clinic for Neurology

**Abstract:** Modern stakeholder management theory approvals recognize the natural environment as a corporate stakeholder. However, scientific research in the domain of its protection is particularly scarce, especially in the field of healthcare. This empirical research paper investigates the level of natural environment protection as a stakeholder in the Serbian healthcare sector. A total of 101 managers of healthcare organizations operating in the territory of the Republic of Serbia were tested using quantitative research techniques via the Internet (Computer Assisted Web Interview - CAWI) with previous consent from each subject for participation in the study. Results show that pharmaceutical organizations place the greatest focus on protecting the natural environment as a stakeholder, followed by secondary and tertiary healthcare organizations, ending with primary healthcare organizations.

**Key words:** natural environment protection as a stakeholder, healthcare system, Republic of Serbia

### INTRODUCTION

Since Freeman's [10] popularization of the definition of stakeholders as ". . . any group or individual who can affect or is affected by the achievement of the organization's objectives", various proposals of who the stakeholder can be have risen. Modern stakeholder management theory approvals recognize the natural environment as a corporate stakeholder [4, 2, 11]. Moreover, over the past two decades many large corporations have begun to acknowledge that they must hold themselves responsible and take measures to reduce the environmental degradation, pollution, climate change, and social disruption that results from their activities [20, 23]. In response to this, more and more companies are moving towards a strategic approach designed to integrate environmental considerations into their strategies [25, 12], leading to the marked rise of the natural environment in its strategic importance [1]. In the last decade, there has also been increased interest in healthcare organizations' environmental impacts [24, 16]. Many authors have pointed up negative environmental impacts caused by healthcare [9, 21]. The healthcare sector constitutes a major part of the economy of developed nations and consumes significant quantities of consumables [15]. So far research shows that, for example, the US healthcare delivery industry alone consumes vast resources, the majority of which become waste - nearly 7000 tons of hospital waste is created daily [23]. The healthcare delivery sector is responsible for 10% of all greenhouse gas emissions, 12% of acid rain, 10% of smog formation, and 9% of criteria air pollutants (ground-level ozone, particulate matter, carbon monoxide, lead, sulfur dioxide, and nitrogen dioxide), which leads to indirect health burdens commensurate with the 44 000 to 98 000 hospital deaths each year from preventable medical errors [8]. Also, on basis of data collected, it has been established that with a population of just over seven million, Serbia generates between 4,500 and 5,000 tons of infectious waste on an annual basis of which some 20% originates from the treatment of out-patients, 75% from the treatment of in-patients and 5% from micro-biological laboratory tests [14]. It is also estimated that approximately 48,000 tons of total waste is produced in all healthcare institutions in Serbia every year, about 9,600 tons of which could be considered hazardous [13].

In this situation, it is highly important to estimate the awareness among population regarding healthcare environmental issues. Nevertheless, research on environmental issues in healthcare sector is still limited and does not provide comprehensive insight into this issue. In that sense, as a starting point, this empirical research paper investigates the level of natural environment protection as a stakeholder in the Serbian healthcare sector.

## **MATERIAL AND METHODS**

In order to identify the level of natural environment protection as a stakeholder within healthcare sector in the Republic of Serbia, an empirical study was conducted. The research was based on the application of data collection methods from primary sources. The research was organized respecting principles of the methodology of scientific research by Mihailović [17].

### **Research Purpose and Research Questions**

The purpose of the research is to examine perceptions and attitudes of managers of healthcare organizations operating in the Republic of Serbia in relation to the natural environment protection as a stakeholder and to use surveyed perceptions and attitudes of managers to evaluate the degree of significance of the natural environment protection as a stakeholder in healthcare sector of the Republic of Serbia. Considering that healthcare sector includes several subsectors, in the following part, the purpose of managerial opinion research is aimed at examining the differences in the perception of the natural environment protection as a stakeholder between certain healthcare subsectors, such as pharmaceutical, primary healthcare, and secondary and tertiary healthcare. In this way, it is possible to find out for which healthcare subsector the natural environment protection as a stakeholder is of the greatest importance.

In order to fulfill the purpose of the research, following research subjects are defined: (1) measuring attitudes of managers of healthcare organizations operating in the Republic of Serbia about the natural environment protection as a stakeholder; (2) identifying and measuring the differences in the perception of the natural environment protection as a stakeholder between certain healthcare subsectors.

The research had following defined goals: (1) determining the degree of significance of the natural environment protection as a stakeholder for managers of healthcare organizations operating in the Republic of Serbia; (2) determining the existence of statistically significant differences between healthcare subsector and the degree of significance of the natural environment protection as a stakeholder for managers of healthcare organizations operating in the Republic of Serbia.

The research is expected to lead to answers to following research questions: (1) to what extent the natural environment protection as a stakeholder has an impact on healthcare business decision making and healthcare business life in the Republic of Serbia; (2) whether there is and what, if any, statistically significant difference, the connection, between the healthcare subsector and respondents' attitudes regarding the natural environment protection as a stakeholder of healthcare organizations operating in the Republic of Serbia.

### **Research Participants**

Participants in the study were managers of healthcare organizations operating in the territory of the Republic of Serbia. The survey was conducted on a sample of 101 respondents. Testing managers of healthcare organizations has been conducted using quantitative research techniques via the Internet (Computer Assisted Web Interview - CAWI) with previous consent from each subject for participation in the study. As a sample frame, publicly available databases of healthcare organizations in Serbia are used.

## Research Instrument

As a research tool for implementation of the method of collecting data from primary sources, the 7-point Likert scale questionnaire was used, established on the basis of review of the scientific and expert literature and as recommended by Mihailović [17], Saunders, Lewis and Thornhill [22], Babbie and Mouton [3], Welman, Kruger and Mitchell [27], Boyce [5], and Dillman [7], and in compliance with special needs of research. After data about the organization, the questionnaire contained question pertaining to the natural environment protection as a stakeholder. Results of Cronbach's alpha test of questionnaire as a measure of its reliability indicate the consistent reliability of results obtained ( $\alpha > 0.7$ ) [6].

## Research Model

The research model is based on examining perceptions and attitudes of managers of healthcare organizations operating in the Republic of Serbia in relation to the natural environment protection as a stakeholder. In the second step, the research model refers to the examination of the differences in the perception of the natural environment protection as a stakeholder between specific respondents' healthcare industry field.

## Data Analysis

Data analysis in this study consisted of descriptive statistics. Univariate analysis containing individual ranking statistics was used. The non parametric Kruskal-Wallis test, and post hoc Mann Whitney U test were used to test the significance of differences. In the study, results with  $p < 0.05$  were declared significant.

## RESULTS AND DISCUSSION

### Evaluation of the importance of the natural environment protection as a stakeholder for healthcare managers in the Republic of Serbia

In order to evaluate the importance of the natural environment protection as a stakeholder for healthcare managers in the Republic of Serbia, univariate analysis containing individual ranking statistics was used. Results are shown in Table 1.

**Table 1.** Statistical summary of univariate analysis of the importance of the natural environment protection as a stakeholder for healthcare managers in the Republic of Serbia

The parameter	Mean ( $\mu$ )	Std. Dev.
Our organization focuses on protecting the natural environment as a stakeholder	4.58	1.93

Research findings reveal that most managers of healthcare organizations operating in the Republic of Serbia recognize the crucial role that the natural environment protection as a stakeholder plays for the success and sustainability of their operations, since it carries mean that is above average ( $\mu > 4.00$ ).

### Evaluation of the differences in the managers' perception of the natural environment protection as a stakeholder between certain healthcare subsectors

In order to determine the level of the natural environment protection as a stakeholder per healthcare subsectors in the Republic of Serbia, the investigation of the differences in the managers' perception of the natural environment protection as a stakeholder between certain healthcare subsectors, such as pharmaceutical, primary healthcare, and secondary and tertiary healthcare, is performed. The nonparametric Kruskal-Wallis and post hoc Mann

Whitney U test were used to examine the significance of differences. Results with  $p < 0.05$  were declared significant (Table 2.).

**Table 2.** Healthcare subsector differences in the natural environment protection as a stakeholder

The parameter	Healthcare subsector rank			p
	Pharmaceutical organization (x <sub>1</sub> )	Primary healthcare organization (x <sub>2</sub> )	Secondary and tertiary healthcare organization (x <sub>3</sub> )	
Our organization focuses on protecting the natural environment as a stakeholder	1040	776	812	$p < 0.05$

In relation to the importance of the natural environment protection as a stakeholder for managers of healthcare organizations operating in the Republic of Serbia, it was examined whether there are statistically significant differences between respondents coming from three healthcare subsectors: pharmaceutical, primary healthcare, and secondary and tertiary healthcare. According to research results, respondents from pharmaceutical organizations give more importance to the focus on protecting the natural environment as a stakeholder, than respondents from primary healthcare, and secondary and tertiary healthcare organizations (1040 vs. 776 vs. 812;  $p < 0.05$ , Kruskal-Wallis test). Also, from the same data can be seen that primary healthcare organizations devote the least importance to this issue. Further, multiple comparisons were performed using the Kruskal-Wallis test of any pair of healthcare subsectors. In this case, the test was identical to the Mann Whitney U test with normal approximation. Again, results with  $p < 0.05$  were declared significant (Table 3.).

**Table 3.** Multiple comparisons of healthcare subsectors

The parameter: Our organization focuses on protecting the natural environment as a stakeholder				
Pair	Difference	H statistic	Critical value	p
X <sub>1</sub> -X <sub>2</sub>	2	17.33	5.73	$p < 0.000$
X <sub>1</sub> -X <sub>3</sub>	2	1.90	5.73	$p > 0.05$
X <sub>2</sub> -X <sub>3</sub>	0	0	5.73	$p > 0.05$

In relation to the focus on protecting the natural environment as a stakeholder, statistically significant differences were found in one pair of healthcare subsectors: pharmaceutical and primary healthcare subsector ( $p < 0.01$ ). In other two pairs of healthcare subsectors: (1) pharmaceutical and secondary and tertiary healthcare subsector, and (2) primary healthcare and secondary and tertiary healthcare subsector, no statistically significant difference was found ( $p > 0.05$ ).

## DISCUSSION

The level of natural environment protection as a stakeholder in Serbian healthcare system is investigated in this research paper. Empirical findings show that the natural environment is still neglected by many Serbian healthcare organizations, and healthcare corporate attention on natural environment protection is still in a transitional stage. Currently, there is not that adequate natural environment focus. This is more obvious with primary healthcare organizations, comparing to secondary and tertiary healthcare organizations and pharmaceutical organizations.

Overall, the not so high levels of protection of the natural environment as a stakeholder show that many healthcare organizations in the Republic of Serbia do not recognize environmental orientation and environmental strategy as a way to foster sustainability, profitability and competitiveness of their operations. This is not the lonely research result. Recent study conducted in Brazil, discovered the unsatisfactory degree of maturity of Brazilian accredited hospitals in relation to sustainable practices, specifically the environmental dimension, suggesting that in other parts of the world the natural environment protection is not at the sufficiently high level in healthcare sector as well [19], posting the need for further research, especially in international context.

Research implication is that, even though most of Serbian healthcare organizations focus on protecting the natural environment as a stakeholder, evidently, there is an urgent need to elevate healthcare managers' attention to environmental protection issue. Healthcare organizations' managers' adherence to sustainability concepts are crucial to enable their implementation [26]. When taking into consideration recent research study results that demonstrated enviably high level of the importance of the natural environment for Serbian consumers [18], the urgency for environmentally elevating healthcare business practices in Serbia is more evident.

## CONCLUSION

This empirical research paper gives an overview of natural environment protection as a stakeholder within the healthcare sector in the Republic of Serbia. The natural environment protection as a stakeholder issue was considered, except from the general point of view of healthcare managers, also from the point of view of the specific healthcare industry business subsector, on the other side. Obtained results show that natural environment protection as a stakeholder in healthcare business world of Serbia has not reached the highest level of importance, raising research implication for Serbian healthcare managers, for developing and implementing environmentally-based business activities as insufficiently exploited source of sustainable competitive advantage on domestic market.

So far, pharmaceutical organizations place the greatest focus on protecting the natural environment as a stakeholder, followed by secondary and tertiary healthcare organizations, ending with primary healthcare organizations.

The scientific contribution of the conducted empirical research is reflected in identifying the importance of protecting the natural environment as a stakeholder for healthcare managers living and working in the Republic of Serbia, both in general, and by specific healthcare industry business subsector. The social contribution of the research refers to the possibilities of applying obtained results in practice. The analysis of research results should serve as a guideline and assistance to the management of healthcare organizations operating in the Republic of Serbia in creating successful environmentally-based business strategies, which should result in better positions on the Serbian market.

## REFERENCES

- [1] Aragón-Correa JA, Sharma S., A Contingent Resource-Based View of Proactive Corporate Environmental Strategy. *Academy of Management Review* 28, pp. 71–88, 2003.
- [2] Attanasio, G., Preghenella, N., De Toni, A. F., Battistella, C., Stakeholder Engagement in Business Models for Sustainability: The Stakeholder Value Flow Model for Sustainable Development. *Business Strategy and the Environment*, 31(3), pp. 860-874, 2022.
- [3] Babbie, E., Mouton, J., *The Practice of Social Research*. Cape Town: Oxford University Press, 2007.
- [4] Beck, D., Ferasso, M., Bridging 'Stakeholder Value Creation' and 'Urban Sustainability': The Need for Better Integrating the Environmental Dimension. *Sustainable Cities and Society*, 89, 104316, 2023.



- [5] Boyce, J., *Market Research in Practice*. Boston: McGraw Hill, 2003.
- [6] Cohen, L., Manion, L., Morrison, K., *Research Methods in Education*. London: Routledge, 2007.
- [7] Dillman, D.A., *Mail and International Surveys: The Tailored Design Method*. New York: John Wiley & Sons, 2000.
- [8] Eckelman, M.J., Sherman, J., *Environmental Impacts of the US Health Care System and Effects on Public Health*, *PLoS One*, 11, 6, e0157014, 2016.
- [9] Eckelman, M. J., Huang, K., Lagasse, R., Senay, E., Dubrow, R., Sherman, J. D., *Health Care Pollution and Public Health Damage In The United States: An Update: Study Examines Health Care Pollution and Public Health Damage in The United States*. *Health Affairs*, 39(12), pp. 2071-2079, 2020.
- [10] Freeman, R.E., *Strategic Management: a Stakeholder Approach*. Pitman: Boston, MA, 1984.
- [11] Haigh, N., Griffiths, A., *The Natural Environment as a Primary Stakeholder: The Case of Climate Change, Business Strategy and the Environment*, 18(6), pp. 347-359, 2009.
- [12] Hristov, I., Appolloni, A., Chirico, A., Cheng, W., *The Role of the Environmental Dimension in the Performance Management System: A Systematic Review and Conceptual Framework*, *Journal of Cleaner Production*, 293, 126075, 2021.
- [13] Jovanović, V., Crossett, S., Paunović, E., Šerović, R., Kuhling, J.G., Chandler, C. et al., *Improvement to the Quality of the Healthcare System – Safe Healthcare Waste Management*, *Tehnika*, 8, 3, pp. 11-16, 2008.
- [14] Jovanović, V.S., Tesink, J.B.G., Jovanović, D.V., Đonović, N.Ž., Jevtić, M.R., Matić, B.I. et al., *Development of Healthcare Waste Management in Serbia and Challenges in the Improvement of the Quality of Healthcare Services*, *Tehnika*, 14, 2, pp. 343-348, 2014.
- [15] Karlsson, M., Ohman, D.P., *Material Consumption in the Healthcare Sector: Strategies to reduce its Impact on Climate Change. The Case of Region Scania in South Sweden*, *Journal of Cleaner Production*, 13, 1071e1081, 2005.
- [16] Lenzen, M., Malik, A., Li, M., Fry, J., Weisz, H., Pichler, P. P., ..., Pencheon, D., *The Environmental Footprint of Health Care: A Global Assessment*. *The Lancet Planetary Health*, 4(7), e271-e279, 2020.
- [17] Mihailović, D., *Metodologija naučnih istraživanja*. Beograd: FON, 2012. (Serbian)
- [18] Milić, T., *Environmental Awareness as Corporate Competitiveness Factor: A Research from Serbia*, in: Starčević D, Marinković S, editors. *Business and Artificial Intelligence. SymOrg2020: Proceedings of the XVII International Symposium on Business and Artificial Intelligence; 2020 September 07-10; Belgrade, Serbia*. Belgrade: University of Belgrade - Faculty of Organizational Sciences, 2020. pp. 159-166.
- [19] Nascimento, G., Araujo, C.A.S., Alves, L.A., *Corporate Sustainability Practices in Accredited Brazilian Hospitals: A Degree-of-Maturity Assessment of the Environmental Dimension*, *Revista de Administração*, 52, pp. 26-35, 2017.
- [20] Nguyen, T. T., Grote, U., Neubacher, F., Do, M. H., Paudel, G. P., *Security Risks from Climate Change and Environmental Degradation: Implications for Sustainable Land Use Transformation in the Global South*. *Current Opinion in Environmental Sustainability*, 63, 101322, 2023.
- [21] Rasheed, R., Rizwan, A., Javed, H., Sharif, F., Zaidi, A., *Socio-Economic and Environmental Impacts of COVID-19 Pandemic in Pakistan—An Integrated Analysis*. *Environmental Science and Pollution Research*, 28, 19926-19943, 2021.
- [22] Saunders, M., Lewis, P., Thornhill, A., *Research Methods for Business Students*. Edinburgh: Prentice Hall, 2009.
- [23] Senay, E., Landrigan, P.J., *Assessment of Environmental Sustainability and Corporate Social Responsibility Reporting by Large Health Care Organizations*, *Public Health*, 1, 4, e180975, 2018.

- [24] Sherman, J. D., Thiel, C., MacNeill, A., Eckelman, M. J., Dubrow, R., Hopf, H., ... & Bilec, M. M., The Green Print: Advancement of Environmental Sustainability in Healthcare. *Resources, Conservation and Recycling*, 161, 104882, 2020.
- [25] Siregar, I., Zilkarnain, CSR-Based Corporate Environmental Policy Implementation. *British Journal of Environmental Studies*, 1(1), pp. 51-57, 2021.
- [26] Tudor, T.L., Bannister, S., Butler, S., White, P., Jones, K., Woolridge, A.C. et al., Can Corporate Social Responsibility and Environmental Citizenship be Employed in the Effective Management of Waste? Case Studies from the National Health Service (NHS) in England and Wales, *Resources, Conservation and Recycling*, 52, pp. 764–774, 2008.
- [27] Welman, C., Kruger, F., Mitchell, B., *Research Methodology*. Cape Town: Oxford University Press, 2005.



## NEW INDUSTRIAL REVOLUTION WITH INDUSTRY 5.0 LABEL

**Stanko P. Stankov<sup>1</sup>**

<sup>1</sup>University of Niš, Faculty of Electronic Engineering, Niš, Serbia

e-mail: [stanko.stankov@elfak.ni.ac.rs](mailto:stanko.stankov@elfak.ni.ac.rs)

**Abstract:** The term Industry 5.0 comes as a reaction to the loudly advertised worldwide Industry 4.0 - a technological revolution in which digitization of all sectors, automation, big data sets and the introduction of artificial intelligence in all areas of business play a dominant role. The strong emphasis on technological improvement is undoubtedly driven by the original goal of business - to reduce costs and maximize profits. Industry 5.0 is actually a natural continuation of already occurring changes in the direction of digitization and automation. Now that robotic systems are performing routine mechanical tasks, the role of humans is returning in a new light. In the concept of Industry 5.0, the creativity of workers comes to the fore. Figuratively speaking, if Industry 4.0 is "cold" - focused on innovation, data, machines, algorithms, technologies and new methodologies - then Industry 5.0 is "warm" - it emphasizes the human, social and environmental dimensions of production. The revolution of Industry 5.0 is personalization. The relationship, individual approach, compliance with the requirements of each different client are the focus of a new understanding of the new industry and modern services. While Industry 4.0 emphasizes the automation of every production and gives the impression that workers will soon become redundant, Industry 5.0 puts the worker in the center of attention, as a strong, valuable and valued individual with a high value in the functioning of the company. Sustainability refers to the ability to deal flexibly with change. Globalized markets and value chains are increasingly vulnerable to disruptive changes caused by e.g. with geopolitical changes (Brexit, trade wars, war conflicts, protectionism, etc.) and natural emergencies (pandemics, impacts of climate change, etc.). The industry of the future will need to be able to adapt quickly to changing circumstances so that key value chains consolidate their role as a sustainable source of prosperity. A sustainable industry can face vulnerabilities that occur at many levels, including facilities, supply networks and industrial systems.

**Key words:** industrial revolutions, big data, artificial intelligence, kobot, automation

### INTRODUCTION

From 2011 to November 2021, humanity is experiencing the fourth industrial revolution with technological and economic changes associated with the integration of innovations such as artificial intelligence, blockchain technologies, the Internet of Things, cryptocurrencies, automation tools, etc. The optimization of processes through these advances has significantly affected the reduction of employees in various industrial branches, causing concern and protests of workers. However, the fifth industrial revolution is focusing on people. An overview of industrial revolutions, with basic characteristics, is shown in Fig. 1. For industry to become a source of real prosperity, its real purpose must include social aspects and environmental considerations. This includes responsible innovative activity that aims not only to reduce costs or maximize revenue, but also to increase prosperity for all participants in the chain - investors, workers, consumers, society and the environment. Industry must be sustainable and develop circular processes that reuse and recycle natural resources and reduce waste generation and environmental impacts. Sustainability means reducing energy consumption and greenhouse gas emissions, preventing the depletion and degradation of natural resources to ensure that the needs of present generations are met without compromising the needs of future generations. Industry 4.0 focuses less on the principles of social justice and sustainability and more on digitization and technologies based on artificial intelligence. Rather than requiring workers to adapt their skills to rapidly changing technology, technology seeks to adapt the production process to the needs of workers, a hallmark of Industry 5.0.

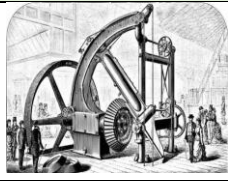


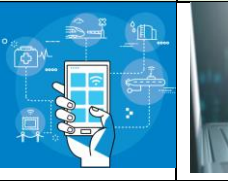

1.0 MECHANISATION	2.0 ELECTRIFICATION	4.0 AUTOMATION	4.0 DIGITALISATION	5.0 PERSONALISATION
				
The intraduction of industrial production equipment driven by water and steam power.	Mass production using electrical energy and assembly lines.	Automated production due to the rise of electronics, telecommunications and computers.	The use of cyber physical systems on connected devices to automate processes further.	The future is one in which humans and machines work synergistically. The Fifth Industrial Revolution, encompasses the notion of harmonious human– machine collaborations, with a specific focus on the well-being of the multiple stakeholders (isociety, companies, employees, customers).
1784.	1870.	1969.	2011.	2021.

Fig. 1. Basic features of previous industrial revolutions and Industry 5.0

Fig. 2 shows the transition from Industry 4.0 to Industry 5.0.



Fig. 2. Transformation of Industry 4.0 into Industry 5.0 [1]

An illustration of a production plant as a representative of Industry 5.0 is shown in Fig. 3. The plant is powered by renewable sources (in this case it is a wind farm). The worker performs tasks in cooperation with the cobot. Big data from IIoT sensors comes to the SCADA system, which is connected to the cloud infrastructure.



Fig. 3. Production plant in the light of Industry 5.0 [1]

The idea of Industry 5.0 is rooted in the concept of Industry 4.0 introduced in Germany in 2011 as a future project and part of the country's high-tech strategy, which will be accepted by business, science and decision-makers. Primarily, it looks at the extent to which the country succeeded in the first decade of the 21st century and how it could become more efficient, while the number of employees in production would remain stable. The focus is on ensuring better compliance not only with the economic but also with the special environmental requirements of green production, for industry with significantly reduced gas emissions and energy efficiency. In 2013, the German Academy of Science and Engineering (aacatech) presented a program of research and implementation recommendations developed at the initiative of the Federal Ministry of Science. The program describes the impact that the Internet of Things (IoT) will have on the organization of production thanks to the new interaction between people and machines [2]. Deutsche Bank has proposed that the implementation of Industry 4.0 becomes the standard for the world. Professor Klaus Schwab, the founder and president of the World Economic Forum, published two books in which he describes how Industry 4.0 is fundamentally different from all previous industrial concepts whose focus is technological progress [3]. The importance of research activities on the development of Industry 5.0 is shown in Fig. 4, while Fig. 5 shows the basic characteristics of this industry [4, 5].



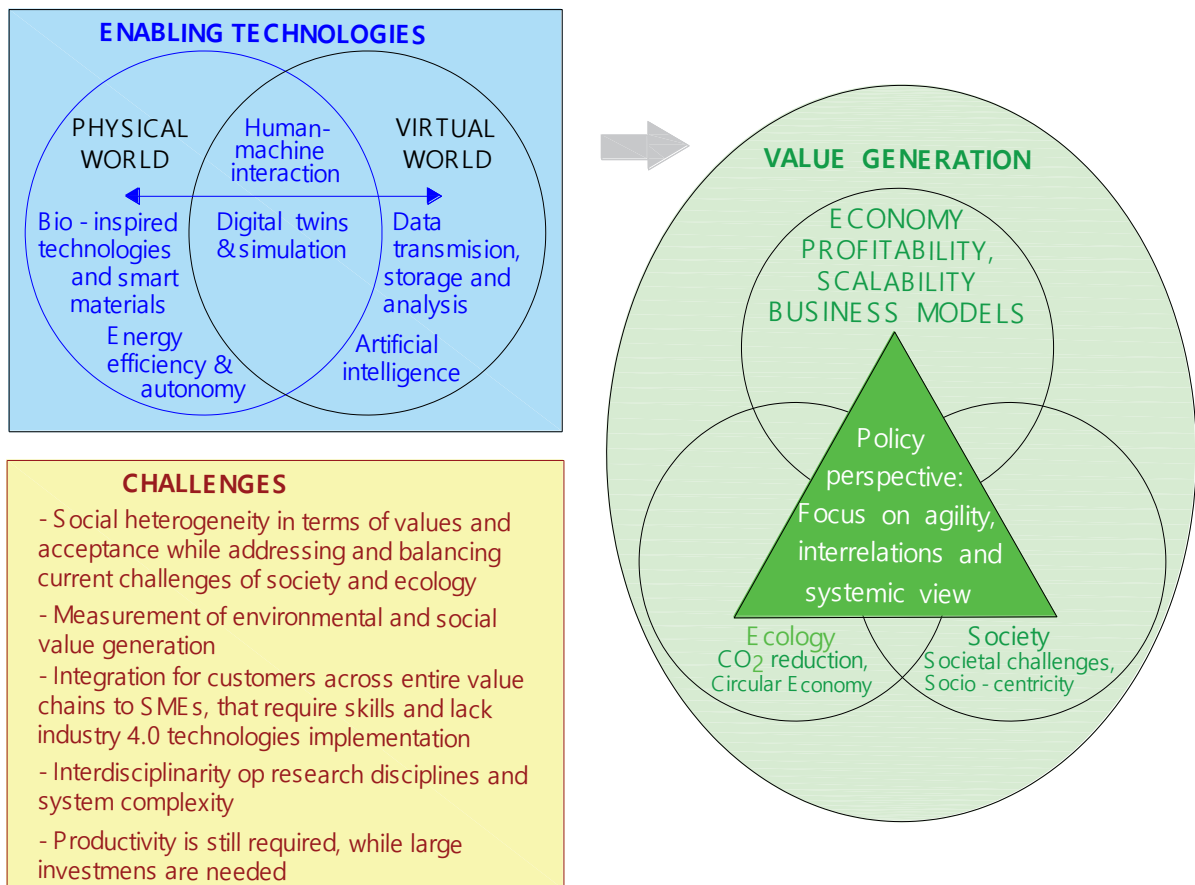
Fig. 4. Illustration of the impact of research on the development of Industry 5.0 [4]





**Fig. 5. Industry 5.0 – basic features [5]**

Fig. 6 shows the basic features of Industry 5.0 – goals, technological enablers, and challenges [6].



**Fig. 6. Goals, technological enablers, and challenges of Industry 5.0 [6]**

The road to Industry 5.0 starts with good planning, thoughtful strategies, open and inclusive communication and strong Industry 4.0 foundations. It's never too early to start transforming Industry 4.0 into Industry 5.0. First, it is necessary to find out what are the best solutions that meet the unique goals and challenges of a particular company. According to scientists at Australia's Deakin University, Industry 5.0 involves bringing workers back to factories and combining human intelligence and creativity with machine capabilities to improve process efficiency. While the main challenge in Industry 4.0 is automation, Industry 5.0 involves synergy between humans and autonomous machines.

**Table 1. Differences between Industry 4.0 and Industry 5.0**

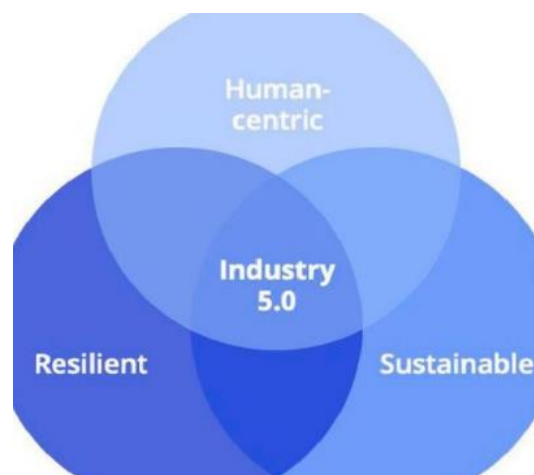
	INDUSTRY 4.0	INDUSTRY 5.0
GOALS	<ul style="list-style-type: none"> <li>- Smart manufacturing</li> <li>- Optimizing the systems and resources</li> </ul>	<ul style="list-style-type: none"> <li>- Human centricity</li> <li>- Sustainability</li> <li>- Social benefi</li> </ul>
SYSTEM APPROACHES	<ul style="list-style-type: none"> <li>- Ensures real-time data monitoring</li> </ul>	<ul style="list-style-type: none"> <li>- Technology utilization to advance human needs</li> </ul>
HUMAN FACTORS	<ul style="list-style-type: none"> <li>- Repetitive actions because of automated systems</li> <li>- No human interference with robots</li> <li>- Focuses on human-computer interaction</li> <li>- Complete virtual environment</li> </ul>	<ul style="list-style-type: none"> <li>- Ensures employee safety and management</li> <li>- Needs learning/training for employees</li> <li>- Focuses on human-robot interaction</li> <li>- Transitions back to an actual environment</li> <li>- Merges cognitive computing with human intelligence</li> </ul>

## TECHNOLOGIES WHICH ARE THE BASIS OF INDUSTRY 5.0

Technologies such as artificial intelligence and additive manufacturing, which optimize resource efficiency and minimize waste, can play a big role here. A greater degree of stability is needed in industrial production, by providing better protection against disruptions while being able to deliver critical infrastructure at critical times. Geopolitical changes and crises such as the COVID-19 pandemic and the war in Ukraine highlight the vulnerability of the current approach to globalized production. Industry 5.0 is based on technologies that represent a set of complex systems, each of which individually can realize its potential only if it is combined with the others. The first category includes customized human-machine interaction solutions that aim to connect people with technology, help people, and combine human-developed innovations with machine capabilities. The new technologies help people with physical and cognitive tasks: recognizing multilingual speech and gestures and predicting human intent; technologies for monitoring the mental and physical workload and stress level of employees; collaborative robots that work together with people and support their activities; augmented, virtual or mixed reality technologies, especially for learning and inclusion; increasing human cognitive abilities - technologies for combining the powers of artificial intelligence and the human brain (for example combining creativity with analytical skills), decision support systems. The second category includes technologies and smart materials inspired by biological organisms. These technologies and processes can be integrated with, for example, the following features: independent problem solving; simplified design; possibility of recycling; obtaining raw materials from waste; integration of living materials; integration of sensor technologies and biosensors and ergonomics. The third category uses digital twins and simulation technologies that can optimize production, test products or identify possible adverse effects, for example through digital twins of products and processes; virtual simulations and testing of products and processes (for example for



human orientation, safety at work); using multidimensional dynamic modeling and simulation; with the help of simulation and measurement of environmental and social impacts; cyber-physical systems and digital counterparts of entire systems; as well as by applying regular maintenance. Digital technologies have got a special role. While digital interconnectivity will facilitate the deployment of a range of sustainable technologies (including data acquisition, automated risk analysis and automated restrictive measures), increased reliance on digital technologies puts the industry at risk of technical disruptions resulting from failures and cyber-attacks. Researchs and innovation will play a key role in providing the necessary level of cyber security for a sustainable industry of the future. Technologies and smart materials inspired by biological organisms are applied. These technologies and processes can be integrated with, for example, the following features: independent problem solving; simplified design; possibility of recycling; obtaining raw materials from waste; integration of living materials; integration of sensor technologies and biosensors; ergonomics. Digital technologies will play a special role in Industry 5.0. While digital interconnectivity will facilitate the deployment of a range of sustainable technologies (including data acquisition, automated risk analysis and automated restrictive measures), increased reliance on digital technologies puts the industry at risk of technical disruptions resulting from failures and cyber-attacks. Researchs and innovation will play a key role in providing the necessary level of cyber security for a sustainable industry of the future. Industry 5.0 relies on three pillars (shown on Fig 7, based on the EU publication "Industry 5.0 People-Centred, Sustainable and Resilient").

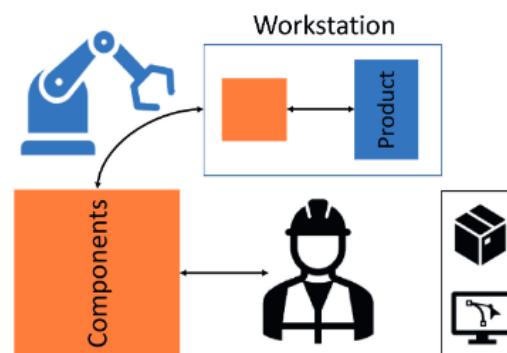


*Fig 7. The three pillars on which Industry 5.0 is based.*

## **COLLABORATIVE ROBOTS (COBOTS) IN THE SERVICE OF INDUSTRY 5.0**

An autonomous workforce will be receptive and informed about human intentions and desires. Humanity will work together with robots not only without fear, but also carefree, knowing that their "colleagues" - robots understand them adequately and are able to cooperate with them effectively. This will result in an efficient manufacturing process that will thrive in reliable autonomy, reducing waste and manufacturing costs. Industry 5.0 is changing the definition of robots, which until 2021 are perceived exclusively as programmable machines capable of performing repetitive tasks. In further development, robots evolve into an ideal human companion for performing tasks in some scenarios. This industrial revolution ushers in a generation of robots, commonly called cobots. They will know or learn quickly what to do with a human. These robots are "aware" of human presence and are able to meet safety criteria and take into account various operational risks. They notice, understand and feel not only the operator, but also his goals and expectations. Just like a student, cobots observe and learn how a person performs a task. Once trained, cobots perform tasks in the same way as human operators. Humans are expected to experience a sense of satisfaction while working alongside cobots. The purpose of cobots is not to replace

humans, but to take over extremely laborious or even jobs that are inherently risky and dangerous. Automation implies autonomous robots as intelligent agents that work simultaneously with humans in the same workspace. Trust and reliability between these two parties will achieve promising efficiency, seamless flexible production with minimal waste [7]. A new manufacturing role is expected to emerge within Industry 5.0: the Chief Robotics Officer (CRO). A CRO is a person who understands robots and their communication with humans. This individual will be responsible for making decisions to add or remove robots from the facility in order to achieve optimal productivity and efficiency. This individual is expected to have experience in robotics, artificial intelligence, human factor modeling, and human-machine interaction [7]. Industry 5.0 – and the cobots at its heart – is about combining people's creativity and craftsmanship with the speed, productivity and consistency of robots, and exploring how to make the very best of the many possible overlaps to mould hitherto unseen commercial and societal capabilities. From more people-centric, individually customized products to craftsmanship and specialist skills made much more widely available [8]. The use of such devices cooperating with humans directly on the shop floor applies to both business-critical and auxiliary processes (Fig. 8) [9].



**Fig 8.** Human – robot assembly system [10]

Collaborative robots are dedicated to direct interaction with humans, where manufacturing tasks are carried out together [11].

## CONCLUSION

The manufacturing of the future will lead to maximum connectivity people and machines. At its core, Industry 5.0 is oriented towards humans working together with robots and intelligent machines. Robots are already helping people work more efficiently, and Industry 5.0 is a process of coexistence and joint training of humans and machines. In industry, robots usually perform monotonous tasks such as welding, painting, loading and unloading heavy materials in warehouses and similarly. With the reduction of demand for human resources in such areas, people will have opportunities to develop their intellectual and creative potential, which is not focused on repetitive tasks, but on creating new value and developing innovative activities. Industry 5.0 is inevitable. The main feature of Industry 4.0 is the widest possible use of robots, big data and artificial intelligence in production processes. This is due to the transition to digital technologies, which enable decision making based on data on production processes in real time. In turn, this makes it possible to reduce production costs, improve product quality and ensure rapid distribution of goods that meet current market demands. Even as many jobs are expected to disappear as a result of Industry 4.0, there is a serious shortage of skilled labor in the industry. The lack of labor creates ideal conditions for the penetration of Industry 5.0 into production. Integrating robots in manufacturing will facilitate automation and create true human-robot collaboration. For employees in production, the principles of continuous development and self-learning will come to the fore. Corporate cultures will be built on the education and development of creative non-conventional thinking of staff working with robots. Robots will encourage and supplement this endless process of development. Technology will not slow down, and most likely its development will take place

even faster and more intensively over the years. By using technology, manufacturing employees will ultimately benefit. Industry 5.0 will create a collaborative environment that will affect efficiency and effectiveness in most aspects of production. One of the most important components of Industry 5.0 will be the human-machine interface. Robots will learn from humans, and humans will benefit from robots performing tasks that humans cannot or will not perform in manufacturing operations. Combining human intelligence with the cognitive capabilities of a technologically advanced work partner is a powerful combination for achieving superior results. The impact of Industry 5.0 should ultimately be positive. The COVID-19 pandemic has led to operational changes in industrial enterprises as hastily built short-term solutions have become the long-term status quo for many manufacturing operations. Among other things, the pandemic has also affected the organization's approach to cyber security and risk management. The war in Ukraine has significantly raised the levels of preparedness and proactive action in the field of infrastructure protection against cyber threats. It showed how intertwined the world's economies are and how vulnerable global supply chains are to both physical and cyber threats. Cyber security must remain adaptable to a challenging and complex reality. This is especially relevant today, when businesses and markets are influenced by factors such as the rapid pace of technological evolution and digital transformation through migration to cloud infrastructure, increasing opportunities and expanding the impact of IoT, accelerated deployment of 5G networks and services, advances in the field of artificial intelligence, improved edge computing capabilities and ever-increasing automation.

## REFERENCES

- [1] <https://avr-global.com/technical-articles/simplify-manufacturers-lives-with-industry-5-0/>
- [2] <https://en.acatech.de/publication/jahresbericht-2013/> (access September 2023)
- [3] Schwab, K., Thierry Malleret COVID-19: The Great Reset Paperback – July 9, 2020.
- [4] [https://research-and-innovation.ec.europa.eu/research-area/industrial-research-and-innovation/industry-50\\_en](https://research-and-innovation.ec.europa.eu/research-area/industrial-research-and-innovation/industry-50_en) (access September 2023)
- [5] <https://op.europa.eu/en/publication-detail/-/publication/aed3280d-70fe-11eb-9ac9-01aa75ed71a1> (access September 2023)
- [6] Müller, J., Enabling Technologies for Industry 5.0, Results of a workshop with Europe's technology leaders, September 2020.  
<https://op.europa.eu/en/publication-detail/-/publication/8e5de100-2a1c-11eb-9d7e-01aa75ed71a1/language-en> (access September 2023)
- [7] <https://www.universal-robots.com/blog/collaborative-robots-ushering-in-industry-50/> (access September 2023)
- [8] [https://www.tadviser.ru/index.php/Статья: Пятая\\_промышленная\\_революция\\_\(Industry\\_Индустрия\\_5.0\)](https://www.tadviser.ru/index.php/Статья: Пятая_промышленная_революция_(Industry_Индустрия_5.0)) (access September 2023)
- [9] Cohen, Y., Shoal, S., Faccio, M., Minto R., Deploying cobots in collaborative systems: major considerations and productivity analysis, International Journal of Production Research, Vol. 60, No 6., pp. 1815–1831, 2022.
- [10] Peron, M., Sgarbossa, F., Strandhagen, O., Decision support model for implementing assistive technologies in assembly activities: a case study, International Journal of Production Research, Vol. 60, No 4., pp. 1341–1367, 2022.
- [11] Male, J., Martinez-Hernandez, U., Collaborative architecture for human-robot assembly tasks using multimodal sensors, 20th International Conference on Advanced Robotics (ICAR), Ljubljana, Slovenia, 2021.



## THE INFLUENCE OF INFORMATION TECHNOLOGIES ON THE EFFICIENCY OF PRODUCTION CONTROL

**Vlado Medaković<sup>1</sup>, Bogdan Marić<sup>1</sup>**

<sup>1</sup>University of East Sarajevo, Faculty of Mechanical Engineering East Sarajevo, East Sarajevo, Bosnia & Herzegovina

e-mail: [vlado.medakovic@ues.rs.ba](mailto:vlado.medakovic@ues.rs.ba), [bogdan.marić@ues.rs.ba](mailto:bogdan.marić@ues.rs.ba)

**Abstract:** The efficiency of production planning and control is increased by the application of contemporary information and communication technologies. The influence of the existence of an information system on the entire functioning of a business system, as well as on the effectiveness of production planning and control, is generally known and does not need to be proven. The paper presents the effectiveness of production control of a particular product with the use of simulation software tools that are integrated with the production information system.

The basic space of the condition of the problem which the management of planning and production control should solve in the case of the production of a certain product will be presented tabularly.

**Key words:** production efficiency, production control, information system

### INTRODUCTION

The current trend in the field of business systems control is the integration of management efforts at all levels of the management hierarchy of a business system, in order to achieve the set business goals. Utilising the performances of modern information and communication technologies, with the use of modern management strategies in order to implement the mentioned integration, is one of the current challenges faced today by experts from various scientific disciplines [1,2,3,4]. The notion of integration of the structure and behaviour of a business system is a higher level abstraction, something that is strived for and achieved only in part by the fusion of those aspects of the structure and behaviour of the business system and different management strategies into the control model, i.e. into the information system of the business system. It is considered that the integration should be carried out on two levels: internal - at the level of the business system and external - at the level of communication with the hierarchically superior system, i.e. the market environment [1,4,5,6]. The latest research in the field of modern cybernetics is aimed at the building of a model by which it is possible to establish a communication with the system we want to manage. In the study of complex systems, evolutionary mechanisms of cyclical nature are noticed, which enable the maintenance of the existing state space, adaptation to new requirements of a hierarchically superior system and self - organization [7]. The mentioned evolution indicates the dynamic nature of real systems and is presented by unpredictable patterns of growth of structural and functional complexity at all hierarchical levels. It is concluded that the behaviour of the system is directed towards some future state, which is not deterministic and predictable from the aspect of the observer. The knowledge on possible future states of a production system, and, by means of that, the increase of the elements of predictability and determinism, is achieved by applying simulation software. In this way, the probability of timely implementation of the set goals is significantly increased, as well as the effectiveness of the management of the production planning and control process. The modelling of a real system with the help of modern information technologies and the designing of an information system and simulation software in order to increase the effectiveness of planning and production control imply the analysis of the structure and behaviour of the observed system, registration of acquired knowledge by using verbal, graphic, mathematical or logical models

and translating these models into the code of appropriate software. In all three mentioned phases, which present only the tip of the iceberg, the basic problem is to overcome the complexity. The basic model of the structure and behaviour of a business system is an appropriate information system that provides management with data on the current state of the system, generates reports necessary for making the control decisions, creates the plans which initiate and direct the behaviour of the business system in the upcoming period and automates certain business processes and activities. It should be noticed that the information system is a static model of the structure and behaviour of the business system, which does not provide management with the ability to predict which is necessary to make timely control decisions that lead to optimal system behaviour and full utilisation of its performances. The stated shortcoming of this model is especially visible in the decision-making at the tactical or operational level of production planning and control. In response to the mentioned requirements, it is inevitable to use a dynamic simulation model that will provide management with the necessary information about the structure and behaviour of the system at the tactical level and unambiguously direct their control decisions [1,2,8,9].

### ANALYSIS OF THE INFLUENCE OF INFORMATION TECHNOLOGIES ON EFFICIENCY

The basic space of the state of the problem that the management of planning and production control should solve in the case of production of a certain product will be presented tabularly. Solving of the given problem follows the following scenario. Twenty work orders have been formed and are awaiting their final termination and launch. The system should process six different types of products with similar characteristics so that the preparatory-ending times are balanced and minimally affect the main time of the flow of parts through the system. According to the given delivery deadlines and other criteria obtained from the top management, each work order is assigned an appropriate priority. The products are delivered to different customers and the basic criterion for defining the size of a batch is the agreed delivery time. Since there is a two-way communication with the process of procurement, transport and sales, the response times of the supplier (procurement time in Table 1) as well as the time of delivery of the product to the customer (delivery time) are available.

**Table 1.** Basic information about the work order

Priority of work order	Type of product	Batch (pieces)	Delivery deadline (in days)	Procurement time (in days)	Delivery time (in days)
1	4	1350	15	5	7
2	1	980	22	5	10
3	1	2700	18	5	3
4	2	800	23	6	1
5	6	2650	26	6	3
6	6	1500	27	7	4
7	3	1200	28	6	4
8	6	1600	35	5	2
9	3	1000	41	5	7
10	1	1300	38	7	2
11	2	3700	46	5	2
12	4	1450	49	7	4
13	2	2750	49	7	2
14	3	2000	55	5	3
15	4	1600	63	5	7
16	1	1800	71	5	2
17	5	1300	84	6	1
18	4	950	92	5	3
19	2	3500	114	5	1
20	2	1000	124	5	6

The management of the production planning and control process analyses the data and enters them into the simulation software in order to perform a simulation experiment. Without the existence of the simulation software, production would be launched according to the given priorities of work orders. After conducting the simulation experiment, the management received the following data from the simulation software given in Table 2:

**Table 2.** Results of the first simulation experiment

	Logging in the system (day-hour-minute)			Logging out of the system (day-hour-minute)		
	1.	0	0	0	4	0
2.	0	0	1	2	7	23
3.	0	0	2	10	4	53
4.	2	1	57	5	6	32
5.	3	0	26	13	3	17
6.	4	3	53	13	7	9
7.	6	3	28	15	6	30
8.	8	2	29	18	0	40
9.	9	4	24	18	2	31
10.	9	4	48	21	2	6
11.	11	6	30	28	7	27
12.	11	7	15	25	0	11
13.	13	1	50	32	4	33
14.	15	4	51	33	2	37
15.	20	0	22	41	6	41
16.	20	4	6	37	1	59
17.	20	4	17	41	7	10
18.	24	4	12	43	2	32
19.	25	9	23	49	3	42
20.	27	1	49	45	5	22

The analysis of the obtained results registers the entry and exit from the system of each work order and shows the total completion of all work orders with the exit of the work order with priority 19 from the system in 49 days 3 hours and 22 minutes. The analysis of time reserves provided by the simulation software is accessed in order to register possible delays. After concluding that it is a valid schedule, another simulation experiment is accessed in order to optimize the obtained schedule. After the analysis of the Gantt chart, the priorities of work orders are changed, the priority of the work order with ordinal number 19 is changed to priority 17, as well as the priority with ordinal number 16 to 14. After the entry of the given data, another simulation experiment is accessed, which provides management with the results shown in Table 3.

**Table 3.** Results of the second simulation experiment

	Logging in the system			Logging out of the system		
	1.	0	0	0	4	1
2.	0	0	1	3	0	49
3.	0	0	2	10	5	49
4.	2	1	57	5	7	27
5.	3	0	26	13	4	12
6.	4	3	53	14	0	35
7.	6	3	28	15	7	25
8.	8	2	29	18	1	36
9.	9	4	24	18	3	26



10.	9	4	48	21	3	2
11.	11	6	30	29	0	52
12.	11	7	15	25	1	7
13.	13	1	50	32	5	29
14.	15	4	51	33	3	32
15.	20	0	22	36	2	21
16.	20	4	6	37	7	24
17.	20	4	17	39	3	40
18.	23	7	3	40	0	4
19.	24	2	24	45	2	22
20.	25	0	2	43	4	27

The analysis of time reserves is accessed again, in order to register possible delays. After concluding that this is a valid schedule, the next simulation experiment is accessed in order to optimize the obtained schedule and the total completion of all work orders is noticed, with the exit of the work order with priority 19 from the system in 45 days 2 hours and 22 minutes. The obtained results indicate that the flow time of all work orders has been reduced by 4 days 1 hour and 20 minutes. After additional analysis, the work orders are launched according to an optimized schedule. The next task is to communicate with the sales and procurement processes, which use the results obtained from the simulation software to schedule the procurement, schedule the delivery of products to the customer and receive the new orders from the customers.

### Benefit analysis

Similarly to the way in which the production delays cause a domino effect of work order delays, the presented unburdening of the workshop also enables many benefits and thus increases the effectiveness of production planning and control.

In the given example, there is a batch production with a horizon of operational planning of about two months, so that the saving of four working days entails many positive consequences.

The first and obvious is the unburdening of the workshop capacity and the possibility of accepting new orders, which affects the increase of productivity, i.e. of the profit as a strategic goal.

If we take into account that there are the products with similar characteristics and that the initial plan was to produce 35,130 parts for the same time interval and that it is now possible to produce another 2,330 pieces in the same interval, there is a 6.6 percent increase of the plan. Since the system follows the basics of Lean production and produces only for a known customer, these are sold products.

In the above example, the increased turnover of stocks on an annual basis is obvious. The simulation software connects sales and procurement, sales engages production indirectly through sales plans which are translated into production plans, while procurement plans are generated on the basis on production plans. The simulation software directly affects the scheduling of procurement and sales by creating the production schedules and by generating the forecasts for the implementation of work orders.

The example also indicates very clearly the reduction of time from the launch of the work order to the implementation of the finished product ready for delivery, which is also a measure of the effectiveness of the production planning and control process.

The simulation software creates the time reserves in relation to the delivery time of products to customers, recognizes when they are negative and, in that case, performs the retermination of production. Also, the cooperation with the procurement, from which the supplier responds are obtained, on the basis of which it warns the procurement to order semi-finished products in a timely manner, enables the reduction or elimination of delays caused by the shortage of raw materials.



In that way, there is an obvious influence of the simulation software on the increase of the percentage of timely deliveries of products to customers as well as on the decrease of the percentage of work orders that have been implemented later (modified - divided) due to lack of materials.

For the same reason, if the production goes according to plan, there are no delays, unfinished production and delivery delays due to lack of raw materials, it is possible to optimize the deliveries and reduce the number of suppliers of finished products to customers. If one order is partially implemented, it implies multiple delivery, and that increases the operating costs of the system.

The simulation software gives the flexibility to the entire system which allows a quick response to unplanned events in the system, changes in the rhythm of production as well as the introduction of the new and improvement of the existing products.

The next benefit is a more efficient use of employees. The simulation further offers the possibility of predicting the workload of workers in a given period and balancing their workload by reallocating tasks in order to increase productivity. This fact has also been used to reduce the unplanned overtime.

The analysis of the obtained Gantt charts and other output results clearly shows the bottlenecks in production, and, in this example, those are the welding machines. By the procurement of another such machine, the production would be greatly unburdened and the average flow time of work orders through the system would be reduced by up to 40%.

The last criterion for assessing the effectiveness of the production planning and control process is the cost of production per unit of a product.

In the text that follows, there is an analysis of the influence of the obtained simulation results on production costs, which are significant from the aspect of increasing the effectiveness of the production planning and control process.

### Cost analysis

The production costs of a unit of product according to the proposed methodology consist of: processing costs, energy costs, premises costs, costs of refrigerants and lubricants, steam, water and air costs and costs related to separation and contribution.

Processing costs consist of costs related to the worker (R), the tool (A) and the machine (M).

$$V_o = R + A + M = n \cdot k_1 \cdot t_k + \left( n \cdot k_1 \cdot t_1 + k_2 \cdot t_2 + \frac{C_a}{i+1} \right) \cdot \frac{t_g}{T} + \frac{C_m \cdot P}{\sum_{i=1}^l (q \cdot t_k)_i} \quad (1)$$

Thus the costs related to workers are equal to:

$$R = n \cdot k_1 \cdot t_k = \left( 1 + \frac{k_3}{k_1} \cdot \frac{N_1}{N_2} \right) \cdot k_1 \cdot t_k \quad (2)$$

In equation (2), the values  $k_1$  and  $k_3$  are the gross personal incomes of a production and professional worker,  $N_1$  and  $N_2$  represent the number of machines serviced by the production and professional worker, and  $t_k$  is the duration of all production operations, i.e. the production time.

From the structure of this type of costs and for the stated workshop configuration, we can conclude that the increasing of the level of efficiency does not affect this type of cost, i.e. the costs will remain at the same level despite the increase in production and sales. On the other hand, if more is produced and sold in the same period (about 45 working days, or two months), it is obvious that the total costs per unit of the product are reduced.

The costs associated with the tool are:

$$A = \left( n \cdot k_1 \cdot t_1 + k_2 \cdot t_2 + \frac{C_a}{i+1} \right) \cdot \frac{t_g}{T} \quad (3)$$

In form (3),  $k_2$  represents the gross personal income of a sharpener,  $C_a$  the value of the cutting tool,  $t_1$  the tool replacement time,  $t_2$  the tool sharpening time,  $t_g$  the effective cutting time,  $T$  the tool stability,  $i$  the number of possible tool sharpenings.

These costs will be slightly increased due to the increased consumption of the tool in the observed interval, because in the same interval a larger number of workpieces is processed, so that the production volume is increased. It can be assumed that they are proportional to the growth of production volume and do not affect the costs per unit of the product.

The costs related to the machines are:

$$M = \frac{C_m \cdot p}{\sum_{i=1}^l (q \cdot t_k)_i} \quad (4)$$

In form (4):

- $C_m$  - represents the value of a machine in [BAM],
- $p$  - is the depreciation rate,
- $\sum_{i=1}^l (q \cdot t_k)_i$  - the total performance of one operation during a year and
- $l$  - the number of different production operations that are performed on the machine during the year.

With this type of cost, it is clear that with the increase in the number of performed operations, this type of cost decreases, which indicates that it has a positive effect on reducing the costs per unit of the product. In addition, the return on investment in the purchase of the machine is decreased.

The basic data for the stated model of costs and in accordance to the stated notation are shown in Table 4.

**Table 4.** Input data of the model of costs

$k_1$	$k_2$	$k_3$	$N_1$	$N_2$
0,076	0,076	0,085	1	4
$t_k$	$t_1$	$t_2$	$t_g$	$T$
15	25	18	3.75	1400
$C_a$	and	$C_m$	$p$	$t_{kgod}$
1800	12	15000	0.05	4000

Table 5 shows the values of processing costs before and after the optimization of the schedule.

**Table 5.** Values of processing costs before and after the optimization of the schedule

	$R$	$A$	$M$
First schedule	1.4551	0.3810	0.0469
Optimized schedule	1.3533	0.3810	0.0436

## RESULTS AND DISCUSSION

By analysing the obtained results, it can be concluded that the obtained costs are in accordance with the type of production (batch), types of machines and workshop configuration.

Other costs from the structure of processing costs can be considered as constant costs if we take into account the impact of changes in the number of pieces made in the appropriate time interval.

Batch-related production costs include additional costs of the pre-adjustment of the tool, preparation costs, control costs, and machine preparation costs.

The labour costs of the worker engaged in the pre-adjustment of the tool are:

$$V_{dpa} = \frac{V_o}{V_{osr}} \cdot \sum_{i=1}^l (t_{pa} \cdot LD_{pa})_i \quad (5)$$

where:

- $\sum_{i=1}^l (LD_{pa})_i$  [BAM] - gross personal income of workers on the pre-adjustment of the tool
- $t_{pa}$  [min] - time of the pre-adjustment of the tool for the complete production

Costs related to the labour of a control worker are:

$$V_{dk} = \frac{V_o}{V_{osr}} \cdot \sum_{k=1}^{l1} (t_{kon} \cdot LD_{kon})_k \quad (6)$$

where:

- $\sum_{k=1}^{l1} (LD_{kon})_k$  [BAM / min] - gross personal income of a control worker
- $t_{kon}$  [min] - total control time

Costs related to the work of a preparation worker are:

$$V_{dpr} = \frac{V_o}{V_{osr}} \cdot \sum_{i=1}^{l2} (t_{pr} \cdot LD_{pr})_i \quad (7)$$

where:

- $\sum_{i=1}^{l2} (LD_{pr})_i$  [BAM / min] - gross personal income of a preparation worker
- $t_{pr}$  [min] - preparation time

For the values of gross personal income of workers on pre-adjustment, control and preparation of BAM 0.085 per unit time (minute) and pre-adjustment times of batch (35 min per the batch), control (7 min per the batch) and preparation (25 min), production costs related to the batch are BAM 0.017 per unit of the product. The third part of the production costs, which refers to the complete volume of production, includes the purchase price of the simulation software.

Depending on the system configuration and other characteristics, the price of simulation software varies in relatively narrow limits and can be calculated with the amount of BAM 10,000. In that way, for an annual production volume of 200,000 units of the product, the procurement of simulation software burdens the price of a unit of the product with BAM 0.05.

## CONCLUSION

The role and importance of designing quality software solutions, that is, in the final context of this paper, of the simulation software as a dynamic model of production planning and control, can be clearly seen in the global view of the functioning of the entire social system.

The organization of the contemporary social community, i.e. the state, is based on production as the basic human activity in it. It is clear that the level of development of a social system, as well as the level of quality of life of the people who live and work in it, is directly dependent on the level of development of the economic system. The most obvious measure of the efficiency of the functioning of any business system is the economic criterion which justifies its existence, as well as the realised profit (or profit).

In order for a business system to be effectively controlled, that is, for the system to implement successfully the appropriate processes and activities, it is necessary for the management to have the appropriate information at all times. This information must be accurate, available in a timely manner, in the required format and current, i.e. to describe the actual condition of the system. This information provides the management with a control model, and the control model is an appropriate software solution or set of software solutions that make up the information system of a business system.

## REFERENCES

- [1] Arsovski, S., Arsovski, Z., Mirović, Z., The Integrating Role of Simulation in Modern Manufacturing Planning and Scheduling, *Strojniški vestnik - Journal of Mechanical Engineering*, vol. 55., 2009.
- [2] Bergman, B., Klefsio, B., *Quality from Customer Needs to Customer Satisfaction*, McGraw Hill Book Company, London, 1984.
- [3] Husby, C. P., Swartwood, D., *Fix Your Supply Chain - How to Create a Sustainable Lean Improvement Roadmap*, Taylor & Francis Group, New York.
- [4] Jugulum, R., Samuel, P., *Design for Lean Six Sigma: A Holistic Approach to Design and Innovation*, John Wiley & Sons, 2009.
- [5] Mann D., *Creating a Lean Culture*, Productivity Press New York, 2005.
- [6] Pohlman, R., Gardiner, G., *Value Driven Management: How to Create and Maximize Value Over Time for Organizational Success*, McGraw Hill, New York, 2000.
- [7] De Marco, T., *Controlling Software Projects*, Yourdon Press, Prentice Hall, Inc, Englewood Cliffs, New Jersey, 1989.
- [8] Bums, J., Morgeson D., An Object – Oriented World - View for Intelligent Discrete, Next-Event Simulation, *Management Science*, Vol. 34, No 12, 1988.
- [9] Currie, W., Hlupic, V., Change Management Panaceas and the Supporting Role of Simulation Modelling, *Proceedings of the WSC'2000 (Winter Simulation Conference 2000)*, pp. 2022-2028, Orlando, USA, 2000.



**XIII International Conference Industrial  
Engineering and Environmental  
Protection 2023 (IIZS 2023)  
October 05-06, 2023, Zrenjanin, Serbia**

---

# **Session 6**

# **Health and Environmental Protection**



## REMOTE AND OPEN PATH MONITORING TECHNIQUES APPLIED IN AIR QUALITY MEASUREMENTS IN URBAN AREAS

**Madalina I. Zot<sup>1</sup>, Aleksandar Djurić<sup>2</sup>, Francisc Popescu<sup>1</sup>, Bogdana Vujić<sup>3</sup>,  
Adrian Cioabla<sup>1</sup>, Una Marčeta<sup>3</sup>,**

<sup>1</sup>University Politehnica Timisoara, Timisoara, Romania

<sup>2</sup>City of Zrenjanin, Trg Slobode 10, post code:23000 Zrenjanin, Serbia

<sup>3</sup>University of Novi Sad, Technical Faculty "Mihajlo Pupin", Zrenjanin, Serbia

e-mail: [madalinazot@yahoo.com](mailto:madalinazot@yahoo.com), [aleksa@yahoo.com](mailto:aleksa@yahoo.com), [bogdana.vujic@tfzr.rs](mailto:bogdana.vujic@tfzr.rs)

**Abstract:** The planning of the air quality monitoring network primarily revolves around establishing the quantity and placement of stations, along with the monitoring techniques, while considering the goals, expenses, and the resources at hand. Usually, air quality monitoring networks are formed with point source gas analyzers, based on reference analytical methods, meaning single gas analysis per instrument. Alternative methods were developed for air quality monitoring, best results and applicability being given by open path spectroscopic methods, most relevant are shortly reviewed in this paper. Also, an application example by the authors is presented.

**Key words:** AQM, spectroscopy, DOAS, FT-IR, open path, pollution

### INTRODUCTION

Air pollution is a significant global issue that affects nations at various stages of development. The swift growth of the industrial sector and urbanization has led to the release of significant amounts of harmful substances and toxins into the air. Additionally, the need for transportation and mobility has driven the expansion of infrastructure to accommodate various vehicles, many of which are powered by internal combustion engines. Unfortunately, society often overlooks the fact that the environment has a finite capacity to absorb and process waste without significant alterations. In this context, every individual both contributes to and suffers from pollution. The main pollutants in ambient air of interest in air quality monitoring networks are: carbon monoxide, ozone, sulphur dioxide, nitrogen monoxide, nitrogen dioxide, hydrocarbons (VOC's), particulate matter (PM<sub>10</sub>), ammonia, hydrogen sulphide and many other. In the past decades, for main pollutants reference methods have been developed and implemented globally through ISO/CEI standards, providing a global normalization of methods used in air quality monitoring. The only disadvantage for these methods is the fact that each instrument is limited to detecting a single pollutant, consequently an AQM station being expensive to own and operate. The open path optical, spectrometric techniques are also expensive but with advantage that those instruments are capable to measure tens to hundreds of pollutants in the same time. The only disadvantage is given by, in some cases, relatively high detection limits. Optical techniques find extensive use in gas measurements across diverse industrial sectors and for environmental surveillance purposes [1]. Optical remote sensors for monitoring air pollutants in urban areas offer numerous benefits compared to point-sampling analyzers and laboratory assessments using collected samples. These advantages include the ability to simultaneously measure a broad spectrum of gases with a single instrument, conducting in-situ measurements that eliminate sample handling contamination, providing continuous real-time data, inherent calibration through spectroscopic data, and offering more representative ambient concentration values due to their extended measurement paths, which surpass the capabilities of traditional point samplers or monitors. [2]

FTIR - Fourier Transform Infrared and DOAS - Differential Optical Absorption Spectroscopy are extensively employed methods for investigating the chemical composition of the

atmosphere across a wide array of applications and platforms (including ground-based systems, aircraft, and satellites). The spectroscopic examination relies on the distinctive absorptions exhibited by molecules in both the infrared (IR) and ultraviolet (UV) regions of the electromagnetic spectrum.

## MATERIAL AND METHODS

### FTIR - Fourier Transform Infrared

FTIR (Fourier transform infrared) spectroscopy relies on measuring the extended absorption of infrared radiation as it travels between an artificial source and an infrared spectrometer. The method involves computing the total concentration through integration. When a Fourier transform is applied to the interferogram spanning a broad spectrum of wavelengths, it generates a distinctive gas spectrum that represents the gases present along the monitoring path. [3]

At the core of an FT-IR system lies the interferometer, with the Michelson interferometer being the choice for most commercial instruments, although there are exceptions. The recorded output from the interferometer is commonly known as an interferogram. This interferogram serves as the primary data output of an FT-IR spectrometer, encompassing comprehensive information about the spectrum. Nonetheless, the content within the interferogram isn't typically presented in a format readily understandable to most spectroscopists. To render the data more interpretable, the raw data undergo a transformation into a spectrum, which represents intensity plotted against wave number. This transformation is achieved through the application of a Fourier transform to the interferogram. In open-path FT-IR spectrometry, all quantitative data analysis relies on Beer's law. This law articulates that, for a consistent path length, the infrared energy passing through an absorbing substance decreases exponentially as the concentration of that substance increases. [4]

$$I(\nu) = I_0(\nu)c^{-\alpha(\nu)CL} \quad (1)$$

where  $I_0(\nu)$  is the intensity of the incident beam,  $\alpha(\nu)$  is the optical absorption coefficient of the target gas as a function of wave number ( $\nu$ ),  $C$  is the concentration of the target gas, and  $L$  is the path length.

In figures 1 and 2 the main setup possibilities for an OP-FTIR system are presented.

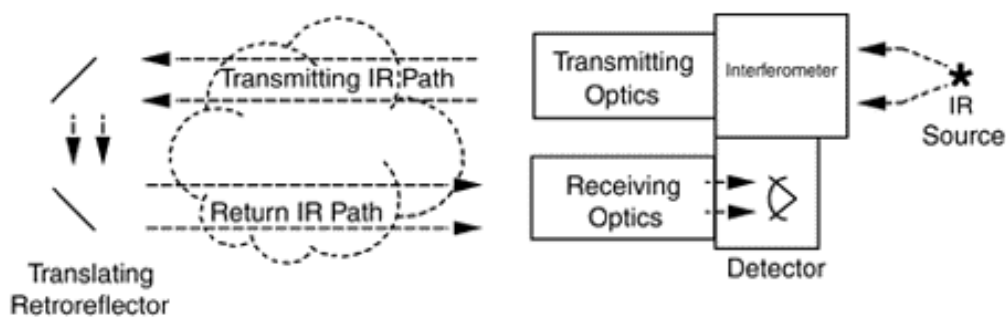


Fig. 1. Monostatic Configuration for Open-Path FTIR [5]



Fig. 2. Bistatic Configuration for Open-Path FTIR [5]



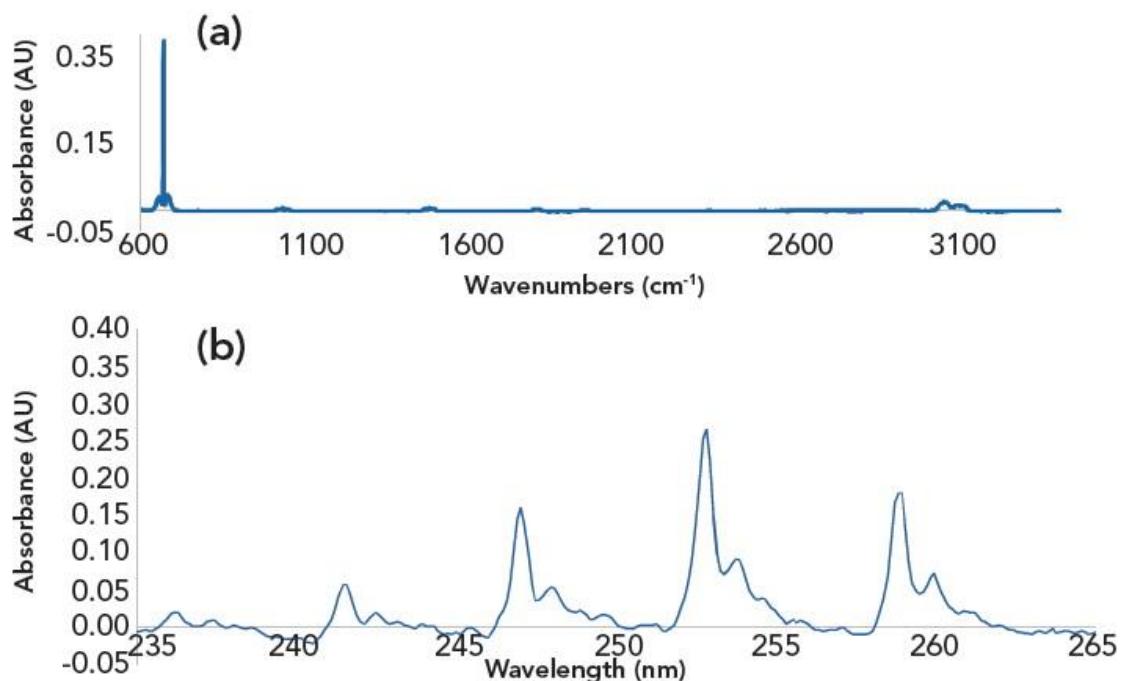
## DOAS - Differential Optical Absorption Spectrometry

DOAS (differential optical absorption spectrometry) quantifies the levels of gaseous pollutants by leveraging their unique capacity to absorb electromagnetic radiation. This technique analyzes a radiation spectrum spanning from the near ultraviolet to the near-infrared (from 250 nm to 2500 nm). The measured spectra are compared to reference spectra using the least squares method, enabling the differentiation of overlapping absorption features from various constituents.

DOAS offers the same benefits as many other spectroscopic methods, including natural calibration, the ability to detect concentrations at levels as low as sub-parts per trillion (ppt), high sensitivity, precision, specificity, operation without constraints due to physical boundaries, and the capacity for remote measurements. Specifically, DOAS is used to determine the concentrations of highly reactive species such as OH, NO<sub>3</sub>, BrO. Additionally, it can measure other species of interest in atmospheric chemistry, such as SO<sub>2</sub>, CS<sub>2</sub>, O<sub>3</sub>, NO, NO<sub>2</sub>, HONO, NH<sub>3</sub>, CH<sub>2</sub>O, and the majority of monocyclic aromatic hydrocarbons. [6]

The primary benefit of DOAS in the field of atmospheric remote sensing is its ability to non-invasively and simultaneously measure multiple trace gases. This is achieved by leveraging the distinct differential absorption cross-sections of various molecules, enabling the determination of mixing ratios through the measurement of optical density along extended light paths in the atmosphere, following the DOAS principle. [7]

In figure 3 a typical spectrum for benzene absorbance in IR and UV wavelengths (FTIR and DOAS) is presented.



**Fig. 3.** Representative benzene absorbance spectra in the (a) FTIR and (b) DOAS spectral analysis regions. [7]

## RESULTS: CASE STUDY

An example of application of an open-path air quality monitoring system is present in this chapter. The research idea started from the fact that, as in large airports across developed European nations, rigorous regulations and ongoing air pollution monitoring stations have been in operation for over a decade, while in developing countries, there is a lack of air pollution control measures in airports and their surrounding areas. For instance, the Romanian national air quality monitoring network comprises 117 automated stations, yet none of them are located in or near major airports.

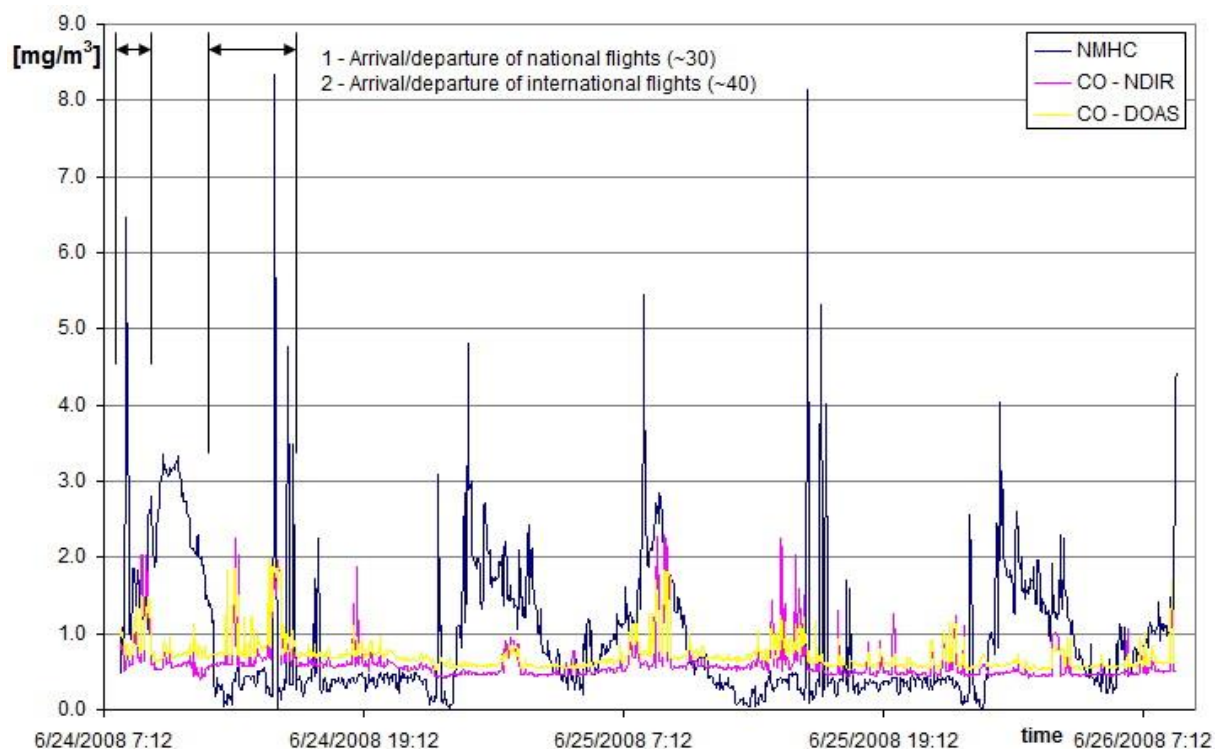
The measurements were conducted at Traian Vuia Airport Timisoara, a sizable regional airport situated in western Romania. Over the course of three days, measurements were taken for key air pollutants. To carry out these measurements, two mobile laboratories equipped with reference instruments, meteorological tools, and open-path instruments were employed. Both laboratories were positioned in close proximity to the airport apron.

The experimental setup was developed along airport taxiing lane (figure 4) by installing 2 reference laboratories (Univ. Politehnica Timisoara and National Institute of R&D for Optoelectronics) and two DOAS instrument's oriented in the same direction and parallel to airport landing lane, one with an open path of 60 meters and second of 300 meters.



**Fig. 4.** Timisoara international airport lane and DOAS (1 and 2) set-up.

Numerous pollutants were recorded, however, for present paper purpose only the CO results obtained with reference method instrument (NDIR) and alternative method (DOAS) and NMHC (non-methane hydrocarbons) are presented in figure 5.



**Fig. 5.** Timisoara international airport. NMHC, CO (NDIR) and CO (DOAS) recorded values [9]

One may observe a very good correlation between recorded values for CO concentrations with NDIR (reference) and DOAS (alternative) instruments. The data illustrated in the figure regarding NMHC concentrations highlights a significant issue. It is evident that elevated NMHC levels are observed during taxiing and between aircraft departures, implying that these levels may be attributed to volatile compounds escaping during aircraft refueling. This brings in the discussion the fact that open path instruments, capable to measure air pollutants

concentrations (especially benzene, toluene and xylene – cancerogenic NMHC) should be employed in fence-line type AQM systems.

## CONCLUSION

The use of novel air pollutants detection methods like open-path DOAS and FTIR spectroscopy is particularly suitable for swift assessments of air quality over large areas. An essential benefit of this approach is the capability to simultaneously and remotely detect a multitude of volatile compounds along the optical path through a single measurement. Nevertheless, the data acquired in open-path measurements can be influenced by the surrounding atmospheric conditions. Factors like meteorological variations, such as temperature fluctuations and humidity, as well as interferences from naturally occurring atmospheric substances like water vapor and CO<sub>2</sub>, have the potential to lead to misinterpretation of the data. Consequently, the need for sophisticated data processing techniques arises.

Open-path spectroscopy is recognized for its capability to offer immediate measurements of numerous substances along sampling paths that can stretch higher than 2000 meters. Progress in open-path monitoring technology and data analysis methods, in addition to evolving regulatory standards, have significantly enhanced the adoption and broad utilization of spectroscopy-based open-path measurements. One specific area of interest is the use of this technology in large industrial complexes near residential neighborhoods, as traditional stationary analyzers cannot match the spatial coverage provided by open-path instruments.

## REFERENCES

- [1] Hodgkinson J., Tatam P.R., Optical gas sensing: a review, *Measurement Science and Technology*, Vol. 24(1), pp. 012004, 2013.
- [2] Grutter M., Flores E., Air pollution monitoring with two optical remote sensing techniques in Mexico City, *SPIE*, vol 5571, 2004.
- [3] MCERTS, UK Environment Agency, Performance Standards for Open Path Ambient Air Quality Monitoring Systems using Differential Optical Absorption Spectrometry (DOAS) and FTIR Spectroscopy, Version 3, 2017.
- [4] Russwurm G.M, Childers J.W, FT-IT open-path monitoring guidance document, *ManTech Environmental Technology*, TR-4423-99-03, 1999.
- [5] US-EPA, Measurement and Monitoring Technologies for the 21st Century (21M<sup>2</sup>), Open path technologies, Washington, 2017.
- [6] Platt U., Air Monitoring by Differential Optical Absorption Spectroscopy, *Encyclopedia of Analytical Chemistry: Applications, Theory, and Instrumentation*, Wiley, 2017.
- [7] Nasse J.-M., Eger P.G., Pöhler D., Schmitt S., Frieß, U., Platt U., Recent improvements of long-path DOAS measurements: impact on accuracy and stability of short-term and automated long-term observations, *Atmospheric Measurement Techniques*, Vol. 12, pp. 4149–4169, 2019.
- [8] Schill S.R, McEwan R.S, Moffet R.C, Marrero J.E, MacDonald C.P., Winegar E.D., Real-World Application of Open-Path UV-DOAS, TDL, and FT-IR Spectroscopy for Air Quality Monitoring at Industrial Facilities, *Spectroscopy Outside the Laboratory, Spectroscopy*, Vol. 37(S11), pp. 18-22, 2022.
- [9] Popescu F., Evaluation of NMVOC emissions in airport areas, Recent advances in fluid mechanics and heat & mass transfer, *Proceedings of the 11th International Conference on Heat Transfer, Thermal Engineering and Environment (HTE '13)*, Vouliagmeni, Athens, Greece, pp. 102 – 1006, 2013.



## TEXTILE WASTE

**Jasmina Radosavljević<sup>1</sup>, Ana Vukadinović<sup>1</sup>**

<sup>1</sup>University of Niš, Faculty of Occupational Safety in Niš, Niš, Serbia

e-mail: [jasmina.radosavljevic@znrfak.ni.ac.rs](mailto:jasmina.radosavljevic@znrfak.ni.ac.rs)

**Abstract:** Textile recycling is the process of converting used or discarded textile materials into new products or fibers that can be used to produce new textiles. The purpose of this process is to reduce waste and conserve resources, considering that the textile industry exerts a considerable negative environmental impact. Textile recycling contributes to circular economy by extending the lifespan of textiles and by reducing the need for production of new materials. This encourages a more sustainable approach to consumption and production in the fashion industry. This paper discusses the generation, quantities, and handling of textile waste.

**Key words:** recycling, textile, waste

### INTRODUCTION

Clothing and textile industry has a 3-10% share in environmental CO<sub>2</sub> emissions. The textile production and consumption system has a substantial environmental, climate, and social impact. Production of clothing, footwear, and textile for household use ranks fourth in water use (following food, housing, and transport), second in land utilization, and fifth in the amount of emitted greenhouse gases.

Textile production and consumption are ever-expanding, as is their impact on climate, water and energy consumption, and the environment. Global textile production has almost doubled between 2000 and 2015, and the consumption of clothing and footwear is expected to increase by 63% by 2030, from the current 62 million tonnes to 102 million tonnes in 2030 [1].

Europe considers itself the global leader in what is referred to as circular economy. The European Green Deal provides a new circular economy action plan, adopted in March 2020. It emphasizes sustainable use of resources, primarily in textile and construction industries. The action plan envisioned the development of the EU Textile Strategy for 2021. In addition, the adopted EU Directive 2018/851 amending Directive 2008/98/EZ on waste requires all members state to introduce separate collection of textile waste through January 1, 2025, while ensuring that what has already been collected does not end up in incineration plants or in landfills.

Some EU countries introduced new regulations for the textile industry favoring the use of recycled materials. On March 30, 2022, the European Commission published the EU Strategy for Sustainable and Circular Textiles, which cites the EU action plan for higher sustainability and improved regulations in the textile industry. The goal of the European Commission for 2030 is to encourage consumers to invest in high-quality products and steer clear of fast fashion and to ensure that all textile products are durable, whether they are made of recycled materials or not. The EU strategy includes regulation of overproduction, reduction of microplastic pollution during production, and extended producer responsibility requirements to ensure that producers will act sustainably [1].

Fast fashion is characterized by frequent changes of fashion trends, a low-price policy, which stimulates consumerism and thus negatively impacts society as well as the environment. Fast fashion is not possible without faster production processes, resulting, among other things, in higher consumption and shorter lifespan of fashion products.

In times of growing consumerism, textile waste has become invasive, flooding the marketplaces, and Serbia does not have the infrastructure to treat the increasing textile waste, which is also very hazardous to the environment. Consumerist fashion arrived in Serbia together with the large fashion brands, which release up to 20 new collections per

year. Meanwhile, landfills throughout the world receive 235 billion tonnes of clothes. The textile industry is responsible for approximately 20% of water pollution and 35% of microplastic pollution in the environment. As much as 10,000 liters of water is required to produce a single pair of jeans and 2,700 liters to produce a single T-shirt [2].

The first official social study on the life cycle of clothing items in Serbia, conducted by the Environment Improvement Center, reveals that more than 80,000 tonnes of clothes are sold annually in Serbia, or almost 12 kg per person [2].

Globally, over 100 billion items of clothing are produced annually, most of which end up in incineration plants or in landfills. Only 15% of the clothes produced in Europe and the USA are sold, while the remaining 85% end up in landfills [8]. Decomposition of clothing may last up to 200 years. In the past, most clothes were sewn using pure cotton. Today, however, the prevalent fabric is polyester, a synthetic polymer whose decomposition time is significantly longer than that of cotton.

The textile industry relies on natural and synthetic fibers to weave or knit fabrics for clothing, furniture, or industry. Cotton production degrades agricultural land and pollutes water courses. About 22.5% of all insecticides and 10% of all pesticides applied globally every year are used for cotton cultivation [2].

Approximately 50% of discarded textile is suitable for recycling, but only a small portion is actually recycled or reused. In addition to households, textile waste is also generated in fiber production, clothing production, sales, etc. Textile waste has considerable recycling and reuse potential, as the global demand for discarded textile and clothing is growing, both for recycling and reuse, which is also an opportunity to generate profit [3].

Just as the textile industry is a billion-dollar business at the global level, so does textile waste management in developed countries generate profit for companies, provide financial support to non-government and charity organizations, secure thousands of jobs, and reduce the amount of discarded clothing and fabrics in landfills. In Serbia, collection and treatment of textile waste are only symbolic, since there are no recycling centers for textile materials. Serbian legislation still does not recognize textile waste and there are no systemic solutions available.

The global textile waste management industry is expected to grow further. In the USA, about 12 million tonnes of textile waste is recycled, which creates jobs for around 17,000 people. Considering that this is only 15% of the available textile waste for recycling, with 85% ending up in landfills, the textile recycling industry has ample room to expand its capacity and create even more jobs.

With regard to recycling and job creation, for instance, incineration of 10,000 tonnes of waste creates only one job, its disposal 6 jobs, while its recycling creates 36 jobs. Recycling helps build a stronger economy by lowering the cost of waste management, providing cheaper production materials, conserving energy, and creating new jobs. Recycling also helps protect the environment, because it reduces the risk of contamination from landfills, reduces pollution in general, and lowers the environmental impact of mining of new raw materials.

## **TEXTILE RECYCLING**

Globally, lifespan of used clothing is rapidly becoming shorter to give way to extremely affordable new clothing, all of which slowly evolves into a genuine environmental catastrophe. In addition to landfills and incineration plants being filled over capacity, the race for profit in the textile industry also leads to relentless consumption of natural resources in order to increase production.

As a secondary raw material, obtained from worn-out materials, cotton has a high economic value. Modern recycling procedures secure raw materials for the production of new products – an example of circular economy at work. A cotton product produced – profit earned; product bought, used, discarded – profit earned; product recycled – profit earned from the sale of new raw material; new product produced – new profit earned. The cycle continues without the need to use old and new agricultural plots and contaminate them with pesticides.



The materials used in textile recycling may be classified into two categories: pre-consumer and post-consumer textile waste.

Pre-consumer textile waste comprises by-products from the fiber and textile manufacturing industry, which are re-processed and used to produce yarns, clothing, mattresses, technical textiles for the automotive, furniture, and other industries. The waste from textile manufacturing processes includes fibers, felts, yarns, or residue from the making of textile or knitted fabrics. Such waste in companies with a full production cycle is often returned to the production phase after various recycling procedures. For that purpose, the waste needs to be sorted according to raw material composition and color. Afterwards, the textile waste is recycled by means of cutting and combing, then returned to the spinning process, and later used in knitting and weaving. If a material is not sorted according to its raw material composition, especially according to color, it can be recycled as felt, which can be used in construction as an insulating material or concrete strengthening material, in automotive industry (composite material, nonwoven fabrics for internal lining), in furniture industry (mattresses, upholstered furniture), as felt for disposable absorbents of impurities dissolved in fats (usually synthetic), and the like.

Post-consumer textile waste refers to the clothing and textiles that have been used and are no longer needed by their owners. This waste includes clothes that are donated, discarded, or collected through clothing return programs. Recycling of post-consumer waste is usually more challenging owing to different types of fabric and levels of wear and tear. However, advancements in recycling technologies increasingly allow the processing of post-consumer waste into new textile materials or their use in the production of carpets or textile fiber, which has a wide application as a filler, insulating material, or raw material for felt production.



**Fig. 1.** Ekosen HMC – prefabricated wall insulation panels made of recycled textile



**Fig. 2.** Recycled textile insulation



**Fig. 3.** Recycled blue denim insulation



**Fig. 4.** Recycled cashmere insulation

Textile recycling benefits circular economy by prolonging the lifespan textile and by reducing the need for production of new materials. This encourages a more sustainable approach to production and consumption in the fashion industry. Textile recycling involves the processing of used or discarded textile materials into new products or fibers to be used for production of

new textiles. The aim of this process is to reduce waste and conserve resources, since the textile industry can have a considerable negative environmental impact. In some EU countries, consumers have an option to dispose of their textiles in clothing banks, bring them to charity organizations, or give them away to be resold in flea markets.



**Fig.5.** Purses made of old coats and jackets

Textile recycling can be mechanical and chemical.

Mechanical recycling of textile waste is a method in which textile fabric decomposes while fibers are preserved. Once carded, the fibers can be spun to make new fabrics. This is the most common textile recycling technique and a process that is especially well-developed for cotton textile. Mechanical recycling protocols differ depending on the material, so that several stages of sorting are required before the process begins [3].

Textile needs to be separated according to fabric composition and color to avoid redyeing and bleaching. Once sorted, textile materials are shredded, washed, and separated into small fibers. The individual fibers are then aligned in parallel through combing in preparation for spinning. Some fibers, including cotton, need to be spun together with a carrier fiber to maintain high quality. Carrier fibers usually include cotton, organic cotton, or polyester. When the fibers are spun into new yarn, they can be used to create new textile. The process functions as a semi-closed recycling loop. The number of times a material may be recycled depends on fiber quality, which decreases with each mechanical processing cycle [3].

Mechanical processing can also be used with materials other than textile, a common example of which is polyester. In case of polyester, the materials recycled are plastic bottles made of polyethylene terephthalate (PET). Similar to textiles, plastics are sorted according to color and type at recycling facilities. The plastics are then shredded and washed to be broken down and cleared of contaminants. The dried plastic remains are shaped into PET pellets, after which they undergo extrusion to create new fibers. The new fibers can then be used to create new textiles [4].

Chemical recycling is used for synthetic fibers, such as polyethylene terephthalate (PET). Synthetic fibers can be broken down to create new fibers, yarn, and textiles. For PET, the starting materials are first broken down to a molecular level using chemicals that facilitate glycolysis, methanolysis, hydrolysis, and/or ammonolysis. This process of depolymerization also removes contaminants from the starting material such as dyes and unwanted fibers. After that, the material is polymerized and used to manufacture textile products [5].

Chemical recycling, as opposed to mechanical recycling, results in high-quality fibers that are similar to the original fibers. Therefore, no new fibers are required to support the product of the chemical process [5]. While other polymers such as nylon and cellulose-based fibers are produced using different chemicals and procedures, the general structure of the process remains the same [6].

## **TEXTILE RECYCLING IN SERBIA**

In Sremska Mitrovica there is a recycling facility spreading over an area of 2,000 m<sup>2</sup>, owned by Spildpro LLC, where more than 1,000 kg of various textile waste is recycled daily. The



recycled products are intended for cleaning in all branches of industry. So far, the recycled textile waste in Sremska Mitrovica has been used to manufacture industrial cleaning rags, which show a great production potential in Serbia, because almost 80% of industrial cleaning rags are imported. Out of the collected textile waste, 40% is used for industrial cleaning rags, because they are made of cotton and highly absorbent textile. The remaining textile waste is deposited in landfills.

In 2022, a plan was set in motion to put a new textile recycling facility in operation, which would enable additional 50% of textile waste to be recycled, leaving only 10% to be discarded. From next May, in addition to used clothes, the facility in Sremska Mitrovica will have the capacity to recycle all textile waste from the textile industry. The facility has the capacity of 300 tonnes of textile waste per year. Spildpro LLC management is planning to install textile waste collection bins all over Serbia. Another plan is to produce textile fibers with wide application as a filler, insulation material, and raw material for felt production. For example, industrial cleaning rags cannot be produced from winter jackets, but the jackets can be shredded to obtain fibers.



**Fig. 6.** Textile waste bin

RETEX is an innovative center for textile collection and recycling, established in 2010 as part of a program by the Women's Center in Užice. It is a result of recognizing the needs of vulnerable groups to find employment and the needs of local community to improve the quality of primary waste separation.

There is nowhere to dispose of textile waste in Serbia, because there are no bins placed for this specific type of waste. Every year, Serbia imports 80,000 tonnes of clothes, which is usually of low quality and quickly finds its way in a dumping site.

## **TEXTILE WASTE LANDFILLS**

Chile is the largest importer of used low-quality clothes in South America. It has been affected by the global rise of fast fashion. Most clothing donated by global fashion brands, which is in fact worthless, ends up in landfills across the world. Every week, out of 15 million items of used clothing donated to charities, almost a half is found to be worthless [7].

With the global consumption of clothes increasing, fast fashion – cheap low-quality clothing by well-known fashion brands – ends up in Korle Lagoon in Accra, the capital of Ghana, which is home to a mountain of discarded used clothes. The clothes, sent to Ghana to be resold and reused, usually come from charitable donations. Since the clothes are worn out and shabby, they end up at the dumping site. A portion of the clothes proceeds to other African countries, such as Ivory Coast or Burkina Faso. However, most of the clothes end up at Kantamanto market in Accra, the biggest African second-hand clothing market [7].

Only 15% of clothing produced in Europe and America is actually sold, while 85% ends up in illegal landfills. The largest textile landfill in the world is located in Alto Hospicio, Chile. More than 39,000 tonnes of used clothing imported each year end up in illegal landfills in the Atacama Desert, the driest desert in the world, with dire consequences for the environment and the local community. Pure cotton was once the dominant fabric in clothing production,

but today polyester prevails, a synthetic polymer whose decomposition time may last up to 200 years [7].

This landfill poses a threat to an entire unique desert biodiversity and to the health of all people residing in its vicinity. Since the law does not regulate how to handle textile waste, one option is to incinerate it, which results in smoke pollution, which is a serious issue, and in large-scale fires, which break out at least once a year [7].



*Fig. 7. Part of the clothing dumping site in the Atacama Desert, Chile*

## CONCLUSION

Clothing is one of the biggest contaminants of our planet. Sustainable fashion is based on clothing repair, giveaways, and purchase in second-hand stores. Yet, Serbia's import of second-hand clothing from the EU has been declared as the biggest generator of textile waste. Even so, the Statistical Office of the Republic of Serbia has no data on the amount of such clothing entering Serbia.

The price of fast fashion clothes keeps dropping, so people often buy them even when they do not need them while throwing away their old or rarely worn clothes. The issue is that new clothes are often made of cheaper materials, which are not easily recyclable but which heavily contaminate the environment. This is not an issue exclusive to Serbia, which has no laws to force customers and manufacturers to act more responsibly.

Textile has the greatest reuse potential. Unfortunately, there is no organized disposal and recycling of textile waste in Serbia, nor are there laws to regulate this area. Textile waste management in Serbia is therefore underdeveloped and there is no systemic solution provided within a legislative framework. The public is mostly concerned with other types of waste streams. It is necessary to introduce extended liability for both importers and producers of textile/clothing in the national legislation. They should be mandated to collect and safely dispose of specific amounts of clothing depending on the amount of clothing they release on the market.

## ACKNOWLEDGMENT

The paper is part of the research funded by the Ministry of Education, Science and Technology of the Republic of Serbia according to the Agreement on the implementation and financing of the scientific research work of NIO in the year 2023, Registration number of the Agreement 451-03-47/2023-01/200148.

## REFERENCES

- [1] EU Strategy for Sustainable and Circular Textiles, COM/2022/141 final.
- [2] Centar za unapređenje životne sredine, VREME JE ZA NOVU MODU!, Analiza istraživanja o životnom ciklusu odevnih predmeta u Republici Srbiji, Beograd, 2020.
- [3] Ribul, M., Lanot, A., Tommencioni P., C., Purnell, P., McQueen-Mason, S., J., Baurley, S., Mechanical, chemical, biological: Moving towards closed-loop bio-based

recycling in a circular economy of sustainable textiles. *Journal of Cleaner Production*, Vol. 326, (2021).

- [4] Fiber recycling using mechanical and chemical processes, Cattermole Consulting Inc. 2019-06-10.
- [5] Palmé, Anna, *Recycling of cotton textiles: Characterization, pretreatment, and purification*, Department of Chemistry and Chemical Engineering, Chalmers University of Technology Gothenburg, Sweden, 2017.
- [6] Hawley, J. M., Blackburn, R. S., *Understanding and improving textile recycling: a systems perspective*, Sustainable Textiles, Woodhead Publishing Series in Textiles, Woodhead Publishing, pp. 179–199, 2022.
- [7] Hanna de la Motte and A°sa O°stlund, *Sustainable Fashion and Textile Recycling*, MDPI, 2022.



## A SIMULATION MODEL OF AIR POLLUTANTS DISPERSION IN THE BELGRADE CITY AREA

**Adrijana Babić<sup>1</sup>, Zoran Čepić<sup>1</sup>, Jelena Radonić<sup>1</sup>, Borivoj Stepanov<sup>1</sup>, Zorana J. Andersen<sup>2</sup>**

<sup>1</sup>University of Novi Sad, Faculty of Technical Sciences, Novi Sad, Serbia

<sup>2</sup> University of Copenhagen, Dept of Public Health, Copenhagen, Denmark

e-mail: [adrijana.capko@gmail.com](mailto:adrijana.capko@gmail.com)

**Abstract:** Monitoring the atmosphere to identify and quantify pollutants is an increasingly critical aspect of comprehensive environmental surveillance. Both nationally and internationally, this multifaceted challenge of environmental monitoring at the geocomponent and geocomplex levels has garnered attention from experts across various fields, including chemists, physicists, geographers, biologists, and meteorologists. The Earth's atmosphere's unique characteristics, coupled with its potential role in mitigating climate change, have elevated the significance of air pollution monitoring. In Europe, the EARLINET system facilitates aerosol distribution control, and Serbia has recently adopted this system.

**Key words:** urban air pollution, air pollutants dispersion, monitoring

### INTRODUCTION

The European Union (EU) has long been at the forefront of global efforts to combat environmental challenges, recognizing the intricate relationship between human activities, environmental health, and sustainable development. With a commitment to fostering a greener and more sustainable future, the EU has established a comprehensive framework of regulations and directives that address a myriad of environmental concerns. These range from mitigating the impacts of climate change, ensuring water and air quality, managing waste effectively, to protecting natural habitats and biodiversity.

One of the pivotal areas of focus within this framework is air quality. Clean air is fundamental to human health and ecosystem vitality. However, rapid urbanization, industrial growth, and increased vehicular traffic in many European cities have led to deteriorating air quality, with pollutants posing significant health risks to urban populations.

In 2019, the Republic of Serbia, as part of its aspirations to integrate with the EU, showcased its dedication to environmental stewardship. By presenting its Negotiation position for Chapter 27 (Environment and Climate Change) to the European Commission, Serbia signaled its intent to transpose EU's rigorous air quality directives into its national legislation. This move not only aligns Serbia with European standards but also underscores the country's commitment to safeguarding the health of its citizens and the environment.

Central to Serbia's efforts in this domain is the National Register of Pollution Sources. This comprehensive database serves as a repository of information on various sources of environmental pollution. Managed by the Environmental Protection Agency, the register is an integral component of Serbia's Environmental Information System. Established in response to the growing demand for transparent and accessible information on pollution sources and emissions, the National Register aids state authorities in decision-making and policy formulation. Furthermore, it empowers the wider community, including researchers, policymakers, and the general public, with data that can drive informed discussions and actions on environmental issues.

## Review of methods used for air pollution measurements

To ensure compliance with air quality standards, EU Member States, as mandated by the EU Ambient Air Quality Directives (AAQDs), classify their territories into zones and agglomerations. These classifications are based on assessment thresholds for various pollutants, including sulphur dioxide (SO<sub>2</sub>), nitrogen dioxide (NO<sub>2</sub>), particulate matter (PM<sub>10</sub>, PM<sub>2.5</sub>), lead, benzene, and carbon monoxide. The AAQDs also necessitate the formulation of air quality plans in areas where pollutant levels exceed the set standards.

Internationally, EU Member States collaborate with other UNECE countries under the UNECE Convention on Long-Range Transboundary Air Pollution (CLRTAP). The CLRTAP inventory, distinct from the E-PRTR, focuses on transboundary air pollution and persistent organic pollutants. These inventories encompass all anthropogenic emission sources and are typically derived from national statistics.

Serbia ratified the CLRTAP and its associated protocols, as detailed in Table 1.

### UNECE Convention on Long-Range Transboundary Air Pollution (CLRTAP)

The CLRTAP, developed under the UNECE, is a significant international effort to address transboundary air pollution and persistent organic pollutants. The CLRTAP inventory is distinct from the E-PRTR. While the E-PRTR focuses on monitoring emissions from facilities, the CLRTAP was specifically designed to tackle pollutants that have cross-border impacts. These inventories encompass all anthropogenic sources of emissions to the air and are typically formulated using national statistics for activity data combined with national emission factors.

The Republic of Serbia demonstrated its commitment to addressing transboundary air pollution by becoming a party to the CLRTAP on 8 October 1991. Furthermore, Serbia ratified several protocols under the LRTAP Convention, including the Protocol on Long-term Financing of the Cooperative Programme for Monitoring and evaluation of the Long-range Transmission of Air Pollutants in Europe (EMEP), the Protocol on Heavy Metals, and the Protocol on Persistent Organic Pollutants. The detailed status of Serbia's ratification of international treaties under the CLRTAP is presented in Table 1.

**Table 1.** Status of ratification of international treaties under the CLRTAP in Serbia [1]

Treaty	Signed by parties	In force since	Ratified by Serbia
Convention on long-range transboundary air pollution (CLRTAP)	1979	1983	1991
Protocol on long-term financing of the cooperative programme for monitoring and evaluation of the long-range transmission of air pollutants in Europe (EMEP)	1984	1988	2001
Protocol on persistent organic pollutants	1998	2003	2012
Protocol on heavy metals	1998	2003	2012
Protocol to abate acidification, eutrophication and ground level ozone („Gothenburg Protocol“)	1999	2005	Postponed

### AERMOD Modeling

AERMOD, which stands for "AERosol MODel," is a state-of-the-art atmospheric dispersion model developed by the United States Environmental Protection Agency (U.S. EPA). It is designed to simulate the dispersion of pollutants in the atmosphere under a wide range of

meteorological and topographical conditions. AERMOD uses meteorological data from surface and upper-air stations. This data provides information on wind speed, wind direction, atmospheric stability, and other parameters that influence pollutant dispersion. In 2011, the Serbian Environmental Protection Agency (SEPA) adopted the AERMOD modeling technique to assess the spatial and temporal distributions of pollutants. The model was specifically employed to simulate the dispersion of pollutants emitted from various thermal energy sources in Serbia. The decision to use AERMOD was likely influenced by its ability to provide detailed insights into pollutant dispersion patterns, especially in regions with complex terrains or significant anthropogenic structures.

### **XGBoost Machine Learning Method**

The XGBoost method, a supervised machine learning ensemble technique, was employed to forecast the dynamics of BTEX concentrations in the air. This method combines the results of several individual decision trees. Specifically, in the XGBoost method, the boosting technique sequentially forms a series of small trees that classify the input data into classes based on the attribute values that describe the classes. Each subsequent tree is "trained" in iterations, taking into account the errors in the previous classification, aiming to supplement and improve the prediction. This method has been previously applied in Serbia for various environmental studies, showcasing its effectiveness in handling complex datasets and providing accurate predictions.

### **Data Collection and Analysis**

In Serbia, the "Regulation on monitoring conditions and air quality requirements" sets the standards for air quality assessment. While the regulation does not specify particular modeling techniques as reference, it acknowledges modeling as a supplementary tool to evaluate air quality. This approach aligns with global practices where modeling complements observational data to provide a comprehensive understanding of air quality dynamics. The City of Belgrade, as the capital and one of the largest urban centers in Serbia, has been proactive in addressing air quality issues. In 2021, the City Government adopted the "Air Quality Plan for the period 2021-2031." This document, available publicly, presents the results of modeling research and outlines strategies to improve air quality in the city over the next decade. The primary data for this study was sourced from both automatic and semi-automatic monitoring stations operational between 2017 and 2019. This observational data was enriched with modeled meteorological information derived from the Global Data Assimilation System (GDAS) [2], a renowned system for assimilating observational data into meteorological models. Several analytical methods were employed to interpret the collected data:

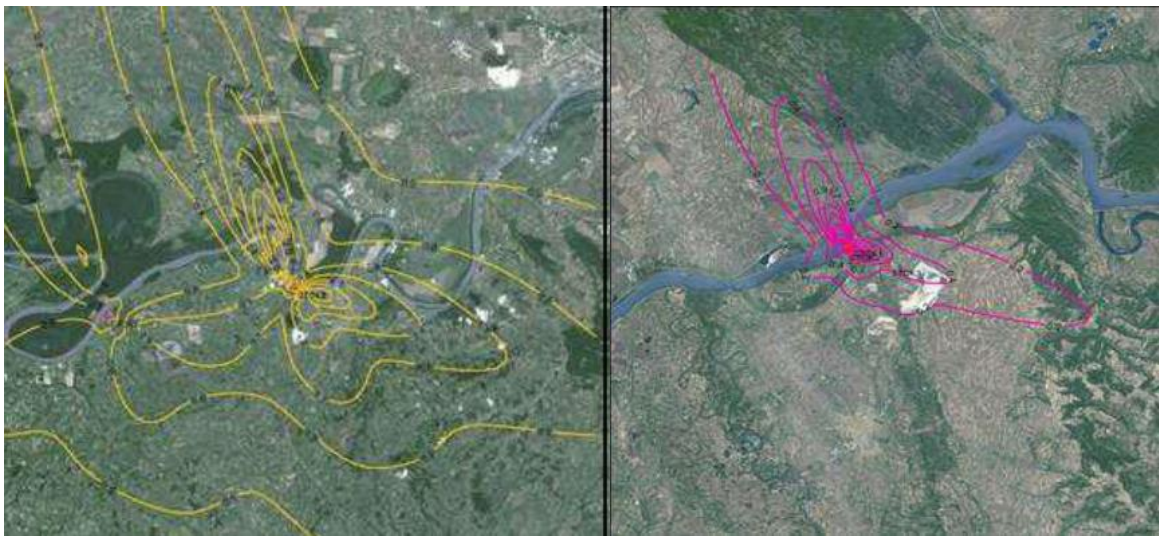
- CWBL Method [3]: The Concentration Weighted Boundary Layer (CWBL) method was utilized to analyze the contribution of regional transport to local air pollution levels. This method helps in understanding how pollutants from neighboring regions influence local air quality.
- Receptor Model EPA Unmix: For locations equipped with semi-automatic monitoring, the receptor model EPA Unmix version 6.0 was employed to identify dominant sources of air pollution. This model helps in pinpointing specific sources contributing to observed pollution levels.
- Software Tools: The data from monitoring networks was extensively analyzed using specialized software packages in the R programming environment, including openair, plotly, and leaflet. These tools facilitate advanced data visualization and statistical analysis. A significant aspect of the study was the use of receptor-oriented models as described by A. Stojić [4]. While the exact details of Stojić's work are not provided in



the initial text, it's evident that his methodologies played a pivotal role in assessing pollutant emission sources in the Serbian context.

## DISCUSSION

In 2021, a significant advancement was made in the field of air quality modeling in Serbia with the State Environmental Protection Agency (SEPA) adopting the AERMOD model. This model was specifically employed to map the spatial and temporal distributions of pollutants emitted from key thermal energy sources in the country. The study encompassed five major thermal power plants: "Nikola Tesla A and B" in Obrenovac, "Kostolac A and B" in Kostolac, "Kolubara A" in Veliki Crljeni, and the "Morava" thermal power plant in Svilajnac. A noteworthy observation from the study was the significant disparity between the modeled values and actual measurements. This discrepancy underscores the inherent challenges in modeling and emphasizes the imperative need for continuous refinement and validation of modeling techniques.



**Figure 1.** Modeled distributions of annual concentrations of sulphur dioxide from TANT A and B (left) and annual concentrations of particles from TE Kostolac A and B (right) [5]

Belgrade, the capital and the largest city in Serbia, was a focal point of this study due to its urban significance. An exhaustive analysis of the air quality in the Belgrade agglomeration was conducted using the XGBoost machine learning method, which was previously applied in Serbia for similar environmental studies. This method, known for its accuracy, was used to predict the dynamics of BTEX concentrations in the air based on meteorological data. The results revealed patterns in pollutant concentrations, helping identify potential hotspots within the city. Furthermore, the study delved into the diurnal and seasonal variations in pollutant levels, providing insights into potential external factors influencing these fluctuations.

Additionally, the receptor model EPA Unmix version 6.0 was utilized for locations where semi-automatic monitoring was performed. This model, combined with the insights from the XGBoost method and other software environment packages like R (openair, plotly, and leaflet), provided a comprehensive understanding of the dominant sources of air pollution in Belgrade. The findings underscored the need for targeted interventions, emphasizing the importance of promoting public transport, green mobility solutions, and stricter emission norms for industrial zones.

The correlations between different pollutants were also explored, especially focusing on BTEX compounds due to their volatile nature and potential health implications. The study found a strong correlation between toluene and xylene isomers, suggesting common sources like vehicular emissions. The benzene-to-toluene ratio was particularly insightful, pointing towards diverse pollution sources in the city.



A deeper analysis of the benzene-to-toluene ratio revealed insights into the "aging" of air masses. Toluene and benzene, after being emitted from a common source, have different lifetimes in the atmosphere. Toluene is about five times more reactive than benzene, making a high concentration ratio of benzene to toluene an indicator of "old" air masses. The surveyed areas in Belgrade were divided diagonally into two segments:

- The north-west and north-east regions, covering the old city center, parts of Palilula, Kalemegdan, and Dorćol, showed a relatively high ratio of benzene and toluene concentrations. This indicated the influence of emissions from industrial-petrochemical plants like the Pancevo Oil Refinery and HIP "Petrochemistry" in the north-eastern part. Additionally, the retention of "old" air in narrow canyon-type streets in the north-western part and the inflow of "old" air masses from Obrenovac in the south-western part were observed.
- The southern region, covering areas like Vračar (Slavija), parts of Palilula, Takovska Street, and Zvezdara, exhibited a relatively low ratio of benzene and toluene concentrations, pointing towards the dominant influence of traffic emissions.

In conclusion, the integration of various models and methods provided a holistic view of the air quality dynamics in Serbia, especially in urban hubs like Belgrade. The insights derived from this study are pivotal for future environmental strategies and interventions in the region.

## CONCLUSION

The comprehensive study of air quality in Belgrade underscores the pressing challenges posed by local anthropogenic emissions. These emissions, intensified by population growth, an increase in motor vehicles, outdated technologies in the economic sector, and inadequate investments in the energy sector, have led to an atmosphere rife with pollutants, some of which are toxic, mutagenic, and carcinogenic. Predominant sources of these pollutants include energy sources like heating plants, thermal power plants, and individual chimneys, as well as traffic, industrial facilities, and small to medium production processes.

By employing a multifaceted approach, integrating traditional atmospheric dispersion models with advanced machine learning techniques, the study provided a holistic understanding of air pollution dynamics in the city. However, discrepancies between modeled and actual measurements emphasize the need for continuous methodological refinement and expansion of the monitoring system for better coverage and representativeness.

Air circulation, influenced by Belgrade's complex topographic and meteorological conditions, can lead to long-term retention or accumulation of pollutants in specific locations, causing significant disparities in population exposure even in spatially proximate areas. The study, as highlighted by Stojić A., revealed an increasing concentration of benzene, indicating the presence of volatile organic compounds and underscoring the need to monitor a broader spectrum of pollutants. While EU countries measure concentrations of up to 40 gases and various constituents of suspended particles, Serbia's assessment remains limited, emphasizing the need for a more comprehensive approach.

The City of Belgrade, recognizing the gravity of the situation, has adopted measures for the period 2021-2031, as outlined in the Air Quality Plan, to mitigate air pollution. These measures, combined with the potential benefits of alternatives like biodiesel, which offers economic advantages and reduced harmful emissions, point towards a path of sustainable urban development.

In conclusion, the integration of diverse methods and the insights derived from them emphasize the importance of a comprehensive approach to air quality monitoring. The findings serve as a clarion call for informed policy-making, targeted interventions, and the adoption of sustainable practices to safeguard the health of the city's residents and the environment.

## REFERENCES

- [1] [https://www.begrad.rs/images/data/7a0a3b18c076a6bfb21688ca7d314015\\_4302538578.pdf](https://www.begrad.rs/images/data/7a0a3b18c076a6bfb21688ca7d314015_4302538578.pdf)
- [2] <https://www.ready.noaa.gov/gdas1.php>
- [3] Lundberg S., Erion G et. Al, From local explanations to global understanding with explainable AI for trees (2020.) <https://doi.org/10.1038/s42256-019-0138-9>
- [4] Stojić A., Stanišić Stojić S, The innovative concept of three-dimensional hybrid receptor modeling, (2017.), <https://doi.org/10.1016/j.atmosenv.2017.06.009>
- [5] <http://www.sepa.gov.rs/>
- [6] <http://bpm.ipb.ac.rs/>
- [7] Gierałowski J, Żebrowski J. J., and Baranowski R., Multiscale multifractal analysis of heart rate variability recordings with a large number of occurrences of arrhythmia (2012.) <https://doi.org/10.1103/PhysRevE.85.021915>



## **ANALYTICAL MODELING OF SPATIAL DISTRIBUTION AIR POLLUTANTS FROM STATIONARY POINT SOURCES OF POLLUTION**

**Jelena Lamovec<sup>1</sup>, Stevo K. Jaćimovski<sup>1</sup>, Dušan I. Ilić<sup>2</sup>, Jovan P. Šetrajčić<sup>3</sup>**

<sup>1</sup>University of Criminal Investigation and Police Studies, Zemun – Belgrade, Serbia

<sup>2</sup>University of Novi Sad, Faculty of Technical Sciences, Novi Sad, Vojvodina - Serbia;

<sup>3</sup>Academy of Sciences and Arts of the Republic of Srpska, Banja Luka, Republic of  
Srpska – Bosnia and Herzegovina;  
e-mail: [jovan.setrajcic@gmail.com](mailto:jovan.setrajcic@gmail.com)

**Abstract:** Modeling the process of air pollutant dispersion is an important engineering tool in the research and prevention of the negative impact of pollution on the natural environment. In this paper, the analytical solution of the transport two-dimensional gradient equation of turbulent diffusion in the stationary mode of source operation is presented. The derived equations represent the dependence of diffusion coefficients and wind speed as a complex function of the distance from the ground surface. This model enables accurate prediction of the concentration level of emitted pollutants from the source and further downwind, under stable atmospheric conditions. The obtained results are compared with the same results obtained using the Gaussian dispersion model.

**Key words:** analytical model, pollutant dispersion, turbulent diffusion, point source of pollution.

### **1. INTRODUCTION**

The interest in dealing with the problem of pollution is constantly growing, especially when it comes to the safety of people directly or through the pollution of their environment. Problems of environmental pollution after more and more frequent occurrences of natural disasters or serious accidents during the transport of radio nucleotides or dangerous biological and chemical agents are very current [1].

Pollutant concentration measurements provide important quantitative information about the state of air quality at specific locations at a specific time. They cannot point to the reasons that led to problems with air quality, but with a good prognostic picture, they can predict the spatial spread of pollution and thus prevent catastrophic negative consequences.

We have been engaged in research in this area for several years [2,3] and this paper presents an analysis of a more complex model of the turbulent diffusion equation, when the diffusion coefficients and wind speed change with height according to a power law. The expression for the normalized concentration was found analytically, by solving the two-dimensional equation of turbulent diffusion.

The physics of particle transport or dispersion is a complex field that includes and accurately describes the distribution of the concentration of pollutant particles due to the process of transport and turbulent diffusion that dictate the dispersion of air masses and the pollutants that have entered them. It represents the basis for modeling the process of spatial distribution of pollutants.

Modeling the distribution of air pollution represents a complete deterministic description of the problem of the spread of air pollution, including the analysis of cause-and-effect relationships between various parameters (the number and distribution of pollutant emission sources, the topography of the terrain around the source, meteorological conditions such as the direction and speed of the wind, the stability of the atmosphere and temperature gradients, physic-chemical changes of pollutants, etc.), as well as some guidelines on the application of measures to mitigate the consequences of pollution [2].

We have been engaged in research in this area for several years [3,4] and this paper presents an analysis of a more complex model of the turbulent diffusion equation, when the diffusion coefficients and wind speed change with height according to a power law. The expression for the normalized concentration was found analytically, by solving the two-dimensional equation of turbulent diffusion.

## 2. MODELING OF THE AIR POLLUTION PROCESS

The dispersion of pollutants in the air is described by a partial differential, known as the diffusion equation [5]:

$$\frac{\partial C}{\partial t} + v \frac{\partial C}{\partial x} + u \frac{\partial C}{\partial y} + w \frac{\partial C}{\partial z} = \frac{\partial}{\partial x} k_x \frac{\partial C}{\partial x} + \frac{\partial}{\partial y} k_y \frac{\partial C}{\partial y} + \frac{\partial}{\partial z} k_z \frac{\partial C}{\partial z} - \vartheta C. \quad (1)$$

where  $v, u, w$  are the wind speeds in the direction of the respective axes,  $k_x, k_y, k_z$  are the diffusion coefficients along those axes, and  $\vartheta$  is the transformation coefficient (chemical change) of the admixture. The initial set conditions are that the flow is stationary ( $\frac{\partial C}{\partial t} = 0$ ), that the wind is directed along the  $y$ -axis (so  $v = 0$ ), and the  $z$ -axis is vertical, so the speed  $w$  can be ignored ( $w \approx 0$ ) for lighter pollutant particles, so in that case the diffusion equation is simpler:

$$Q u(z) \frac{\partial C(y,z)}{\partial y} = \frac{\partial}{\partial z} \left[ K(y,z) \frac{\partial C(y,z)}{\partial z} \right], \quad (2)$$

where is marked:  $\frac{1}{Q} \frac{\partial K(y,z)}{\partial z} = \frac{\partial k_z}{\partial z}$ ,  $K(y,z) \frac{\partial^2 C(y,z)}{\partial z^2} = -\vartheta C$ ,  $Q$  is the power of the source, i.e. the mass of emitted particles per unit of time, and  $K(y,z)$  represents the concentration tensor with boundary conditions (shown in Fig. 1):

$$\begin{aligned} -K(y,z) \frac{\partial C(y,z)}{\partial z} &= 0, \quad \text{for } z \rightarrow 0; & (i) \\ -K(y,z) \frac{\partial C(y,z)}{\partial z} &= 0, \quad \text{for } z \rightarrow h; & (ii) \\ u(z)C(0,z) &= Q\delta(z - H_S). & (iii) \end{aligned} \quad (3)$$

Here are:  $\delta$  – Dirac's delta function,  $H_S$  – the height of the pollutant source, and  $h$  – the height of the boundary layer of the atmosphere.

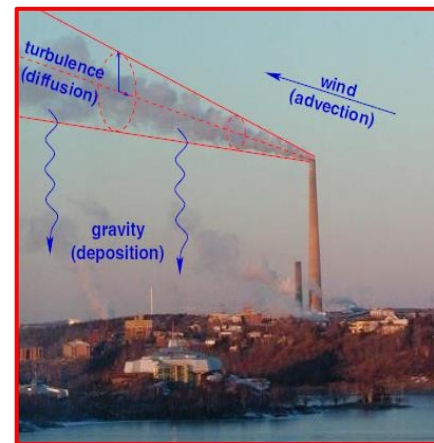
One of the most commonly used particle dispersion models is the Gaussian model for particle emission from continuous sources [7]. Because of its simplicity, it is accepted as a standard in all industrialized countries. The Gaussian model was developed assuming that the wind speed as well as the turbulent diffusion coefficients are constant, and the concentration is expressed as:

$$\frac{C}{Q} = \frac{1}{\sqrt{2\pi} \sigma_z u} \left[ e^{-(z-H)^2/2\sigma_z^2} + e^{-(z+H)^2/2\sigma_z^2} \right]. \quad (4)$$

where  $H$  is the effective height above the ground,  $u$  is the constant wind speed, and  $\sigma_y$  and  $\sigma_z$  represent the standard deviations of the  $C$  concentration distribution along the  $y$  and  $z$  directions, respectively.

## 3. ANALYTICAL SOLUTION OF THE TURBULENT DIFFUSION EQUATION

In a real situation with turbulent transport of particles, diffusion coefficients and wind speed are not constant, but change with height, approximately according to a power law. To calculate the ground concentration of admixture, it is necessary to determine the dependence of the diffusion coefficient  $k_z$  on height, at sufficiently high heights. It is usually taken that  $k_z$  depend linearly on  $z$  (in the ground layer) for  $z \leq h$  and remains unchanged for  $z > h$ . In the immediate vicinity of the Earth's surface, the diffusion coefficient  $k_z$  can be assumed to be approximately equal to the molecular diffusion coefficient. In [8] it was shown



**Fig. 1.** Graphic representation of advective turbulent diffusion of air pollutants (from [6])

that the speed of propagation and the coefficient of turbulent diffusion change with the distance from the ground according to the following law:

$$\begin{aligned} u &= u(z_r)z^m; & k_z &= k(z_r)z^n; \\ u &= a z^m; & k_z &= b z^n, \end{aligned} \quad (5)$$

where the coefficients  $m$  and  $n$  are determined according to the vertical wind speed profile. With the adopted assumptions, equation (3) can be written as:

$$\frac{\partial C(y,z)}{\partial y} = \frac{b}{a} z^{-m} \frac{\partial}{\partial z} \left( z^n \frac{\partial C(y,z)}{\partial z} \right). \quad (6)$$

This equation can be solved using the Fourier method of separation of variables [9]:

$$C(y, z) = Y(y)Z(z), \quad (7)$$

thus forming the following two equations:

$$\frac{dY(y)}{dy} + \lambda^2 Y(y) = 0; \quad (8a)$$

$$\frac{d}{dz} \left( z^n \frac{dZ(z)}{dz} \right) + \lambda^2 \frac{a}{b} z^m Z(z) = 0. \quad (8b)$$

The solution of equation (8a) has an exponential form:

$$Y(y) = B_0 e^{-\lambda^2 y}, \quad (9)$$

where  $\lambda$  and  $B_0$  are constants determined from the initial conditions.

Equation (8b) is solved by introducing a new replacement [10]:

$$Z(z) = z^{-\frac{1-n}{2}} G \left( z^{\frac{m-n+2}{2}} \right), \quad (10)$$

where  $G$  is the auxiliary function. Substituting in (9) into expression (10) follows:

$$Z(z) = z^{\frac{1-n}{2}} \left[ B_1 J_\nu \left( \alpha z^{\frac{m-n+2}{2}} \right) + B_2 J_{-\nu} \left( \alpha z^{\frac{m-n+2}{2}} \right) \right]. \quad (11)$$

Here,  $J_\nu$  and  $J_{-\nu}$  are Bessel functions of the first order, and  $B_1$  and  $B_2$  are constants determined from the boundary conditions. Tags are also introduced:

$$\alpha^2 = \frac{4}{m-n+2} \frac{a}{b} \lambda^2; \quad \nu = \frac{1-n}{m-n+2}. \quad (12)$$

By using conditions (i) and (ii) from expression (3), orthogonal eigen-functions [11,12] are obtained in the form:

$$Z_\mu(z) = z^{\frac{1-n}{2}} J_{-\nu} \left( \alpha_\mu z^{\frac{m-n+2}{2}} \right); \quad \mu = 1, 2, 3, \dots \quad (13)$$

The values for the coefficients  $\alpha_\mu$  are obtained as the roots of the equation:

$J_{-\nu+1} \left( \alpha h^{\frac{m-n+2}{2}} \right) = 0$ , so the expression for particle concentration (7) becomes:

$$C(y, z) = A_0 + z^{\frac{1-n}{2}} \sum_{\mu=1}^{\infty} A_\mu J_{-\nu} \left( \alpha_\mu z^{\frac{m-n+2}{2}} \right) e^{-\frac{b(m-n+2)^2 \alpha_\mu^2}{a} y}. \quad (14)$$

The unknown coefficients  $A_0$  and  $A_\mu$  are determined from condition (iii) of expression (3) and the fact that the eigen-functions  $Z_\mu$  are orthogonal. The final expression for particle concentration [11] has the form:

$$C(y, z) = Q \left[ \frac{m+1}{ah^{m+1}} + \frac{m-n+2}{ah^{m-n+2}} (zH_S)^{\frac{1-n}{2}} \sum_{\mu=1}^{\infty} \frac{J_{-\nu} \left( \gamma_\mu \left( \frac{z}{h} \right)^{\frac{m-n+2}{2}} \right) J_{-\nu} \left( \gamma_\mu \left( \frac{H_S}{h} \right)^{\frac{m-n+2}{2}} \right)}{J_{-\nu}^2(\gamma_\mu)} \right] e^{-\frac{b(m-n+2)^2 \alpha_\mu^2}{a} y};$$

$$\gamma_\mu = \alpha_\mu h^{\frac{m-n+2}{2}}; \quad \mu = 1, 2, 3, \dots \quad (15)$$

Moving from the sum to the integral in the limits from 0 to  $\infty$ , the previous expression can be transformed into:

– for the case when the height of the inversion layer of the atmosphere is  $h \rightarrow \infty$ :

$$C(y, z) = Q \frac{(zH_S)^{\frac{1-n}{2}}}{b(m-n+2)y} J_{-\nu} \left( \frac{2a(zH_S)^{\frac{m-n+2}{2}}}{(m-n+2)^2 y} \right) e^{-\frac{a(z^{m-n+2} + H_S^{m-n+2})}{b(m-n+2)^2 y}}; \quad (16)$$

– when the emission source is at a low altitude, i.e. at the ground,  $H_S \rightarrow 0$ , then the following applies:

$$C(y, z) = Q \frac{m-n+2}{a \Gamma\left(\frac{m+1}{m-n+2}\right)} \left[ \frac{a}{(m-n+2)^2 y} \right]^{\frac{m+1}{m-n+2}} e^{-\frac{az^{m-n+2}}{b(m-n+2)^2 y}}, \quad (17)$$

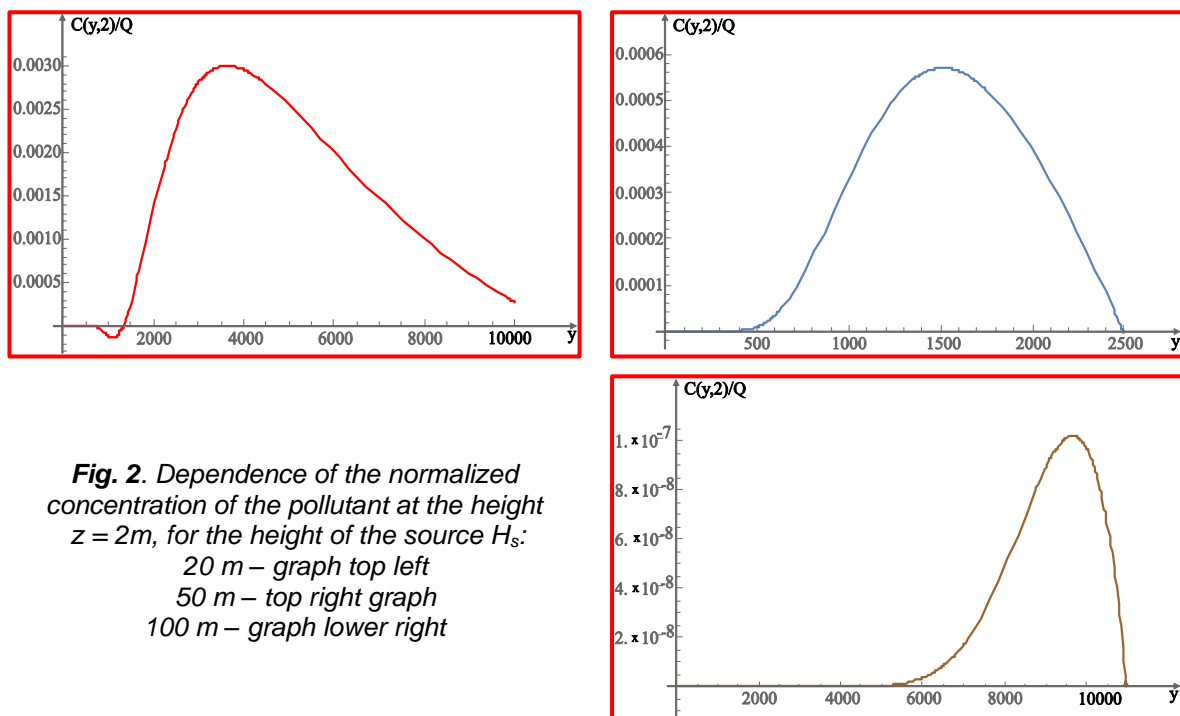
where  $\Gamma\left(\frac{m+1}{m-n+2}\right)$  is the gamma function. In the case when the exponents are  $m = n = 0$  and by introducing the substitution:  $\sigma_z^2 = \frac{2k_z y}{u}$ , equations (20) and (21) change to equation (4), which represents the Gaussian solution of the dispersion problem [13].

By using literature data (eg. from [14], which are shown in Tab. 1), the results of applying the analytical solution of equation (7), i.e. expressions (16) and (17), were obtained, which are shown graphically in Figs. 2–8.

**Table 1.** Values of parameters necessary for obtaining analytical solutions

Parameter	$m$	$n$	$a$ [m/s]	$b$ [m <sup>2</sup> /s]	$h$ [m]	$H_S$ [m]
Value	0,29	0,45	1,72	3,66	150	20; 50; 100

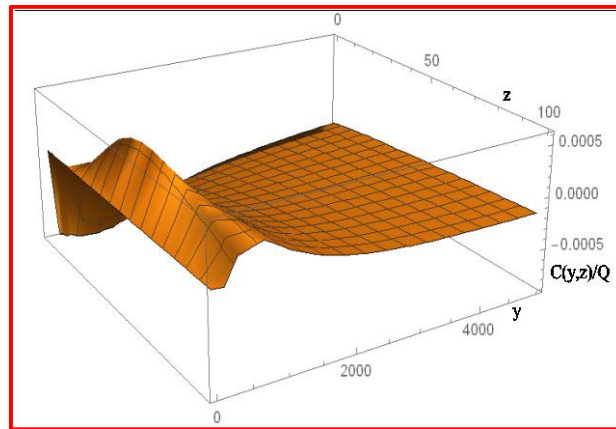
The dependence of the normalized concentration of pollutant particles,  $C/Q$  (the ratio of the concentration of particles to the emission power of the source, which are expressed in units of s/m<sup>3</sup>) as a function of  $y$  [m] - horizontal distance from the source is shown in the graphs on Figs. 2 - 8, but firstly measured at the height  $z = 2$ , 10 and 20 m, on the height of the source  $H_S$  when the boundary layer of the atmosphere tends to infinity ( $h \rightarrow \infty$ ), is shown in the graphs on Fig. 2.



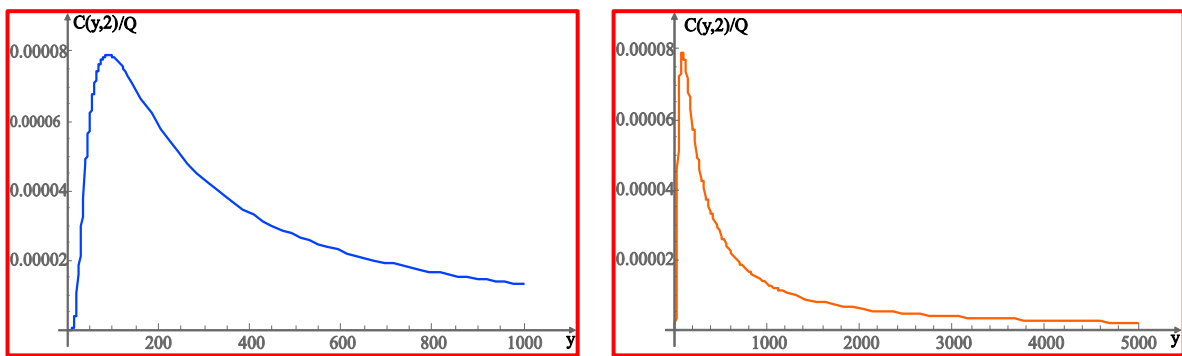
**Fig. 2.** Dependence of the normalized concentration of the pollutant at the height  $z = 2$  m, for the height of the source  $H_S$ :  
 20 m – graph top left  
 50 m – top right graph  
 100 m – graph lower right

The three-dimensional profile of the distribution of the normalized concentration of pollutant particles at the height  $z = 2$  m at the height of the source  $H_S = 50$  m is shown graphically in Fig. 3, and the dependence of the normalized concentration of pollutant particles,  $C/Q$  for a source that is located close to the ground surface ( $H_S \rightarrow 0$ ), measured at different heights is shown by the graphs in Fig. 4.

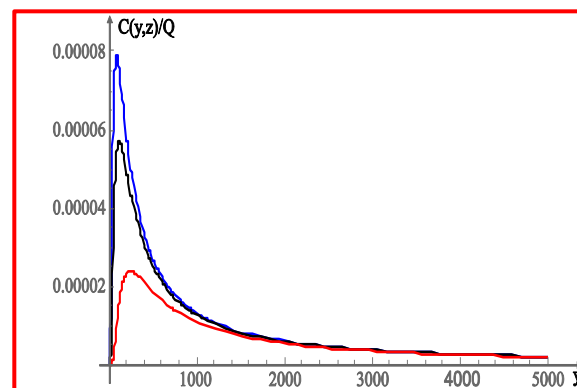
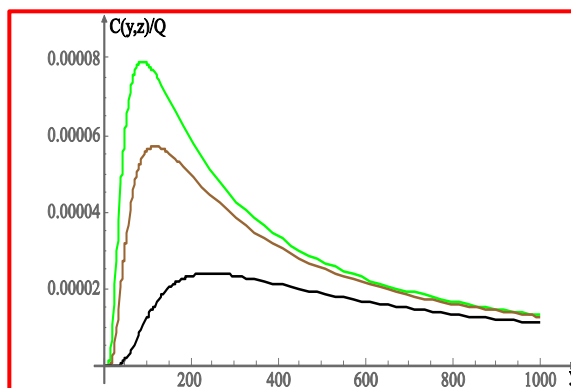
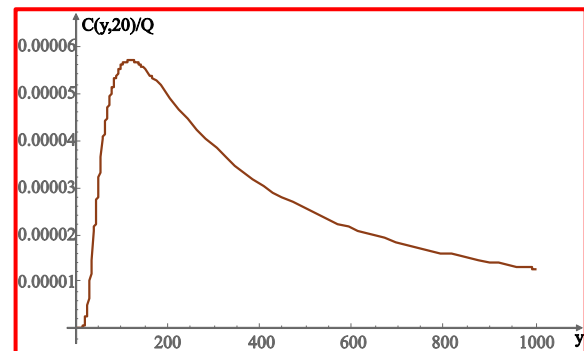
The dependence of the normalized concentration of the pollutant on the height  $z$ , for distances of 1.000 m and 5.000 m from the source, is shown by graphs in Fig. 5. The highest concentration of the pollutant is registered for measurements at a height of 2 m, which is significant for the safety of the human population, and concentrations up to 1.000 m of pollutant sources can be considered significant.



**Fig. 3.** 3D representation of the normalized concentration of the pollutant at the height  $z = 2$  m, for the height of the source  $H_s = 50$  m



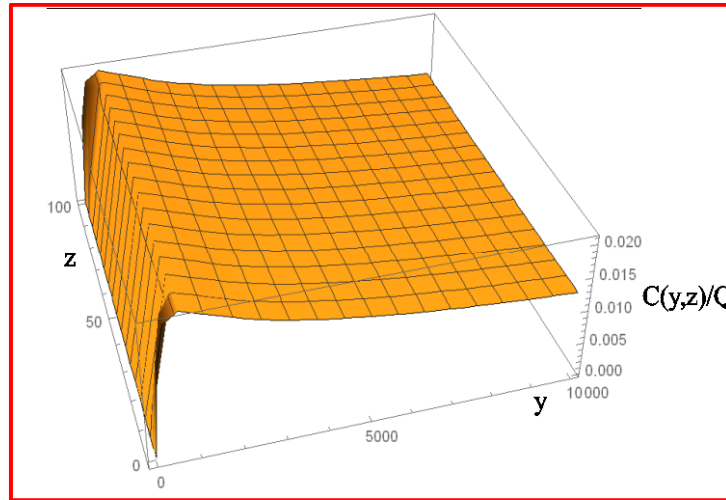
**Fig. 4.** Dependence of the normalized concentration of the pollutant on the height  $z$ :  
 2 m – graph on the top left  
 10 m – top right graph  
 20 m – graph lower right





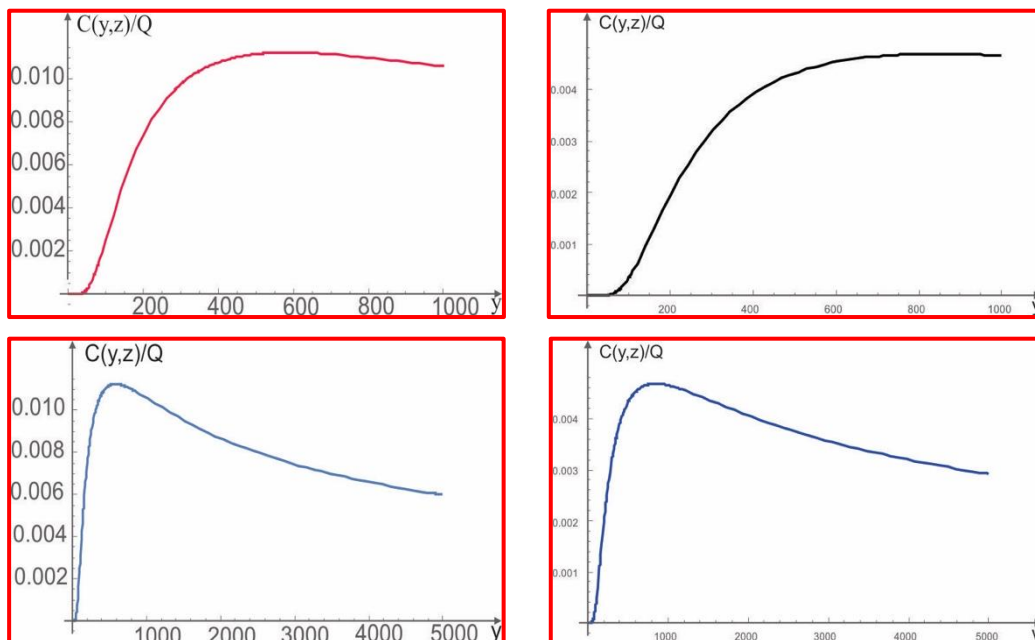
**Fig. 5.** Comparative view of normalized pollutant concentration at heights of:  $z = 2$  m (green curve),  $z = 10$  m (brown) and  $z = 20$  m (black curve) at a distance of up to 1 km (left)  $z = 2$  m (blue curve),  $z = 10$  m (black) and  $z = 20$  m (red curve) at a distance of up to 5 km (right)

The three-dimensional profile of the distribution of the normalized concentration of pollutant particles at a height of  $z = 2$  m is shown graphically in Figure 6.



**Fig. 6.** 3D presentation of the change in the normalized concentration of the pollutant with the distance from the source, at  $z = 2$  m

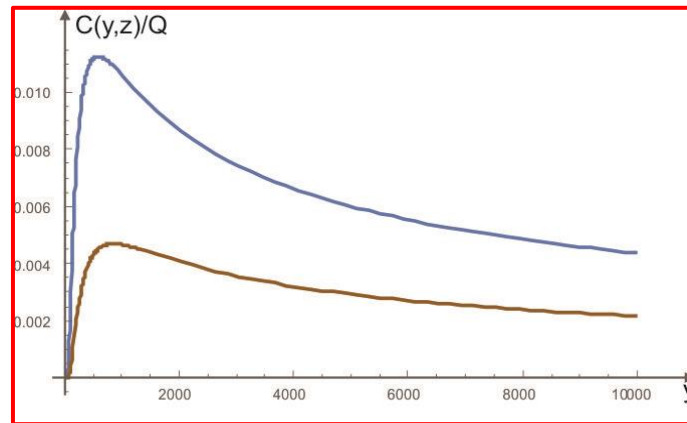
A graphical representation of the application of equation (6), which represents the Gaussian solution for particle dispersion ( $m = 0$ ,  $n = 0$ ), to the same experimental data (tab. 1), under the conditions  $h \rightarrow \infty$  and  $H_s \rightarrow 0$ , is given in the Fig.7. Changes in concentration at a height of  $z = 2$  m and at distances up to 1 km and 5 km from the source are shown.



**Fig. 7.** Normalized concentration distribution at  $z = 2$  m, according to the Gaussian model, for distances from the source of 1 km and 5 km. The graphics on the left side apply under the condition  $h \rightarrow \infty$ , and on the right side under the condition  $H_s \rightarrow 0$ .

A comparative representation of the distribution of the normalized concentration of particles at a height of  $z = 2$  m and distances up to 10 km from the source, under the conditions when

the inversion layer of the atmosphere  $h \rightarrow \infty$  and when the height of the source  $H_S \rightarrow 0$ , is shown graphically in Fig. 8.



**Fig. 8.** Normalized concentration distribution at  $z = 2$  m, according to the Gaussian model. The blue line corresponds to the condition when  $h \rightarrow \infty$ , the brown line to the case  $H_S \rightarrow 0$ .

It is noticeable that the normalized pollutant concentration has higher values when the boundary layer of the atmosphere satisfies the condition  $h \rightarrow \infty$ , than the case when the pollution sources are at low altitudes  $H_S \rightarrow 0$ .

#### 4. CONCLUSION

The paper analyzed a more complex model of the turbulent diffusion equation, when the diffusion coefficients and wind speed change with height according to a power law. The expression for the normalized concentration was found analytically, by solving the two-dimensional differential equation of turbulent diffusion.

From the results presented, it can be seen that the character of the concentration change with the distance  $y$  depends significantly on the  $z$  value. On the Earth's surface, at some distance  $y_{\max}$  from the source, the maximum normalized concentration  $C_{\max}(y, 0)/Q$  is observed, and with increasing  $z$ , the maximum  $C_{\max}(y, 0)/Q$  moves towards the source. At the height level of the admixture source  $y = H_S$ , the concentration decreases monotonically with increasing  $y$ . At higher levels, when  $z$  increases again, the maximum  $\frac{C_{\max 1}(y, 0)}{Q}$  is again observed and now at some distance from the source. Observing the vertical profile, it can be seen that for closer distances to the source, the maximum concentration is more pronounced, and that as the distance from the source increases, it lowers and moves to the area of greater distances (practically in the direction of the wind).

The most important results of this analysis are that the analytical solution of the turbulent diffusion equation can be derived, and that by introducing the dependence of the wind speed and the diffusion coefficient on the distance ( $z$ ) according to the power law  $u = a z^m; k_z = b z^n$ , the expression for the normalized concentration of pollutant particles is reduced to a Gaussian distribution in the case where  $m = n = 0$ .

Future research should go in the direction of model analysis for specific cases of air pollutants (e.g. TE Kostolac, ...), which would include a comparison of the measured values of a certain pollutant and the values given by the model shown.

#### ACKNOWLEDGEMENT

The research presented in this paper was financially supported by the Ministry of Scientific and Technological Development, Higher Education and Information Society of the Republic of Srpska (Projects No. 19.032/961-36/19 and 19.032/961-42/19)) and by the Ministry of

Science, Technological Development and Innovation through Project no. 451-03-47/2023-01/200156 "Innovative scientific and artistic research from the FTS (activity) domain".

## REFERENCES

- [1] Builtjes, P., Paine, R., The problem-Air pollution, In: Air Quality Modeling – Theories, Methodologies, Computational Techniques, and Available Databases and Software, Vol.4 – Advances and Updated (P. Zannetti, Ed.), Ch. 1, EnviroComp Institute and Air & Waste Management Association, 2010.  
<http://www.computationalengineeringmathematics.com/Chapter1-AQM4.pdf>.
- [2] Nikezić, D.P., et al. Modeling Air Concentration of Fly Ash in Belgrade Emitted from Thermal Power Plants TNTA and TNTB, Process Saf. Environ. Vol. 106, pp. 274-283, 2017.
- [3] Jaćimovski, S.K., Lamovec, J., Šetrajić, J.P., Spatial-temporal distribution of air pollution from a point source - quasi 1D model, Zaštita materijala Vol. 61-2, pp. 104-109, 2020. doi: [10.5937/zasmat2002104J](https://doi.org/10.5937/zasmat2002104J).
- [4] Ilijazi, V., Jaćimovski, S.K., Milić, N., Popović, B., Software Supported Visualization of Mathematical Spatial-Time Distribution Models of Air-Pollutant Emissions, J. Sci. Ind. Res. India Vol. 80, pp. 915-923, 2021.  
<https://nopr.niscpr.res.in/handle/123456789/58226> .
- [5] Crank, J., The Mathematics of Diffusion, Clarendon Press, Oxford 1975. ISBN: 9780198534112.
- [6] Stockie, J.M., The Mathematics of Atmospheric Dispersion Modeling, SIAM Review, Vol. 53-2, pp. 349-372, 2011. doi: [10.1137/10080991X](https://doi.org/10.1137/10080991X) .
- [7] Seinfeld, J.H., Pandis, S.N., Atmospheric Chemistry and Physics: From Air Pollution to Climate Change, 3rd Ed., Wiley, New Jersey, 2016. ISBN: 9781118947401.
- [8] Sutton, O.G., Micrometeorology, McGraw-Hill Book Company, New York, 1953. doi: [10.1002/qj.49707934125](https://doi.org/10.1002/qj.49707934125).
- [9] Zauderer, E., Partial Differential Equations of Applied Mathematics, Wiley, New Jersey, 2006. ISBN: 9780471960733.
- [10] Whittaker E.T., Watson G.N., A Course of Modern Analysis, 4<sup>th</sup> eEd., University Press, Cambridge 2013. doi: [10.1017/CBO9780511608759](https://doi.org/10.1017/CBO9780511608759).
- [11] Abramowitz M., Stegun I.A., Handbook of Mathematical Functions, National Bureau of Standards, Applied Mathematics Series - 55, 1962.
- [12] Gradshteyn I.S., Ryzhik I.M., Table of Integrals, Series and Products, Elsevier Academic Press, New York, 2007.
- [13] Huang, C.H., A Theory of Dispersion in Turbulent Shear Flow, Atmos. Environ., Vol.13, pp. 453-363, 1979.
- [14] Kumar P., Sharan M., An Analytical Model for Dispersion of Pollutants from a Continuous Source in the Atmospheric Boundary Layer, Proceedings: Mathematical, Physical and Engineering Sciences, Vol. 466-2114, pp. 383-406, 2010, doi:[10.1098/rspa.2009.0394](https://doi.org/10.1098/rspa.2009.0394).



## THE IMPORTANCE OF USING AIR FILTER IN THE PROCESS OF STEAM STERILIZATION OF MEDICAL WASTE

Jelena Kiurski-Milošević<sup>1</sup>, Aleksandra Šučurović<sup>1</sup>, Nataša Zec<sup>1</sup>

<sup>1</sup>Technical College of Applied Sciences in Zrenjanin, Serbia

e-mail:[jelena.kiurski@vts-zr.edu.rs](mailto:jelena.kiurski@vts-zr.edu.rs)

**Abstract:**As any treatment of medical waste has a certain negative impact on air quality, purification of exhaust gases is very important. The aim of the work is to show the importance of the air purification unit in the steam sterilization process of medical waste, without which there would be increased concentrations of pollutants in the air. These are mostly emissions of organic compounds and odors: methyl sulfhydryl, dimethyl sulfide, methyl disulfide, hydrogen sulfide and other volatile organic compounds. Thanks to the use of filters in autoclaves, emissions of exhaust gases have been reduced to values below the permitted legal limits. So, the possibility of environmental pollution as well as a harmful effect on human health were prevented. In the paper is presented integrated air filter unit from Logmedtechnology autoclave.

**Key words:**medical waste, steam sterilization, air filter, emissions

### INTRODUCTION

Medical waste is waste generated from facilities where health care for people or animals is performed and/or from other places where health and other services are provided (from diagnostics, experimental work, laboratories, cleaning, maintenance and disinfection of premises and equipment), and it includes non-hazardous and hazardous medical waste[1].

Management of medical waste is a major problem at the global level due to its significant health and environmental hazards. The basic principles of managing this type of waste are reducing its quantity, then sorting waste into basic categories at the point of generation, proper packaging, labeling and disposal, separating secondary raw materials from waste, recycling. The biggest problem occurs at the first step, with proper classification and sorting at the place of origin. Proper sorting leads to safer ways of waste treatment.

Steam sterilization process is done in autoclave devices in which waste is inactivated at high temperature and pressure by means of steam. Temperature and pressure are the main parameters that are controlled to make the sterilization process successful. Excessive temperatures lead to the emission of VOCs, which pose a problem with the quality of the exhaust air [2].

### Steam sterilization process in autoclaves

Autoclaves are devices in which is done steam sterilization process of medical waste. In order to make the waste more compact and to achieve better sterilization they also have a shredder inside them. They consist of sterilizer of solid and liquid medical waste, a drying unit and a steam generator. Medical waste, after being crushed and reduced in volume, is transferred from the shredder by a motorized screw conveyor and unloaded through a special door. The saturated steam for the sterilization container is created in a steam generator.

Medical waste for sterilization is delivered in single use bags or buckets, to the device through sliding door open. The door slides shut and the process is initiated by an electronic impulse. Weight waste is documented and recorded through an integrated measurement process. Conveyor belt discharges medical waste into the filling funnel. The entire filling block is spatially separated, in which is created a low pressure during the work process so that the

emission of pollutants is effectively prevented. Suction air is passed through a filter before being released into the outside air.

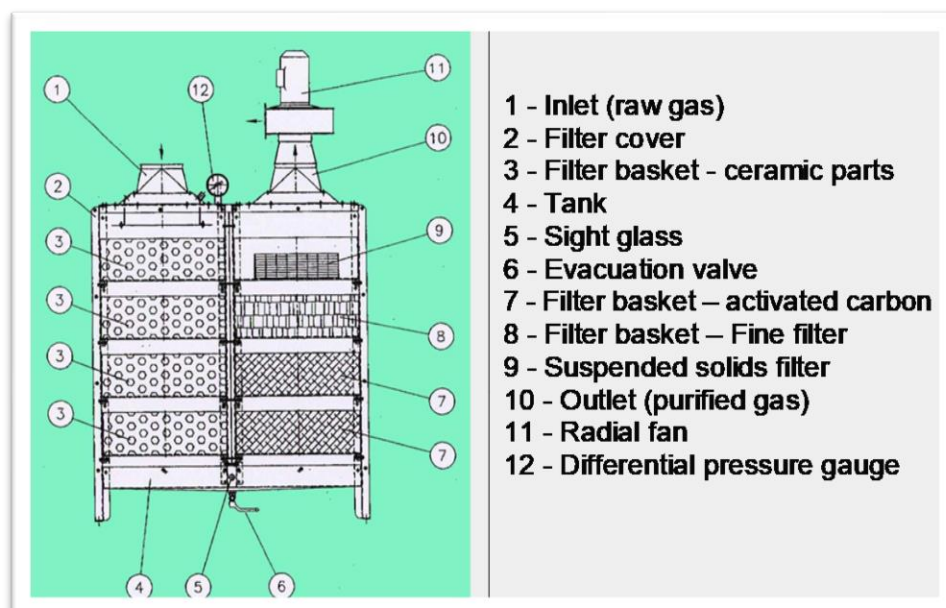
Autoclaves can be created with the shredder so that the mass in the device can be homogeneous. A suitable vacuum is applied to remove air bubbles and steam, so that the steam can penetrate deep into the internal quantities of the waste material before the sterilization process. Hot steam is sent to the sterilization section to achieve the ideal temperature and pressure conditions for sterilization.

After a sufficient time of exposure to sterilization, it stops, and the vacuum dries and cools the sterilized waste and extracts steam through a vacuum pump. Finally, air is introduced into the container by an air valve and atmospheric pressure is provided, and then the discharge port is automatically opened to discharge the sterilized medical waste by screw conveyor. The autoclave sterilizes at a temperature in the waste of 121 – 134 °C for 15-60 min with a pressure of 3-5 bar[3,4].

Shredded waste is deposited in a separate bin/container which is then taken to an incineration plant, or it can be submitted and disposed to the public communal company as non-hazardous waste[5]. In EU countries, the practice is to burn waste after sterilization in incinerators for industrial waste. Hossain et al. (2012) showed that, due to unexpected re-growth of bacteria in the sterilized waste, steam autoclave should not be considered as an alternative technology of incineration in clinical solid waste management. So this type of treatment can only be a pre-treatment of the medical waste [6].

#### **Air purification unit in Longmed technology autoclaves**

Air purification treatment from the autoclave consists of removing organic matter and particulate matter from the air stream. Particulate matter is created during the process of crushing medical waste, while organic matter is generated in the process of medical waste treatment at higher temperatures. The filters are made in such a way that they consist of filter cartridges that are changed after saturation and the appropriate number of cycles, according to the manufacturer's instructions. Logmed technology autoclaves have the air filter with: ceramic filter cartridge, activated charcoal air filter and fine filter. The first two filters reduce the organic matter in the exhaust air, and the fine filter reduces the particulate matter. On the Fig. 1 is presented its structure[7].



**Fig. 1.** Structure of the air filter unit[7]

Air filter cartridges with ceramic parts and activated carbon are removing all VOCs and any unpleasant odor from exhaust gas. So, they are treating the gas phase. Fine filter and suspended solids filter are removing all particulate matter or solid phase that is present in air inlet. Air filters must meet the criteria proposed by national and international legal acts.

## DISCUSSION

During the treatment of hazardous and non-hazardous waste in autoclave, certain emissions of gases and unpleasant odors may occur during the method of sterilization and grinding. The devices themselves are equipped with filters that prevent the emission of gases and particulate matter into the ambient air. The more complex is filter, the greater is its efficiency. Dengchao et al. (2017) determined the content of several volatile organic compounds in the gases of medical waste. Gases were detected and analyzed by gas chromatography. Their average concentration was: methyl sulfhydryl 0.037 mg/m<sup>3</sup>, dimethyl sulfide 0.046 mg/m<sup>3</sup>, methyl disulfide 0.904 mg/m<sup>3</sup> and hydrogen sulfide 0.204 mg/m<sup>3</sup>. After being treated with steam sterilization, the average removal rates of the listed compounds are methyl sulfhydryl 93%, dimethyl sulfide 92.6%, methyl disulfide 97.6%, and hydrogen sulfide 92.6%[8].

The results of the Farshad et al. (2014) study showed that the concentration of benzene in emissions of 30% of samples of autoclave with shredder were higher than the Iranian standard Threshold Limit Value (TLV), but the concentration of BTEX, toluene, xylene, and ethyl benzene were lower than the TLV[9].

Martinovic et al. (2020) monitor ambient pollution during infectious medical waste sterilization. They measured ambient pollution in working environment during infectious medical waste treatment in Clinic Center of Serbia. They showed that during sterilization process following concentrations were increased: hydrogen chloride, formaldehyde, phenol, acrolein, and dimethyl disulfide, as well as methyl and ethyl mercaptan[10].

Hadar et al. (1997) detected up to 30 mg/m<sup>3</sup> of total volatile organic compounds (TVOC) were measured in autoclave emissions from a typical hospital waste load including xylenes, ethyl benzene, toluene, carbon sulfide, acetone and to a lesser extent styrene. These compounds can be released when sterilized waste is unloaded into containers. They noted that after opening the autoclave, it takes up to 10 minutes or more for the vapors to disperse. Thus they recommended that in the absence of a local exhaust system, personnel leave the area for 10-15 minutes before dismantling the load, in order to avoid exposure to emissions from the autoclave[11]. Also, Dengchao et al. (2017) conclude that the areas with autoclaves is necessary to have air ventilation and to have appropriate air changes per hour[7]. According to the World Health Organization (WHO), acceptable TVOC concentration levels are considered to be lower than 0,3 mg/m<sup>3</sup>[12].

So, the main things with the steam sterilizing process are: air filter unit and its maintenance and appropriate air ventilation to avoid exceed emission levels of pollutants in air.

## CONCLUSION

Steam sterilizations process are present in almost every health related institution in our country according to the registry of permits from the Environmental Protection Agency in Serbia. Sterilization at the point of origin of medical waste eases its further transport to the treatment. That is why it is very important that this process is done according to all principles of best available techniques.

The main problem with autoclave for the environment and working place are air emissions. We see that many authors have been writing about emissions from steam process sterilization. So the main thing is to put right air filters in the autoclave and to maintain them and replace when it is recommended according to the manufacturer's instructions. Air filters for autoclaves have different structure but they all have the same purpose to eliminate pollutants from exhaust air. Logmed technology autoclaves have filters with different charging



like fine filter, activated carbon and ceramic filters. Filters with more cartridges have more efficacy of removing air pollutants from autoclave exhaust gases.

## REFERENCES

- [1] Law on Waste Management (Official Gazette of the Republic of Serbia 36/2009, 88/2010, 14/2016, 95/2018 and 35/2023).
- [2] Dengchao, J., Hongjun, T., Zhenbo, B., Yang, L., Content and Formation Cause of VOCs in Medical Waste Non- incineration Treatment Project, IOP Conf. Series: Earth and Environmental Science 113, 012005, 2018.
- [3] WHO, Safe Management of Waste from Health-Care Activities; World Health Organization, Geneva, Switzerland, 1999.
- [4] Rutala, W., Weber, D., Guideline for Disinfection and Sterilization in Healthcare Facilities (2008), Centers for Disease Control and Prevention, Guidance for evaluating medical waste treatment technology, Final report, US EPA, 1993.
- [5] WHO, Overview of technologies for the treatment of infectious and sharp waste from health care facilities, World Health Organization, Geneva, Switzerland, 2019.
- [6] Hossain, S., Balakrishnan, V., Rahman, N., Sarker, Z., Kadir, O., Treatment of clinical solid waste using a steam autoclave as a possible alternative technology to incineration. *Int J Environ Res Public Health*, Mar;9(3):pp. 855-67, 2012.
- [7] Traitement de déchets d'activités de soins à risques infectieux et stérilisation des liquides, TRAITEMENT DES DASRI LOGMED I 300 SMI INSTRUCTION, Industries des Technologies Nouvelles, Micro Environment.
- [8] Dengchao, J., Hongjun, T., Zhenbo, B., Yang, L., Biological removal effect for odor in medical waste steam treatment process, IOP Conference Series: Earth and Environmental Science 61, 012142, 2017.
- [9] Farshad, A., Gholami, H., Farzadkia, M., Mirkazemi, R., Kermani, M., The safety of non-incineration waste disposal devices in four hospitals of Tehran, *Int J Occup Environ Health*, 20(3): pp. 258–263, 2014.
- [10] Martinovic, B., Jelic, V., Rikalovic, M., Sljivic-Ivanovic, M., Radosavljevic, J., Kostic, A., Adzemovic, M., Comparison of air pollution in the working environment during in site treatment of infectious medical waste by convertor and autoclave sterilization, *Fresenius Environmental Bulletin*, Volume 29 – No. 04/2020, pp. 2160-2165, 2020.
- [11] Hadar, J., Tirosh, T., Grafstein, O., Korabelnikov, E.: Autoclave emissions – hazardous or not, *Journal of the American Biological Safety Association*, 2(3) pp. 44-51, 1997.
- [12] WHO, Air quality guidelines for Europe – Second Edition, World Health Organization, Geneva, Switzerland, 2000.





## THE DIAGNOSTICS OF ELASTIC ENERGY OF RELAXATION PROCESSES IN OXYGEN SATURATION TIME IN THE AERATED REFINERY WASTEWATER

Miladin V. Ševaljević<sup>1</sup>, Stojan N. Simić<sup>2</sup> Mirjana M. Ševaljević<sup>3</sup>

<sup>1</sup>Technical School, Zrenjanin, Serbia,

<sup>2</sup>Faculty of Mechanical Engineering, East Sarajevo, Bosnia and Hecegovina,

<sup>3</sup>University of Novi Sad, Technical Faculty "Mihajlo Pupin", Zrenjanin, Serbia

e-mail: [sevaljevic.mirjana@gmail.com](mailto:sevaljevic.mirjana@gmail.com)

**Abstract:** The aim of this work is to examine the effects of the aeration regimes on elastic potential energy of material involved in oxygen steady dissolution in contaminated aerated refinery wastewater, from its equilibrium states reached in pure water layer of double water film of gas/liquid contact surfaces. The method is based on the conservation law of oxygen mechanical energy, released in relaxation processes involved in oxygen steady dissolution in the examine regimes. It correspond to the departures of the energy consumption in oxygen molar introduction in equilibrium state via external source, from the critical pressure of gases involved in electric power maximal transfer efficiency in oxygen steady dissolution.

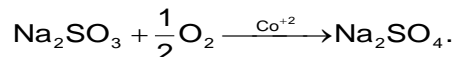
**Key words:** aeration treatments, oxygen steady dissolution, relaxation processes

### INTRODUCTION

The most important purification treatments of refinery wastewater used after primary coagulation and flocculation processes, needed to respond to environmental requirements for purified refinery wastewater are aeration treatments by fine membrane diffuser. The sustainable economic aeration process is based on the known parameters controlling the minimal energy losses in the relaxation processes, caused by the departures of the energy consumption per one equilibrium dissolved molecule (mole) from the critical pressure of gases collisional current involved in oxygen steady dissolution by maximal transfer efficiency.

### MATERIAL AND METHODS

The examined aeration treatments define the operational parameters (c-h-q) [1]: added oil content, *c* of 0, 5 and 10 gm<sup>-3</sup>, water column height, *h* of 1 m and 2 m at water volume 0.5 m<sup>3</sup> and 1 m<sup>3</sup>, and air flow, *q* of 2, 6 and 10 m<sup>3</sup>h<sup>-1</sup> in primary purified chemically *de*-oxygenated refinery wastewater by added Na<sub>2</sub>SO<sub>3</sub> and CoCl<sub>3</sub>·6H<sub>2</sub>O according to chemical equation:



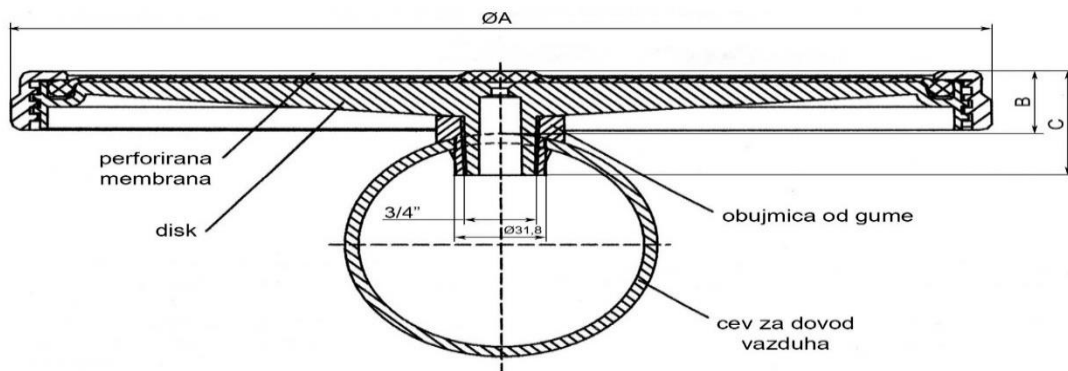
In the primary purified wastewater was added viscous waste motor oil SAE 15 W-40, with 132.0 mm<sup>2</sup> s<sup>-1</sup>. It contains 0.310 % Ca; 0.039 % Zn; 44.87 ppm Al; 13.42 ppm Fe; 4.11 ppm <sup>i</sup>Cu; 0.98ppm Cr. The physical properties of the obtained samples are mass density (992.8, 996.1 and 997.3) kg m<sup>-3</sup>, kinematic viscosity (8.1·10<sup>-7</sup>, 9.1·10<sup>-7</sup> and 9.9·10<sup>-7</sup>m<sup>2</sup> s<sup>-1</sup>) and the surface tension (0.0762, 0.0648 and 0.0573 N m<sup>-1</sup>).

Complete investigation of aeration processes in charge reactor made of polypropylene started by reading the temperature of gas, surrounding air and of water in the column (Fig. 1). Air flow is switched-on through membrane diffuser using the low pressure blower (Fig.2), when the first bubble appears at bubble pressure equal to the air over-pressure measured as the difference in front before the air distributor, and after the orifice plate.

The applied same air distributor for fine aeration-bubble diameter, consists membrane Gummi-Jaeger GmbH the fine perforated material of etilene-propien dimer, EPDM HD340 / 310 ( Fig. 2) After the opening of valve of air distributor in order to meet the demand of oxygen when the flow is stabilized, sampling of water from the column in equal time intervals starts ( $\Delta\tau = 60$  s) and the dissolved oxygen content is measured with HANNA instrument (Fig. 3.), until the same value is repeated in three time intervals of 1 min.



**Fig. 1.** Experimental installation for examination of aeration of refinery waste water [1]



**Fig. 2.** Air distributor as disc membrane diffuser [1]



**Fig. 3.** Determination of oxygen content in small aliquot of aerated water using HANNA instrument with polarography sensor [1]

Transport coefficient of oxygen equilibrium dissolution according to Henry law in pure water layer of double water film,  $k_L a$  is determined on the basis of oxygen mass conservation law in gas and liquid phase, as the product of its vertical velocity ( $k_L$ , m/s) and specific contact surface between gas phase and liquid volume ( $a$ ,  $m^2/m^3$ ) [1].

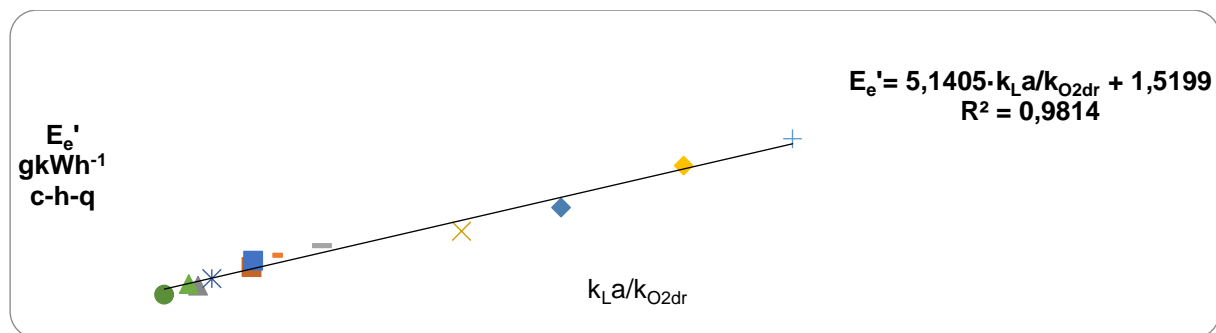
### Previous results

The data found for oxygen introduction rate constants are used in the determination of the energy efficiency of oxygen introduction,  $E_e'$  as the ratio of: (a) oxygen transport capacity,  $k_L a \cdot c^*$  defined as the product of oxygen transport coefficient and of equilibrium oxygen concentrations in pure water layer of double water film in gas/liquid contact surfaces,  $c^*$  defined to Henry law, (b) and the electric power consumed via external source,  $\Sigma P_i$  [1]:

$$E_e' = \frac{k_L a \cdot c^*}{\Sigma P_i}, \frac{g}{kWh} \quad (1)$$

Its reciprocal value defines the electric energy consumption in equilibrium introduction of one oxygen mole:

$$W = \frac{\Sigma P_i}{k_L a \cdot c^*}, \frac{kJ}{mole} \quad (2)$$



**Fig. 4.** Functional dependence fit the experimental data obtained for the examined aeration regimes: the real energy efficiency of oxygen transport,  $E_e'$ ,  $gkWh^{-1}$ , and the ratio between measured oxygen transport coefficients in liquid and gas phase  $(k_L a)/k_{O2dr}$  [2]

The slope,  $\tan$  of strong correlated linear functional dependence defines the ratio between  $E_e'$ ,  $gkWh^{-1}$  and  $x = k_L a / k_{O2dr}$  (Fig. 4).

$$\tan = \frac{\Delta E_e'}{\Delta(k_L a / k_{O2dr})} = 5.1405 g(O_2) kWh^{-1} \quad (3)$$

It determines:

(a) The energy efficiency of molar introduced oxygen proportional to the ratio between oxygen drift and oxygen introduction transport coefficient:

$$\Delta E_e'^{\theta} = \tan \cdot \frac{\Delta(k_L a / k_{dr})}{M_r(O_2)} = \frac{5,1405}{32} (k_L a / k_{dr}), mole(O_2) kWh^{-1} \quad (4)$$

(b) And its reciprocal value as the energy consumption in oxygen molar introduction, equal to water critical pressures:

$$W_{kLa=kdr}^{\theta} = \frac{32}{5,1405} 3,6 \cdot 10^6 = 22,41 MJmol^{-1} = p_{cr}(H_2O) \quad (5)$$

Where:

$$\tan = \frac{W^{\theta}}{(k_{dr} / k_L a)} = \frac{p_{cr}(H_2O)_{kLa=kdr}}{1} \quad (6)$$

It defines the energy consumption in oxygen molar introduction in aeration treatment as the part of water critical pressure proportional to the ratio between oxygen drift and introduction transport coefficients:

$$W^\theta = \frac{k_{dr}}{k_{La}} p_{cr}(H_2O)_{k_{La}=k_{dr}} \quad (7)$$

Maximal transfer efficiency of oxygen from Helmholtz planes in electric double layer at equal resistances to breakdown current at both sides of cascade formed bubble surfaces [3] enable coupled processes of hydrogen reversible recombination at critical pressure of gaseous products of adsorbed elements,  $p_{cr}$  at floated electrode surfaces at constant air flow [4]:

$$W_q^\theta = \varepsilon_r \cdot F \cdot (U_{PB} - E_{jon}(H)) + W_{\Delta U=0}^\theta \quad (7)$$

$$p_{cr}(AH_z) = W_{\Delta U=0}^\theta \quad (8)$$

The released kinetic energy defines its differences dependent on the operational parameters in the aeration regimes:

$$E_{kin} = p_{cr}(AH_z) - W_q^\theta \quad (9)$$

### Theoretical approach

The diagnostic method of elastic energy involved in relaxation processes due to the departures between Paschen breakdown voltage and hydrogen ionization potential are  $W_q^\theta$  is based on the conservation law of oxygen mechanical energy controlling oxygen steady dissolution where:

$$E_{kin in} + Ue_{in} = -Ue_{ex} \quad (10)$$

The substitution of Eq. (9) in Eq. (11) results at the presence of intermolecular forces in Helmholtz planes of electric double layer,  $\varepsilon$  and in ideal gas state at  $\varepsilon_0$ :

$$\frac{(p_{cr}(AH_z) - W_q^\theta)_G}{\varepsilon_0} = -\frac{Ue_{in} + Ue_{ex}}{\varepsilon} \quad (11)$$

The theoretical approach to the elastic potential energy,  $U_e$  is based on Gibbs adsorption isotherm that defines [3]:

- (a) the effect of surface concentrations of oxygen on the departures of surface tension of aerated water relating to pure water film

$$\Gamma = \frac{(c^* - c)}{A} = \frac{\Delta\sigma}{RT} \quad (12)$$

- (b) adsorption surface per one mole of a part of oxygen equilibrium dissolved after saturation time  $A^\theta$

$$A^\theta = \frac{A}{c^* - c} = \frac{RT}{\Delta\sigma} \quad (13)$$

- (c) and surface volume,  $V^\theta$  at average distance between two collisions defined on the basis of absolute temperature,  $T$  water viscosity,  $\eta$  and diffusion coefficient of oxygen in,  $D= 10^{-8} \text{ m}^2/\text{s}$  in ions pair with heavy metals:

$$V^\theta = A^\theta \cdot r_{\eta,D} \frac{m^3}{mol} \quad (14)$$

Where:

$$r_{\eta,D} = \frac{k_B T}{6\pi\eta D} \quad (15)$$

A load of air over pressure on surface volume of oxygen adsorbed at hydrophobic oxygen adsorption active centers in ideal gas state causes isochoric gas compression air input and isobaric extension at air exit.

$$(V^\theta \cdot dp)_{in} = -(p \cdot dV^\theta)_{ex} \quad (16)$$

It can be rearranged in the form of Hooke's law:

$$dp = p \frac{dV^\theta}{V^\theta} = p \frac{dl}{l_0} \quad (17)$$

It enables the determination of Young's modulus of elasticity, E:

$$E = \frac{dp}{\left(\frac{dV^\theta}{V^\theta}\right)} \quad (18)$$

on the basis of the experimental data for air over pressure equal to bubble pressure,  $dp = p_b$  and the relative deformation of molar surface volume of adsorbed oxygen:

$$\frac{dV^\theta}{V^\theta} = \frac{dn(O_2) \cdot V^\theta - V^\theta}{V^\theta} = \frac{((c^* - c_s)_{O_2} \cdot V_L) V^\theta - V_L}{V^\theta} = (c^* - c_s)_{O_2} \cdot V_L - 1 \quad (19)$$

Then the rearranged Eq. (17):

$$E = p = \frac{dp}{dV^\theta / V^\theta} = \frac{f \cdot V^\theta}{A^\theta \cdot dV^\theta} \quad (20)$$

Enables the determination of the elastic potential energy the hydrophobic adsorption active centers:

$$Ue = \int f \cdot dV^\theta = \frac{1}{2} k \cdot dV^{\theta 2} \quad (21)$$

Elastic force, f and coefficient of elasticity, k defines Young's modulus of elasticity:

$$f = \frac{dp}{A^\theta} = \frac{E \cdot A^\theta}{V^\theta} dV^\theta \quad (22)$$

$$k = \frac{f}{dV^\theta} = \frac{E \cdot A^\theta}{V^\theta} \quad (23)$$

Its substitution in Eq. (21) results in the form:

$$Ue = \frac{1}{2} \frac{E \cdot A^\theta}{V^\theta} \cdot dV^{\theta 2} \quad (24)$$

Where:

$$\frac{Ue}{A^\theta \cdot V_0^\theta} = \frac{1}{2} E \left(\frac{dV^\theta}{V_0^\theta}\right)^2 \quad (25)$$

Its rearrangement can be used in the diagnostic of elastic potential energy of surface active components:

$$E = \frac{2Ue}{A^\theta \cdot V_0^\theta} \cdot \frac{1}{\left(\frac{dV^\theta}{V_0^\theta}\right)^2} + E_0 \quad (26)$$

Where:

$$y = E \quad \text{and} \quad x = \frac{2Ue}{A^\theta \cdot V_0^\theta} \quad (27)$$

where the slope, tan experimental determined for strong correlated linear functional dependence

$$\tan = \frac{2Ue}{A^\theta \cdot V_0^\theta} \quad (28)$$

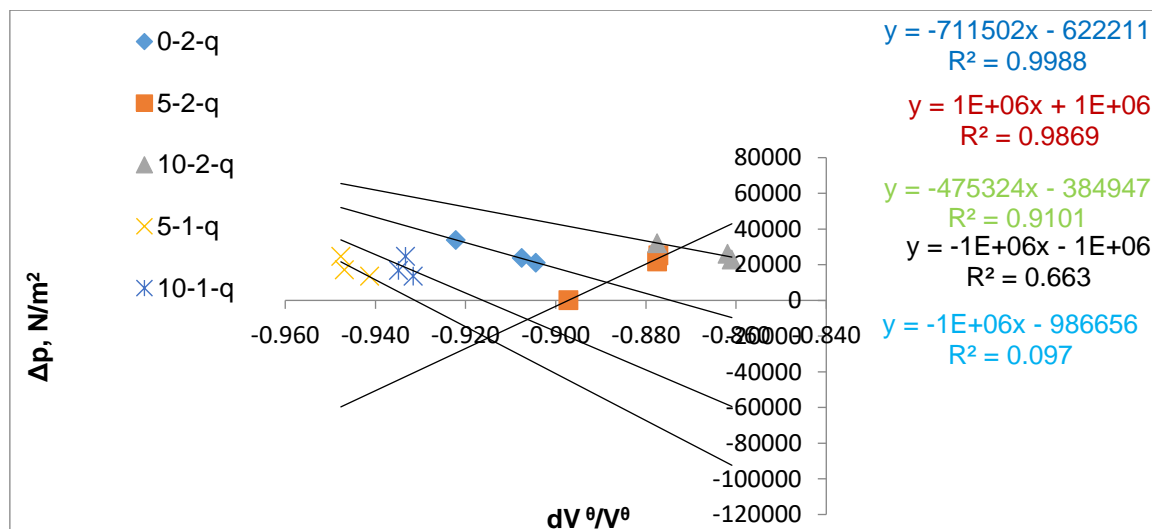
After oxygen saturation time at the concentrations difference of equilibrium and steady dissolved oxygen, the elastic potential energy of surface active substances defines the experimental data of  $\tan$ ,  $A^\theta$  and  $V^\theta$ :

$$Ue = \tan \frac{A^\theta \cdot V_0^\theta}{2} \quad (29)$$

## RESULTS AND DISCUSSION

**Table 1.** The aeration regimes define the operational parameters  $c-h-q$ ; air overpressure,  $\Delta p$ ; mass concentrations of equilibrium,  $\gamma^*$  and steady dissolved oxygen,  $\gamma_s$ ; surface tension of liquid phase,  $\sigma_L$ ; temperature of liquid monolayer,  $t_L$ ; Young's modulus of elasticity,  $E$ ; molar surface of the part of equilibrium dissolved oxygen after saturation time,  $A^\theta$ ; molar surface volume of the part of equilibrium dissolved oxygen after saturation time,  $V^\theta$ ; energy consumption via external source in oxygen molar introduction,  $W^\theta$ ; potential energy of elastic deformation,  $Ue$

Regimes	$\Delta p$	$\gamma_s$	$\gamma^*$	$\sigma_L$	$t_L$	$E$	$A^\theta$	$V^\theta$	$W^\theta_{exp}$	$Ue$
c-h-q	bar	g/m <sup>3</sup>	g/m <sup>3</sup>	Pa	°C	Pa	m <sup>2</sup>	m <sup>3</sup>	kJ/mol	kJ/mol
0-2-2	0,2077	7,5	10,56	0,076	13	-711502	855773,8	1,47E-05	3282	1,89E+04
0-2-6	0,2342	7,6	10,56	0,076	13	-711502	855773,8	1,47E-05	7680	1,89E+04
0-2-10	0,3344	7,9	10,39	0,076	14	-711502	858764,4	1,47E-05	7784	1,89E+04
5-2-2	0,2147	6,4	10,32	0,064	15	1,00E+06	-277921	-7,04E-06	4057	6,85E-11
5-2-6	0,2492	6,7	10,63	0,064	12,1	1,00E+06	-275124	-7,04E-06	10017	6,78E-11
5-2-10	0,0006	7	10,29	0,064	14,5	1,00E+06	-277439	-7,04E-06	8862	6,84E-11
10-2-2	0,2263	5,9	10,35	0,057	13,5	-384947	-147842	-3,40E-06	4702	7,54E+02
10-2-6	0,2581	6,1	10,52	0,057	13,2	-384947	-147687	-3,40E-06	10766	7,53E+02
10-2-10	0,3165	6,4	10,32	0,057	14,1	-384947	-148151	-3,40E-06	15781	7,56E+02
5-1-2	0,1344	6,4	10,16	0,0645	14,9	1,00E+06	-277825	-7,04E-06	6261	2,93E+03
5-1-6	0,169	6,6	10	0,065	15,6	1,00E+06	-278500	-7,04E-06	11755	2,94E+03
5-1-10	0,2434	6,5	9,85	0,065	15,8	1,00E+06	-278693	-7,04E-06	16317	2,94E+03
10-1-2	0,13445	5,8	10,18	0,057	14,9	-986656	-148564	-3,40E-06	7680	7,58E+02
10-1-6	0,1664	6	10,17	0,057	14,8	-986656	-148512	-3,40E-06	14240	7,57E+02
10-1-10	0,2434	5,9	10,17	0,0573	14,9	-986656	-148564	-3,40E-06	19862	7,58E+02



**Fig. 6.** Functional dependence fit the experimental data of air over pressure between air input and exit and the relative change of oxygen surface molar volume calculated according to Eq (18)

Young's modulus equal to the slopes of the linear functions obtained with strong correlation coefficient are in the agreement with the values found for rubber [5].

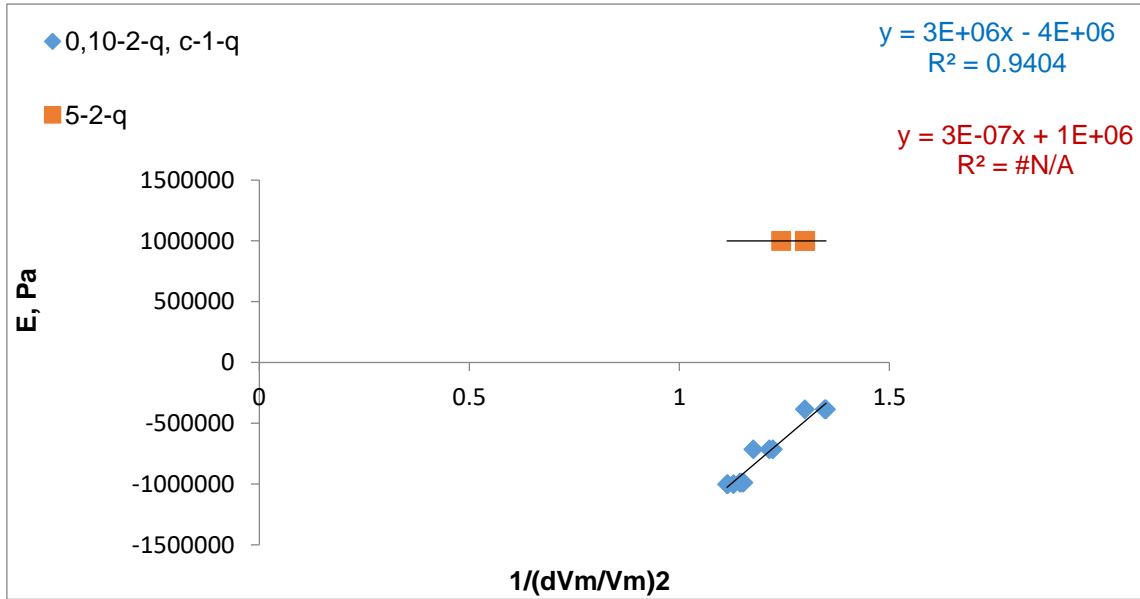


Fig. 7. Functional dependences fitted by the experimental data of Young's modulus and reciprocal value of square of relative elastic deformation, Eq. (26)

The slope enables the diagnostics of elastic potential energy presented in Table 1. The maximal potential energy closely to water critical pressure correspond to the regimes 0-2-q and minimal i.e. absence of elastic potential energy in the regimes 5-2-q.

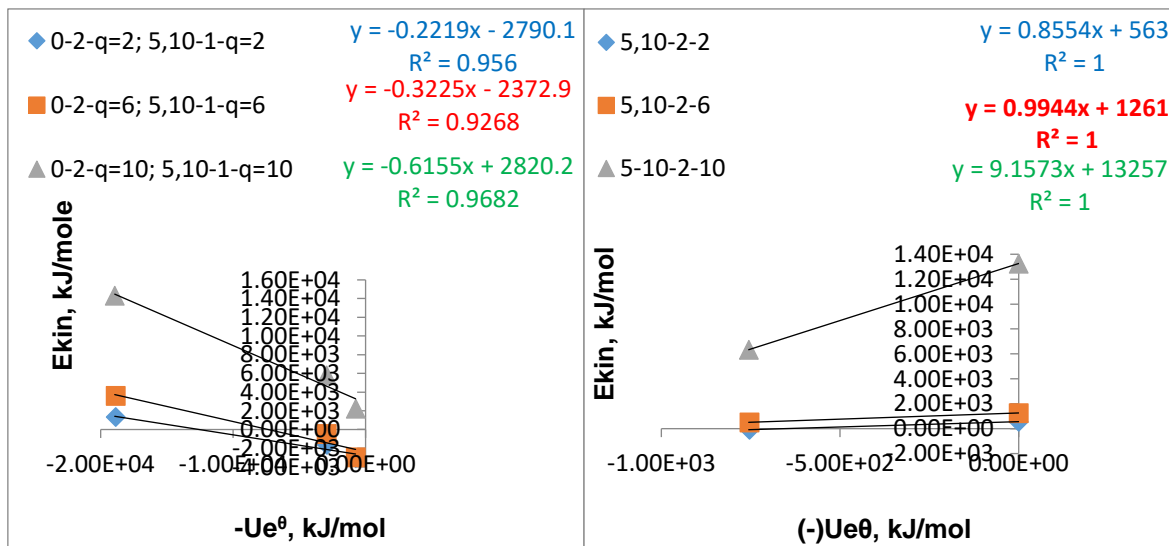


Fig. 8. The strong correlated linear functional dependence fit the experimental data of kinetic energy at air input defined in Eq. (9) and elastic potential energy Eq. (20) in Table 1

$$E_{kin,G} = -\frac{Ue_{in}}{\varepsilon_r} - \frac{Ue_{ex}}{\varepsilon_r} \quad (30)$$

Where:  $E_{kin} = p_{cr}(AH_z) - W_q^\theta$  acc. To Eq. (9) and  $x = -Ue_{in}$

The slope and free term enable the determination of relative electric permittivity and of elastic potential energies at air exit as well as of the electric permittivity of elastic material at liquid side of gas/liquid contact surfaces.



$$\varepsilon_r = \frac{1}{\tan} \quad \text{and} \quad Ue_{ex} = \varepsilon_r \cdot y_0 \quad (31)$$

## CONCLUSION

The obtained results enable to choose the optimized regime defined with aeration operational parameters: of added waste motor oil contents, water column heights and air flows, based on the least energy losses in relaxation processes, in the form of elastic potential energy. In the regimes 5,10-2-6, the zero elastic potential energy at air input is found (Fig.7). At air exit elastic potential energy (Fig. 8) is found 1261 kJ/mole. This value is:

- less than hydrogen critical pressure for the sum thermal vibration energy and Gibbs energy of adsorbed hydrated oxygen,
- and it is higher for the Gibbs energy of reversible evolved hydrogen electrode [4], than water vapor adsorption heat determined previously [6].

## REFERENCES

- [1] Simic S. N., Influence of System of Aeration on The Efficiency of The Biological Treatment of The Refinery Waste Water, Ph. D. Thesis, Faculty of Mechanical Engineering, Belgrade, Serbia, 2006
- [2] Stanojević M. M., Ševaljević M. M. , Simić S. N., Ševaljević M. V., Influence of water height in the aeration regimes with the same membrane diffuser on technical characteristics of aeration system, *Desalination and Water Treatment* **51**(2013) 4271
- [3] Ševaljević V.P., Simic N. S, Ševaljević M.M, IIZS 2023 , Zrenjanin
- [4] Ševaljević M. M., Simić S. N., Ševaljević P. V., Thermodynamic diagnostic of electron densities in gas bubbles in aerated saturated refinery wastewater, *Desalination and Water Treatment*, **42** (2012) 144
- [5] Bouaziz R., Truffault L., Borisov R.,Ovalle C.Laiarinandeanasana L., Miquelard-Garnier G.,and Fayolle B..Elastic properties of polychloroprene rubbers in tension and compression during ageing ( <http://creativecommons.org/licence/by/4.0/>)
- [6] Ševaljević V. M., Simić N.S.,Stanojević M. M., Pavlović M., Sevaljević M.M., Diagnostic of water vapor adsorption molar heat and accumulation at bubble surface during aeration treatment in saturation period, *Journal of Applied Engineering Science* 13(2015) 4, 333



## THE PROCESSES WHICH CONTROL MAXIMAL TRANSFER EFFICIENCY OF ELECTRIC POWER INVOLVED IN OXYGEN EQUILIBRIUM DISSOLUTION IN THE AERATED WATER

Petar V. Ševaljević<sup>1</sup>, Stojan N. Simić and Mirjana M. Ševaljević<sup>3</sup>

<sup>1</sup>Petrol, Ljubljana, Slovenia, <sup>2</sup> Faculty of Mechanical Engineering, East Sarajevo, Bosnia and Hecegovina, <sup>3</sup> University of Novi Sad, Technical Faculty "Mihajlo Pupin", Zrenjanin, Serbia

e-mail: [sevaljevic.mirjana@gmail.com](mailto:sevaljevic.mirjana@gmail.com)

**Abstract:** The aim of this work is the diagnostics of the processes which maintain minimal free energy state of oxygen, reached with maximal transfer efficiency of electric power involved in oxygen introduction in pure water layer of double water film of gas liquid contact surfaces in deep aeration treatment by membrane diffuser. Before and air flow is switched-on electron collisions are involved in current conduction at hydrogen ionization potential, and after air flow is switched-on at Paschen breakdown voltages. Maximal transfer efficiency enable equal resistances to breakdown current at both sides of interface: (a) in oxygen introduction from cascade produced bubbles in liquid phase between air input and exit (of  $\frac{1}{4}$  of electric power consumption via external source), (b) and in oxygen transport through electric double layer at floated electrode surfaces depending on the effect of aeration regime on the departures of Paschen breakdown voltage of hydrogen ionization potential, involved in faster isochoric bubble compression followed by isobaric bubble transport, or inversely.

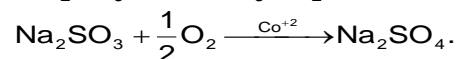
**Key words:** aeration retimes, gas /liquid contact surface, electric power, maximal transfer efficiency.

### INTRODUCTION

The most important energy sources in 20th century are based on refinery oil production. The purification treatments of refinery wastewater applied after primary coagulation and flocculation that can respond to environmental requirements are aeration treatments by fine membrane diffuser. The sustainable economic aeration process is based on the known parameters controlling maximal transfer efficiency of electric power via external source in oxygen transport from air to its equilibrium state in liquid phase.

### MATERIAL AND METHODS

The examined aeration treatments define the operational parameters (c-h-q) [1]: added oil content, *c* of 0, 5 and 10 gm<sup>-3</sup>, water column height, *h* of 1 m and 2 m at water volume 0.5 m<sup>3</sup> and 1 m<sup>3</sup>, and air flow, *q* of 2, 6 and 10 m<sup>3</sup>h<sup>-1</sup> in primary purified chemically *de*-oxygenated refinery wastewater by added Na<sub>2</sub>SO<sub>3</sub> and CoCl<sub>3</sub>·6H<sub>2</sub>O according to chemical equation:



In the primary purified wastewater was added viscous waste motor oil SAE 15 W-40, with 132.0 mm<sup>2</sup> s<sup>-1</sup>. It contains 0.310 % Ca; 0.039 % Zn; 44.87 ppm Al; 13.42 ppm Fe; 4.11 ppm <sup>1</sup>Cu; 0.98ppm Cr. The physical properties of the obtained samples are mass density (992.8, 996.1 and 997.3) kg m<sup>-3</sup>, kinematic viscosity (8.1·10<sup>-7</sup>, 9.1·10<sup>-7</sup> and 9.9·10<sup>-7</sup> m<sup>2</sup> s<sup>-1</sup>) and the surface tension (0.0762, 0.0648 and 0.0573 N m<sup>-1</sup>).

Complete investigation of aeration processes in charge reactor made of polypropylene started by reading the temperature of gas, surrounding air and of water in the column (Fig. 1). Air flow is switched-on through membrane diffuser using the low pressure blower (Fig.2), when the first bubble appears at bubble pressure equal to the air over-pressure measured as the difference in front before the air distributor, and after the orifice plate.

The applied same air distributor for fine aeration-bubble diameter, consists membrane Gummi-Jaeger GmbH the fine perforated material of etilene-propilene dimer, EPDM HD340 / 310 ( Fig. 2) After the opening of valve of air distributor in order to meet the demand of oxygen when the flow is stabilized, sampling of water from the column in equal time intervals starts ( $\Delta\tau = 60$  s) and the dissolved oxygen content is measured with HANNA instrument (Fig. 3.), until the same value is repeated in three time intervals of 1 min.



Fig. 1. Experimental installation for examination of aeration of refinery waste water [1]

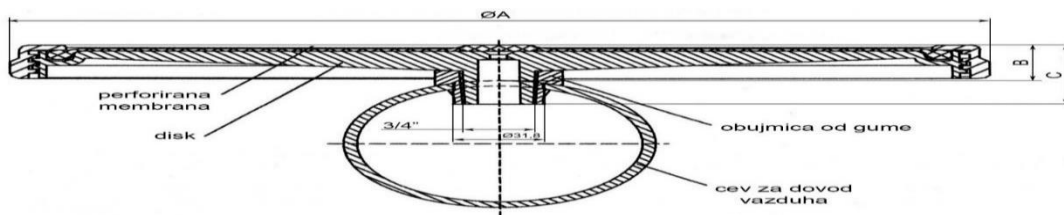


Fig. 2. Air distributor as disc membrane diffuser [1]



Fig. 3 Determination of oxygen content in small aliquot of aerated water using HANNA instrument with polarography sensor [1]

Transport coefficient of oxygen equilibrium dissolution according to Henry law in pure water layer of double water film,  $k_L a$  is determined on the basis of oxygen mass conservation law in gas and liquid phase, as the product of its vertical velocity ( $k_L$ , m/s) and specific contact surface between gas phase and liquid volume ( $a$ ,  $m^2/m^3$ ) [1].

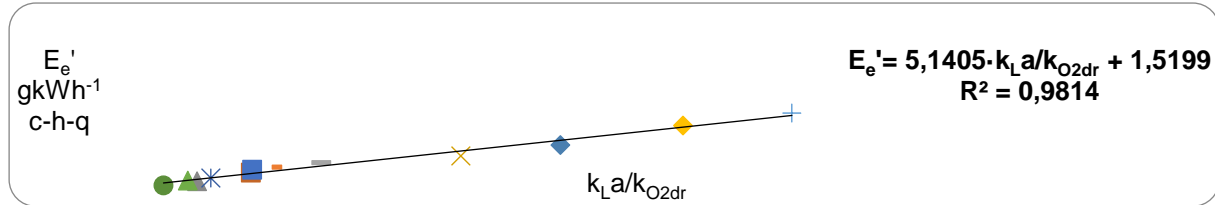
### Previous results

The data found for oxygen introduction rate constants are used in the determination of the energy efficiency of oxygen introduction,  $E'$  as the ratio of: (a) oxygen transport capacity,  $k_L a \cdot c^*$  defined as the product of oxygen transport coefficient and of equilibrium oxygen concentrations in pure water layer of double water film in gas/liquid contact surfaces,  $c^*$  defined to Henry law, (b) and the electric power consumed via external source,  $\Sigma P_i$  [1]:

$$E' = \frac{k_L a \cdot c^*}{\Sigma P_i}, \frac{g}{kWh} \quad (1)$$

Its reciprocal value defines the electric energy consumption in equilibrium introduction of one oxygen mole:

$$W^\theta = \frac{\Sigma P_i}{k_L a \cdot c^*}, \frac{kJ}{mole} \quad (2)$$



**Fig. 4.** Functional dependence fit the experimental data obtained for the examined aeration regimes: the real energy efficiency of oxygen transport,  $E_e'$ ,  $gkWh^{-1}$ , and the ratio between measured oxygen transport coefficients in liquid and gas phase  $(k_L a)/k_{O_2 dr}$  [2]

The slope,  $\tan$  of strong correlated linear functional dependence [2] defines the ratio between  $E_e'$ ,  $gkWh^{-1}$  and  $x = k_L a/k_{O_2 dr}$  (Fig. 4).

$$\tan = \frac{\Delta E_e}{\Delta(k_L a / k_{O_2 dr})} = 5.1405 g(O_2) kWh^{-1} \quad (3)$$

It determines:

(a) The energy efficiency can be defined per one mole of introduced oxygen proportional to the ratio between oxygen introduction and oxygen drift transport coefficient:

$$\Delta E_e^\theta = \tan \cdot \frac{\Delta(k_L a / k_{dr})}{M_r(O_2)} = \frac{5,1405}{32} (k_L a / k_{dr}), mole(O_2) kWh^{-1} \quad (4)$$

(b) And its reciprocal value defines the energy consumption in oxygen molar introduction that at equal oxygen drift and transport coefficient corresponds to water critical pressures:

$$W_{kLa=kdr}^\theta = \frac{32}{5,1405} 3,6 \cdot 10^6 = 22,41 MJmol^{-1} = p_{cr}(H_2O) \quad (5)$$

Where:

$$\tan = \frac{W^\theta}{(k_{dr} / k_L a)} = \frac{p_{cr}(H_2O),_{kLa=kdr}}{1} \quad (6)$$

defines the energy consumption in oxygen molar introduction in aeration treatment proportional to the ratio between oxygen drift and introduction transport coefficients:

$$W^\theta = \frac{k_{dr}}{k_L a} p_{cr}(H_2O),_{kLa=kdr} \quad (7)$$

### Theoretical approach

The electric power,  $P_i$  of electric current,  $I$  (of the most mobile electron in thermal equilibrium with hydrogen ion and other heavy particles at membrane diffuser), defines Ohm law at breakdown voltage of discharge through double water film of pure and contaminated water in gas liquid contact surface,  $U$  on the basis of resistances, at gas,  $R_G$  and at liquid side of gas/liquid interface  $R_L$ :

$$P_{in}^\theta = I \cdot U = \frac{U^2}{R_L + R_G} \quad (8)$$

Before air flow,  $q$  is switched-on, the electric power at air input control a resistance to current during breakdown at gas side in double water film of interface due to zero resistance at liquid side between two successive electron collisions:

$$P_{in} = \frac{U_{q=0}^2}{R_G} \quad (9)$$

Air flows electric resistances at liquid side in cascade produced bubble at the path between air input and exit that determine the power released in liquid volume,  $V_L$ :

$$P_L^\theta = I^2 \cdot R_L = \frac{U_q^2}{\varepsilon_0 \cdot (R_L + R_G)^2} R_L \quad (10)$$

According to Eq. (2) air flow influence on power consumption via external source due to the effects on intermolecular forces:

(a) dependent on electric permittivity of hydration layer at liquid side of contact surface:

$$P_{in} = k_L a \cdot c^* \frac{W^\theta - W_{kdr=0}^\theta}{\varepsilon} \quad (11)$$

(b) and on electric permittivity in air bubbles,  $\varepsilon_0$  in water volume,  $V_L$  at input pressure,  $p_{in}$ :

$$P_L = \frac{k_{dr} P_{in,O_2} \cdot V_L}{\varepsilon_0} \quad (12)$$

First and second derivation of Eq. (10) indicates to the maximal efficiency of input power in its transfer reached at equal electric resistances at liquid and gas side of interface:

$$R_L = R_G \quad (13)$$

Where:

$$P_L^\theta = \frac{emf^2}{4R_G^2} \quad (14)$$

The maximum of transferred power corresponds to  $\frac{1}{4}$  of breakdown power in Eq. (9):

$$P_{L_{max,eff}}^\theta = \frac{P_{in}^\theta}{4} \quad (15)$$

The substitution of the Eqs. (11) and (12) in Eq. (16) results:

$$k_L a \cdot c^* \frac{W^\theta - W_{kdr=0}^\theta}{4\varepsilon} = \frac{k_{dr} P_{in,O_2} \cdot V_L}{\varepsilon_0} \quad (16)$$

After the rearrangement it gives the form:

$$W^\theta = \varepsilon_r \cdot 4k_{dr} \frac{P_{in,O_2} \cdot V_L}{k_L a \cdot c^*} + W_{kdr=0}^\theta \quad (17)$$

Where:

$$y = W^\theta \quad \text{and} \quad x = 4 \frac{0.2q}{V_L} \frac{P_{in,O_2} \cdot V_L}{k_L a \cdot c^*} \quad (18)$$

Strong correlated linear functional dependence enables the diagnostics:

- (a) of breakdown power at gas side of interface equal to free term,
- (b) and of relative electric permittivity of hydration layer,  $\varepsilon_r$  equal to the slope:

$$W_{q=0}^\theta = y_0 \quad \text{and} \quad \varepsilon_r = \tan \quad (19)$$

According to the electric energy conservation law the electric energy consumption by air flow in oxygen molar introduction enable electric discharging at voltages defined with Paschen breakdown in Helmholtz planes of charged electrode,  $U_{PB,q}$  determined in Eq. (19) and  $U_{PB}$  determined on the basis of Paschen curve:

$$\frac{W_q^\theta - W_{q=0}^\theta}{\varepsilon} = \frac{F \cdot (U_{PB} - U_{PB,q=0})}{\varepsilon_0} \quad (20)$$

The rearrangement of Eq. (20) enables the determination of the energy consumption in electric double layers defined by relative electric permittivity of its Helmholtz planes

$$W_q^\theta = \varepsilon_r \cdot F \cdot (U_{PB} - U_{PB,q=0}) + W_{\Delta U=0}^\theta \quad (21)$$

Where:

$$y = W_q^\theta \quad \text{and} \quad x = F \cdot (U_{PB} - U_{PB,q=0}) \quad (22)$$

$$\tan = \varepsilon_r \quad \text{and} \quad y_0 = W_{(U_{PB}=U_{PB,q=0})}^\theta \quad (23)$$

The breakdown potential depend on bubble pressure,  $p_b$  and on minimal collisional path,  $d$  (defined by temperature of liquid phase, its viscosity,  $\eta$  and on diffusion coefficient of hydrogen molecule in water,  $D$  ( $H_2$ )<sub>in water</sub> =  $5.8 \cdot 10^{-9} \text{ m}^2/\text{s}$ )

$$d = \frac{k_B T}{6\pi\eta D} \quad (24)$$

According to Paschen curve [4]:

$$U_{PB,q} = \frac{A \cdot pd}{B + \ln pd} \quad (25)$$

The constants A and B in Eq. (25) equal for different gases [4] can be determined on the basis known,  $p_b \cdot d$  and hydrogen ionization potential corresponding to breakdown potential at gas side, and then applied in the determination of Paschen breakdown potentials switched on after air flow. The determination of constants A and B, enables the rearranged form of Eq. (25):

$$\frac{1}{pd} = \frac{A}{B \cdot U_{PB}} + \frac{1}{B} \cdot \frac{\ln p_b \cdot d}{p_b \cdot d} \quad (26)$$

Where:

$$y = \frac{1}{p_b \cdot d} \quad \text{and} \quad x = \frac{\ln p_b \cdot d}{p_b \cdot d} \quad (27)$$

In strong correlated linear functional dependence Eq. (26) with the experimental data enable to calculate the constants A i B :

$$A = y_0 \cdot B \cdot U_{PB,q=0} \quad \text{and} \quad B = \frac{1}{\tan} \quad (28)$$

The found constants A and B enable the diagnostics of Paschen breakdown potentials,  $U_{PB,q}$  on the basis of Eq. (25).

## RESULTS AND DISCUSSION

**Table 1.** The aeration regimes defined with operational parameters c-h-q, oxygen volume transport coefficient, pressure at air input and exit,  $p_i$  and  $p_a$ , oxygen drift and introduction rate constants,  $k_{dr}$  and  $k_{La}$ , mass concentrations of oxygen equilibrium dissolved according to Henry law,  $\gamma^*$ , energy consumption via external source in oxygen molar introduction,  $W^\theta$ ,  $n$ , product between bubble pressure,  $p_b$  with breakdown distance,  $d$ , and Paschen breakdown voltage,  $U_{PB}$

Regimes	$p_{in}$	$p_a$	$k_{dr}$	$k_{La}$	$W^\theta$	$\gamma^*$	$p_b \cdot d$	$U_{PB}$
c-h-q	bar	bar	1/h	1/h	kJ/mole	$\text{g} \cdot \text{m}^{-3}$	$\text{Pa} \cdot \mu\text{m}$	V
0-2-2	1,213	1,005	0,4	2,51	3282	10,56	0,95	15,2
0-2-6	1,24	1,005	1,2	2,66	7680	10,56	1,07	16,83
0-2-10	1,332	0,9981	2	4,68	7784	10,39	1,53	22,9
5-2-2	1,213	0,9981	0,4	2,04	4057	10,32	0,87	14,2
5-2-6	1,473	0,9981	1,2	2,03	10017	10,63	1	15,98
5-2-10	1,003	1,0026	2	4,1	8862	10,29	0	31,56
10-2-2	1,231	1,005	0,4	1,75	4702	10,35	0,84	13,75
10-2-6	1,263	1,005	1,2	1,89	10766	10,52	0,96	15,36
10-2-10	1,321	1,005	2	2,29	15781	10,32	1,18	18,33
5-1-2	1,135	1,0011	0,8	2,86	6261	10,16	0,55	9,57
5-1-6	1,17	1,0011	2,4	3,74	11755	10	0,69	11,62
5-1-10	1,244	1,001	4	4,83	16317	9,85	0,99	15,84

10-1-2	1,135	1,0011	0,8	2,34	7680	10,18	0,5	8,91
10-1-6	1,167	1,001	2,4	3,11	14240	10,17	0,62	10,65
10-1-10	1,244	1,001	4	3,95	19862	10,17	0,91	14,69

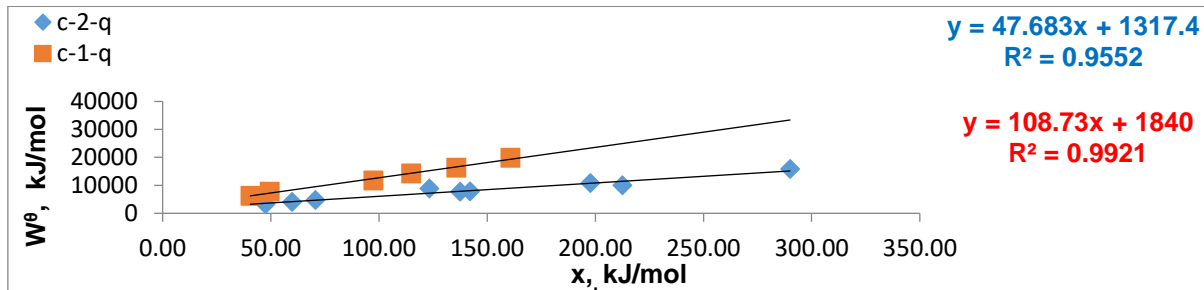


Fig. 5. The strong correlated diagnostics data according to Eqs.(17) and (18).

The obtained strong correlated linear functions in Fig. 5 define:

- (a) for water column 2 m high, breakdown potential at broken air flow,  $W^{\theta}_{kdr=0} = 1317.4$  kJ/mole, that corresponds to hydrogen and oxygen ionization potentials  $E_{ion(H)kdr=0} = 13.595$  eV  $E_{ion(O)kdr=0} = 13.614$  eV, and also define the relative electric permittivity at oxygen drift,  $\epsilon_{r, H_2O (Kdr)} = 47.7$  closely to water boiling point ( $\epsilon_{r, H_2O, 100 C} = 55.6$ )
- (b) for water column 1 m high, breakdown potential at broken oxygen drift,  $W^{\theta}_{kdr=0} = 1840$  kJ/ mole equal to the sum of hydrogen dissociation ionization, and affinity to electron that indicates to irreversible recombination of ionized hydrogen; and the relative electric permittivity at oxygen drift,  $\epsilon_{r, H_2O} = 108.7$  closely to water crystallization point ( $\epsilon_{r, H_2O, 0 C} = 87.9$ ).

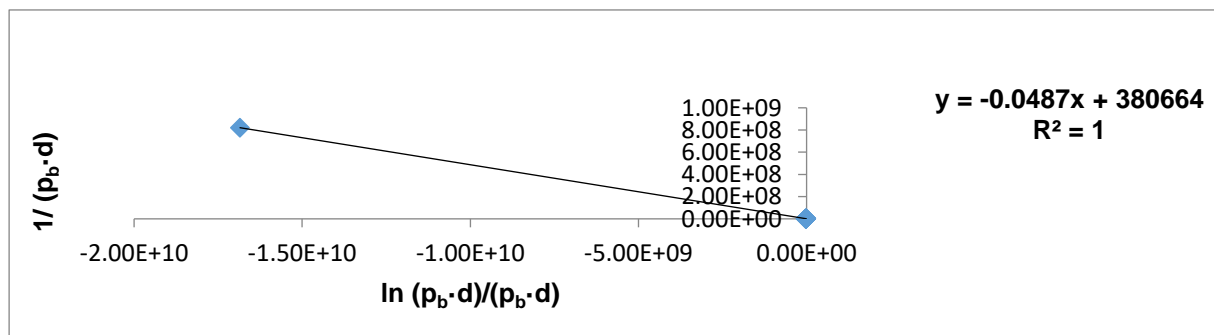


Fig. 6. The strong correlated Eqs. (21) a Strong correlated Eq. (21) ( $R^2=1$ ) at Paschen breakdown potential at broken air flow equal to hydrogen ionization potential defines:

$$A = 1.07 \cdot 10^8 \text{ Pa} \cdot \text{m} \quad \text{and} \quad B = -20.5339 \text{ (Pa} \cdot \text{m)}^{-1}$$

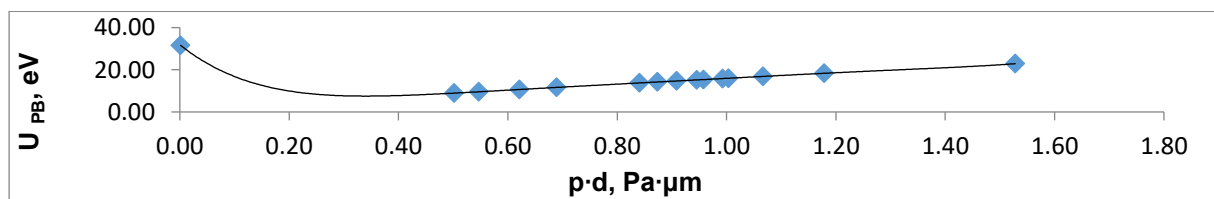
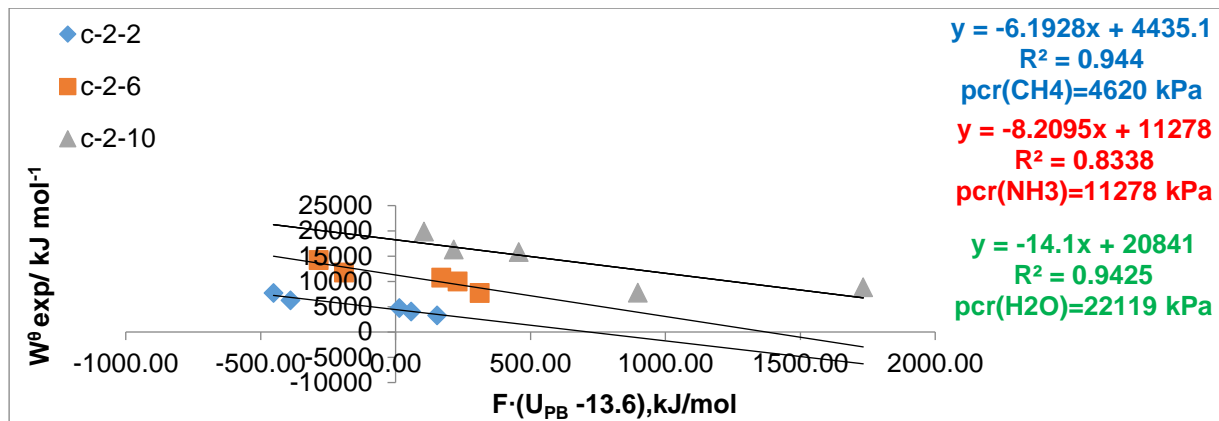


Fig. 7. The Paschen curve (Eq. (25) fitted by the data of Paschen breakdown potentials (Table 1)





**Fig. 8.** The strong correlated linear functions Eqs. (21) used in the diagnostic of  $\varepsilon_r$  and of  $W^\theta = p_{cr}(AH_z)$  where  $U_{PB} = E_{ion}(H) = 13.6\text{eV}$ , Helmholtz planes in electric double layer involved in current breakdown in the aeration regimes by the equal air flows

Transfer efficiency of electric energy in electric double layer of solid charged substances control:

$$\varepsilon_r = \tan \quad \text{and} \quad W_{(U_{PB}=U_{PB,q=0})}^\theta = y_0$$

- the relative electric permittivity at minimal examine air flow  $2\text{ m}^3/\text{h}$  of material involved in isochoric processes in inner Helmholtz planes ( $\varepsilon_r = 6$ ) up to air flow  $10\text{ m}^3/\text{h}$  ( $\varepsilon_r = 14$ ) involved in isentropic adiabatic processes [6],
- and the energy consumption per one mole of equilibrium dissolved oxygen corresponds to critical pressure of  $\text{CH}_4$ ,  $\text{NH}_3$  and  $\text{H}_2\text{O}$  where  $p_{cr}(AH_z)$  where  $U_{PB} = E_{ion}(H) = 13.6\text{eV}$  at air flow  $2\text{ m}^3/\text{h}$ ,  $6\text{ m}^3/\text{h}$  and  $10\text{ m}^3/\text{h}$ , respectively.

Equal hydrogen ionization potentials at both sides of contact surfaces is coupled by titrations of specifically adsorbed atom (C, N, O) in the regimes by first step:

(a) where first isobaric hydrogen recombination than (at critical pressure of gaseous product lower than Paschen breakdown voltage) follow isochoric bubble compression (according to the data in Fig. 7.)

(b) or where first specifically adsorption of titrated atom (at Paschen breakdown voltage lower than critical pressure of gaseous product) follow isobaric bubble extension (according to the data in Fig. 7.) in the regimes 5-1-2, 6 and 10-h-2),

Maximal transfer efficiency of oxygen from Helmholtz planes in electric double layer at equal resistances to breakdown current at both sides of cascade formed bubble surfaces enable critical pressure of gaseous products in coupled processes of hydrogen reversible recombination [4], followed by titrations of adsorbed elements at floated electrode surfaces at constant air flow.

$$W_q^\theta = \varepsilon_r \cdot F \cdot (U_{PB} - E_{ion}(H)) + W_{\Delta U=0}^\theta \quad (29)$$

Released kinetic energy,  $E_{kin,in}$  defines the differences between critical pressure and the energy consumption in oxygen molar equilibrium introduction:

$$E_{kin,in} = p_{cr}(AH_z) - W_q^\theta \quad (30)$$

## CONCLUSION

Maximal transfer efficiency in oxygen introduction between air and input is enabled at equal resistances to breakdown current at both sides of cascade formed bubble surfaces:

- at hydrogen ionization potential, at air flow in liquid phase broken, at relative electric permittivity of hydration layers in isochoric increased temperatures in bubble compression step, in water column  $2\text{ m}$  high

- (b) and at coupled hydrogen ionization and recombination potential at gas sides of bubble surface at air flow broken, at relative electric permittivity of hydration layers in adiabatic bubble extension step, in water column 1 m high,
- (c) and at equal resistances to breakdown current at critical pressure of gaseous products of hydrogen recombination and hydrogen titration of adsorbed elements in Helmholtz planes of electric double layer at floated electrode surfaces, at constant air flow. Released kinetic energy defines the differences between critical pressure and the energy consumption in oxygen molar equilibrium introduction.

## REFERENCES

- [1] Simic S. N., Influence of System of Aeration on The Efficiency of The Biological Treatment of The Refinery Waste Water, Ph. D. Thesis, Faculty of Mechanical Engineering, Belgrade, Serbia, 2006
- [2] Stanojević M. M., Ševaljević M. M., Simić S. N., Ševaljević M. V., Influence of water height in the aeration regimes with the same membrane diffuser on technical characteristics of aeration system, *Desalination and Water Treatment* **51**(2013) 4271
- [3] Ševaljević M. V., Simić S. N., Stanojević M. M., Pavlović M. and Ševaljević M.M., Diagnostic of water vapor molar heat and accumulation at bubble surface during aeration treatment in saturation period, *Journal of Applied Engineering Science*, 13 (2015) 225
- [4] Husain E., Nema R., Analysisi of Paschen curves for air, N<sub>2</sub>, and SF<sub>6</sub> using the Townsend breakdown equation, *IEEE Transaction on Electrical Insulation EI-17* **4** (1982) 350-353
- [5] Conaail F. P, Zhang P.Nunes F. B., Jordan I., Conta A.,and Worner H. J., Ionization energy of liquid water revisited, *The Journal of Physical Chemistry letters*, **11** (2020) 1789:1794
- [6] Ševaljević M. M., Simić S. N., Ševaljević P. V., Thermodynamic diagnostic of electron densities in gas bubbles in aerated saturated refinery wastewater, *Desalination and Water Treatment*, **42** (2012) 144
- [7] Simić S. N., Ševaljević M. M., Stanojević M. M., Ševaljević P. V., Thermodynamic diagnostics of the depolarization overpotentials and electron temperature in contact surfaces in aerated refinery wastewater, *Desalination and Water Treatment* **52** (2014) 706



## IMPACT OF RAINFALL ON THE MICROPLASTICS BEHAVIOR IN THE ENVIRONMENT

**Maja Vujić<sup>1</sup>, Eleonora Terečik<sup>2</sup>, Sanja Vasiljević<sup>1\*</sup>, Malcolm Watson<sup>1</sup>,  
Đurđa Kerkez<sup>1</sup>, Jasmina Agbaba<sup>1</sup>, Aleksandra Tubić<sup>1</sup>**

<sup>1</sup>University of Novi Sad, Faculty of Sciences, Department of Chemistry, Biochemistry and Environmental Protection, Trg Dositeja Obradovića 3, 21000 Novi Sad, Republic of Serbia

<sup>2</sup>Technical College of Applied Sciences in Zrenjanin, Đorđa Stanimirovića 23, 23000 Zrenjanin, Republic of Serbia  
e-mail: [sanjav@dh.uns.ac.rs](mailto:sanjav@dh.uns.ac.rs)

**Abstract:** In recent decades, environmental pollution from microplastic (MPs), plastic particles smaller than 5 mm, and climate change have received international attention. However, these two issues have been primarily investigated separately hitherto, although they exhibit a cause-and-effect relationship. In water environments, previous researches have mainly been focused on investigating the impact of human-related activities on microplastic degradation, but little is known about non-anthropogenic effects on microplastic distribution. In this paper, the main focus was to investigate impact of rainfall on microplastic behavior in the environment. The preliminary results of this study imply a close relationship between rainfall and plastic behavior in the environment and the adsorption possibilities of metal adsorption on plastics and microplastics. It also opens up some questions regarding possible leaching of metals from plastic surface into the environment highlighting the importance of this research.

**Key words:** plastic, microplastic, rainfall, metals, sorption

### INTRODUCTION

In the past few years, plastics have been widely utilized in industries, agriculture, medical treatment, and products that closely relate to human daily life. Due to its exceptional properties, such as low cost, high resistance to corrosion, light weight, durability, and outstanding insulating properties, today its usage is inconceivable. Despite the convenience plastic products bring, a growing amount of plastic waste is inevitable [1,2]. The advantages of plastics, which are mentioned earlier, can lead to serious environmental problems due to their persistence, accumulation, and strong resistance to degradation when they are transformed into plastic waste [3].

Microplastics (MPs), which are commonly referred to as plastic particles <5 mm in size, have received a significant amount of attention in scientific world [4–9]. Due to their specific physical properties, microplastics can have negative effects on organisms. Furthermore, MPs that are ingested can result in a loss of energy, growth inhibition, oxidative stress and even death of some organisms. On the other hand, various toxic leachable additives are frequently added in the process of plastic production to modify the material properties of polymers. Moreover, MPs have the potential to adsorb organic pollutants and metals, which can increase the potential exposure risks of these pollutants [8,10–13].

Research on MPs pollution in freshwaters and soil is scarce compared to marine ecosystems. Furthermore, numerous studies on freshwater and soil have given priority to evaluating the level of MPs pollution, the level of MPs distribution and its source. There is a lack of knowledge about the impact of non-anthropogenic factors, such as rainfall, on MPs pollution. Rainfall has been proven to be one of a significant factors for other pollutants and materials in previous studies. As it's been implied by other authors, the transfer of components adsorbed on MPs and MPs itself from landfills to different water bodies may be influenced by rain or runoff [2].

Therefore, rainfall can be the most direct way for organic and inorganic pollutants runoff from MPs surface. In order to fill these knowledge gaps, in this study, for the first time in Serbia, the authors did preliminary research regarding impact of rainfall on the microplastics behavior originated from plastic net typically used as in gardens and fields.

## MATERIAL AND METHODS

In order to investigate potential influence of large amount of rainfall on MPs behavior in the environment the experiments were conducted in laboratory-controlled conditions. For the experiment, in this study were used plastic net (five pieces of plastic net sizes 10x10 cm) commercially available for gardens and fields. Additionally, water used for simulating large amount of rainfall, when it was missing, was a tap water. The characteristics of the water mixture collected during the experiment are presented in Table 1.

In order to simulate rainfall, an ordinary glass bottle with a perforated cap was used. When there was no rainfall, watering was performed 3-5 times a day. With the increasing of water volume in collecting can with plastic net, the watering was reduced to twice a day, in the morning and in the afternoon. The rainfall simulation was performed slowly, and the amount of water used was 100 ml. Once a month, the water is removed from the can and analyzed. In this paper, results for the first, preliminary, month are presented.

### Analytical methods

During the experiment monitoring of selected parameters (the amount of rainfall, temperature, air humidity, air pressure and the amount of water used for irrigation) were conducted. Additionally, pH value, electrical conductivity (EC), concentration of total organic carbon (TOC) and total content of selected metals were measured in water samples before and after watering the MPs. The pH value of the water samples was measured using a pH-meter 340i, WTW, SenTix®21 electrodes, according to the SRPS H.Zi.111:1987 method. Additionally, the analysis of electrical conductivity of water samples were performed using a Hanna model HI 933000 conductometer. TOC in water samples were analyzed using the Elementar LiquiTOCII apparatus according to the SRPS ISO 8245:2007 method.

The total content of selected metals (B, Al, Cr, Mn, Co, Ni, Cu, As, Cd, Sn, Ba and Pb) in the mixture rainfall water and tap water before and after watering plastic net was determined by using Inductively coupled plasma mass spectrometry with mass detector (ICP-MS) (Agilent Technologies 7700 Series ICP-MS). Method detection limits for the selected metals were 0.001 mg/L.

## RESULTS AND DISCUSSION

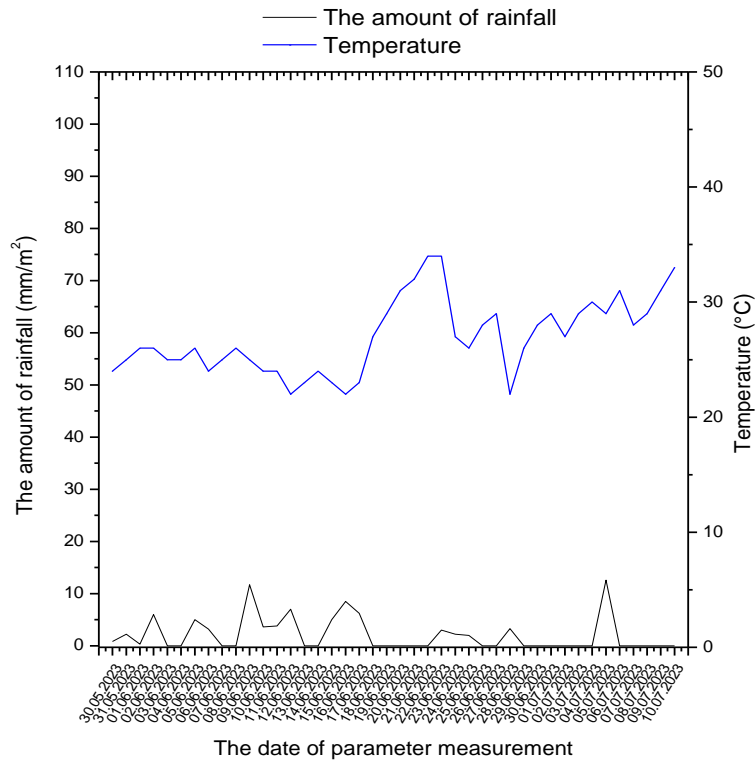
### General experiment parameters monitoring

The mixture of tap water and rainfall collected in separated can has a high concentration of total organic carbon 36.6 mgC/L, turbidity 14.4 NTU and electro conductivity 1.26 mS/cm which is presented in table 1. Additionally, monitoring of the amount of rainfall, temperature, air humidity, air pressure and the amount of water used for irrigation is shown in Fig. 1. The results presented in Fig. 1. imply that the amount of rain in this experimental period fluctuated and ranged from 0 to 12.6 mm/m<sup>2</sup>.

*Table 1. Characteristics of the water used during the experiment*

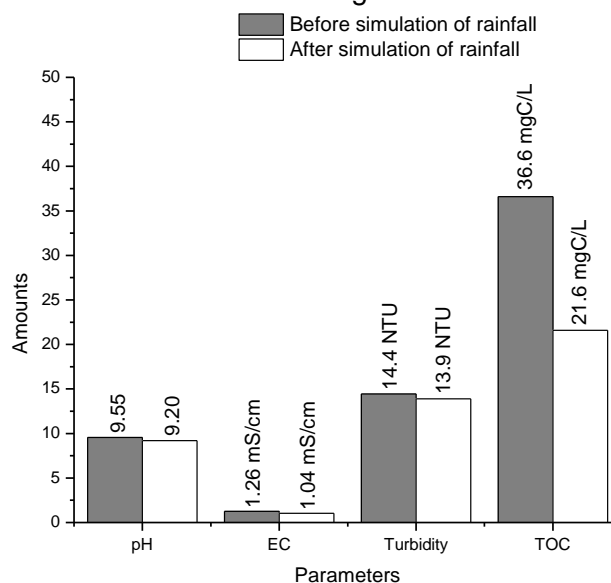
Parameter	Method designation	Method description	MDL	PQL	Water before contact with plastic
pH	SRPS H.Z1.111:1987	Electrochemical	-	-	9.55
Electro conductivity 25 °C (mS/cm)	SRPS EN27888:1993	Conductometry	0.51	2.57	1.26
Turbidity (NTU)	APHA 2130 B	Nephelometry	-	-	14.44

Total organic carbon (mgC/L)	SRPSISO8245:2007	Combustion and IR	0.20	0.46	36.6
------------------------------	------------------	-------------------	------	------	------



**Fig. 1.** Monitoring of the amount of rainfall, temperature, air humidity, air pressure and the amount of water during the one-month period Figure caption

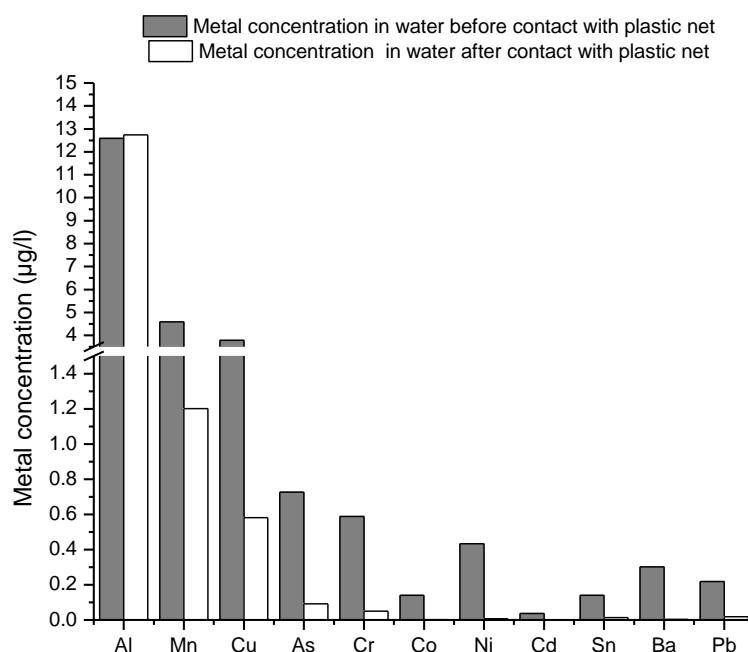
Furthermore, based on the Fig. 1. the rainfall simulation with 100 ml of tap water followed the data with no rainfall. Additionally, temperature measured during this one-month period and shown in Fig. 1 imply high temperature fluctuations ranging from 22 °C to 34 °C and possible impact on plastic behavior in the environment. Furthermore, in order to investigate impact of simulated rainfall on plastic behavior, pH, TOC, EC and turbidity was measured also in water after watering the plastic net which is shown in Fig. 2.



**Fig. 2.** pH value, electrical conductivity (EC), turbidity and concentration of total organic carbon (TOC) before and after simulation of rainfall influence of plastic net behaviour

The results shown in Fig. 2 imply that values for all analyzed parameters decrease after contact with plastic net. Therefore, pH value decreases from 9.55 to 9.2, EC from 1.26 to 1.04 mS/cm and turbidity from 14.4 NTU to 13.9 NTU. The highest decrease was detected in TOC values where the amount varied from 36.6 mgC/L before contact with plastic net to 21.6 mgC/L. Based on the results presented in Fig. 2, it can be assumed that certain amount of organic carbon has been adsorbed on the plastic net [13–15].

In order to get more information about simulation of rainfall on plastic net concentration of selected metals before and after watering were conducted by using ICP-MS and the results are presented in Fig. 3.



**Fig. 3.** Concentration of Al, Mn, Cu, As, Cr, Co, Ni, Cd, Sn, Ba and Pb in water before and after contact with the plastic net

Generally, results presented in Fig 3. imply that concentrations for all selected metals (except Al) decreased after simulation of rainfall and its contact with plastic net. Furthermore, based on the results presented in Fig. 3, it can be assumed that the adsorption of selected metals also occurred on plastic net. Based on the obtained results, the highest adsorption percentage was detected for Cd, 99.1%, and the lowest for Mn, 73,8%.

In sum, the topic of emerging concern is the impact of rainfall on MPs' behavior in the environment and the potential adsorption of heavy metals. MPs that are ubiquitous can be transported from the soil to underground waters, through the food chain, and different organisms to humans, resulting in a serious threat to human health. It is unfortunate that the actual risks of exposure to MPs and metals in human health are not fully known [13,16].

## CONCLUSION

This preliminary study demonstrated a close relationship between rainfall and plastic behavior in the environment. Obtained results, and adsorption possibilities of adsorption of organic matter and metals implies high importance of investigation of non-anthropogenic factors, especially rainfall. It is important to continue research in this field with high frequency sampling in order to get accurate conclusions and calculations regarding adsorption affinity of TOC and metals on plastics and microplastics. It also opens up other questions regarding possible leaching of metals from plastic surface into the environment which is something that this working group is planning to investigate in future period.

**Acknowledgments:** The authors gratefully acknowledge the financial support of the Provincial Secretariat for Higher Education and Scientific Research (Project No. 142-451-3182/2022-01/2) and the Ministry of Science, Technological Development and Innovation of the Republic of Serbia (Grant No. 451-03-47/2023-01/200125).

## REFERENCES

- [1] Geyer, R.; Jambeck, J.R.; Law, K.L. Production, Use, and Fate of All Plastics Ever Made. *Science Advances*, 3, 25–29, 2017.
- [2] Xia, W.; Rao, Q.; Deng, X.; Chen, J.; Xie, P. Rainfall Is a Significant Environmental Factor of Microplastic Pollution in Inland Waters. *Science of the Total Environment*, 732, 2020.
- [3] Roy, P.K.; Hakkarainen, M.; Varma, I.K.; Albertsson, A.-C. Degradable Polyethylene: Fantasy or Reality. *Environmental Science & Technology*, 45, 4217–4227, 2011.
- [4] Zhao, S.; Zhu, L.; Li, D. Microplastic in Three Urban Estuaries, China. *Environmental Pollution*, 206, 597–604, 2015.
- [5] Wright, S.L.; Thompson, R.C.; Galloway, T.S. The Physical Impacts of Microplastics on Marine Organisms: A Review. *Environmental Pollution*, 178, 483–492, 2013.
- [6] Wright, S.L.; Kelly, F.J. Plastic and Human Health: A Micro Issue? *Environmental Science & Technology*, 51, 6634–6647, 2017.
- [7] Chen, C.F.; Ju, Y.R.; Lim, Y.C.; Hsu, N.H.; Lu, K.T.; Hsieh, S.L.; Dong, C. Di; Chen, C.W. Microplastics and Their Affiliated PAHs in the Sea Surface Connected to the Southwest Coast of Taiwan. *Chemosphere*, 254, 2020.
- [8] Vujić, M.; Vasiljević, S.; Rocha Santos, T.; Agbaba, J.; Čepić, Z.; Radonić, J.; Tubić, A. Improving of an Easy, Effective and Low-Cost Method for Isolation of Microplastic Fibers Collected in Drying Machines Filters. *Science of the Total Environment*, 892, 164549, 2023.
- [9] Vasiljević, S.; Vujić, M.; Agbaba, J.; Federici, S.; Ducoli, S.; Tomić, R.; Dra Tubić, A.-4 Efficiency of Coagulation/Flocculation for the Removal of Com-2 Plex Mixture of Textile Fibers from Water, *Processes*, 11, 2023.
- [10] Lončarski, M.; Tubić, A.; Isakovski, M.K.; Jović, B.; Apostolović, T.; Nikić, J.; Agbaba, J. Modelling of the Adsorption of Chlorinated Phenols on Polyethylene and Polyethylene Terephthalate Microplastic. *Journal of the Serbian Chemical Society*, 85, 697–709, 2020.
- [11] Lončarski, M.; Gvoić, V.; Prica, M.; Cveticanin, L.; Agbaba, J.; Tubić, A. Sorption Behavior of Polycyclic Aromatic Hydrocarbons on Biodegradable Polylactic Acid and Various Nondegradable Microplastics: Model Fitting and Mechanism Analysis. *Science of the Total Environment*, 785, 2021.
- [12] Wang, Q.; Zhang, Y.; Wangjin, X.; Wang, Y.; Meng, G.; Chen, Y. The Adsorption Behavior of Metals in Aqueous Solution by Microplastics Effected by UV Radiation. *J China Environmental Science*, 87, 272–280, 2020.
- [13] Liu, S.; Huang, J.H.; Zhang, W.; Shi, L.X.; Yi, K.X.; Yu, H.B.; Zhang, C.Y.; Li, S.Z.; Li, J.N. Microplastics as a Vehicle of Heavy Metals in Aquatic Environments: A Review of Adsorption Factors, Mechanisms, and Biological Effects. *Journal of Environmental Management*, 302, 113995, 2022.
- [14] Ateia, M.; Zheng, T.; Calace, S.; Tharayil, N.; Pilla, S.; Karanfil, T. Sorption Behavior of Real Microplastics (MPs): Insights for Organic Micropollutants Adsorption on a Large Set of Well-Characterized MPs. *Science of the Total Environment*, 720, 2020.
- [15] Wu, W.; Hu, Y.; Guo, Q.; Yan, J.; Chen, Y.; Cheng, J. Sorption/Desorption Behavior of Triclosan in Sediment-Water-Rhamnolipid Systems: Effects of PH, Ionic Strength, and DOM. *Journal of Hazardous Materials*, 297, 59–65, 2015.
- [16] Cao, Y.; Zhao, M.; Ma, X.; Song, Y.; Zuo, S.; Li, H.; Deng, W. A Critical Review on the Interactions of Microplastics with Heavy Metals: Mechanism and Their Combined Effect on Organisms and Humans. *Science of The Total Environment*, 788, 147620, 2021.





## CONTENT OF POTENTIALLY TOXIC ELEMENTS IN SOIL OF URBAN PARKS IN NOVI SAD

**Aleksandra Mihailović<sup>1</sup>, Robert Lakatoš<sup>1</sup>, Selena Samardžić<sup>1</sup>, Savka Adamović<sup>1</sup>,  
Jordana Ninkov<sup>2</sup>, Dragan Adamović<sup>1</sup>, Stanko Milić<sup>2</sup>**

<sup>1</sup>University of Novi Sad, Faculty of Technical Sciences, Novi Sad, Serbia

<sup>2</sup>Institute of Field and Vegetable Crops, National Institute of the Republic of Serbia,  
Novi Sad, Serbia

e-mail: [zandra@uns.ac.rs](mailto:zandra@uns.ac.rs)

**Abstract:** This paper reports on the presence of potentially toxic elements in the soil of urban parks in the city of Novi Sad, Serbia. The surface soil samples (0-10 cm depth) were collected in seven urban parks. The chemical properties of the soil, as well as the particle size distribution of the 2 mm fraction, were determined. Pseudo-total concentrations and available (in EDTA) content of As, Cd, Co, Cr, Cu, Ni, Pb, and Zn were measured using an ICP-OES device. The samples were analyzed for total Hg content using Direct Mercury Analyzer. The limit value was exceeded by two soil samples, one for Cu (44.9 mg/kg) and one for Ni (50.4 mg/kg).

**Keywords:** PTEs, soil, urban parks, risk assessment

### INTRODUCTION

Trace elements in the soil that are most often associated with environmental toxicity are cadmium, chromium, cobalt, copper, iron, lead, mercury, nickel, silver, tin, and zinc, as well as the lighter elements aluminium, arsenic, and selenium. These elements occur naturally in many soils in different concentrations, but the most significant concern is accumulating the elements from anthropogenic sources. Based on recent literature, an adequate term for the nonorganic observed pollutants in the soil is: "potentially toxic elements" (PTEs) since they can have a natural geochemical origin and the role of nutrients, and at the same time, they can also be toxic if they are found in excessive concentration. They all have an essential role in the relationship between soil plants and animal organisms, either as nutrients or toxicants. The soil is a complex heterogeneous medium comprising mineral constituents, organic matter, living organisms, and aqueous and gaseous components [1]. It is a significant component of urban ecosystems, contributing directly or indirectly to the general quality of life of city residents. Compared to rural areas, urban areas have a higher population density, which results in more intense traffic. They are located closer to industrial plants and other sources of anthropogenic pollution [2]. As a result, the soil in urban areas is more susceptible to the adverse effects of these factors. Potentially toxic elements in urban areas are of great concern due to their nonbiodegradability, long residence time and long biological half-lives for elimination from the body. PTEs can accumulate in plants and thus enter the food chain. Humans can also be exposed to these elements in the soil more directly through inhalation, dermal contact absorption and ingestion through the mouth with dirty hands, which puts children at particular risk [3]. Based on previous surveys in Novi Sad, high concentrations of certain pollutants were detected in several urban zones, so it is essential to conduct a comprehensive analysis to assess and reduce the population's health risk. The observed soil was sampled from a depth of 0-10 cm to determine the danger of PTEs direct entering the human body via inhalation, ingestion, and dermal contact.

The economic mismanagement in the last decades has led to the decay or demise of once large industrial combines in the city of Novi Sad. It is considered that the primary pollution sources in the area studied in this work may be traffic, oil refining and combustion from home

heating in some parts of the city. The aim of the study was: (1) to determine the pseudo-total and available (in EDTA) concentrations of As, Cd, Co, Cr, Cu, Ni, Pb, Zn, and total mercury content (THg) in the soil in urban parks of Novi Sad, Serbia; (2) to estimate pollution sources; (3) to assess health risk associated with the pollutants.

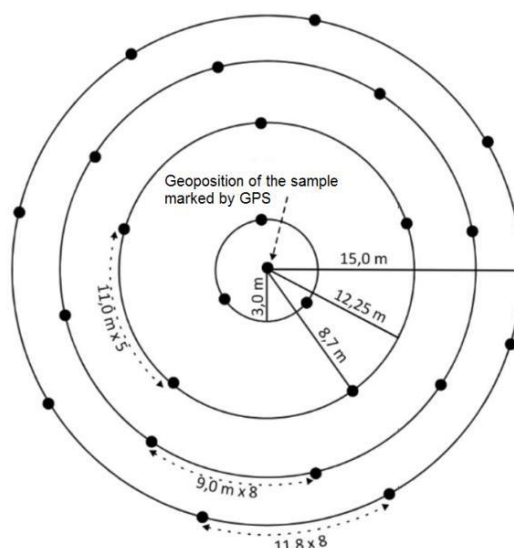
Soil pollution by potentially toxic elements is a widespread problem posing a significant risk to human health or the environment. The criteria presented in 2005 based on the average values of a large number of data for the concentration of potentially toxic elements in the soils of the Mediterranean, Central Europe, and Eurasia are shown in Table 1.

**Table 1.** The content of metals in the soils of Europe (The European Soil Database, version V2.0, EUR 19945 EN) [4]

Element mg/kg	Background - Natural Values	Slightly Higher Values	Contamination	High Contamination
As	< 29	29 – 30	30 – 50	> 50
Co	< 20	21 – 50	50 – 300	> 300
Cd	< 0.8	0.8 – 5.0	5 – 20	> 20
Cr	< 130	130 – 250	250 – 800	> 800
Cu	< 36	36 – 100	100 – 500	> 500
Ni	< 35	35 – 100	100 – 500	> 500
Pb	< 85	85 – 150	150 – 600	> 600
Zn	< 140	140 – 500	500 – 3000	> 3000
Hg	< 0.3	0.3 – 2	2 – 10	> 10

## MATERIAL AND METHODS

Ten surface soil samples (0 -10 cm) depth were collected in seven urban parks of the city of Novi Sad, according to the methodology of the reference sample (circle method). One sample represents the average value of several individual soil samples taken in concentric circles around one central point. (Figure 1). The soil samples were air-dried at room temperature and milled to a particle size of < 2 mm. All laboratory analyses were performed at the Laboratory for Soil and Agroecology of the Institute of Field and Vegetable Crops, Novi Sad, accredited according to the standard ISO/IEC 17025 (2005). Particle size distribution of the soil was determined by the internationally recognized pipette method. The size fractions were defined as coarse sand (2 – 0.2 mm), fine sand (0.2 – 0.02 mm), silt (0.02 - 0.002 mm) and clay (< 0.002 mm). The pH value in 1:5 (V/V) suspension of soil in 1 mol/L KCl was determined using a glass electrode according to ISO 10390 (2010). The carbonate content, as free CaCO<sub>3</sub> content, was determined according to the ISO 10693 (1995) volumetric method. Oxidation using the sulfochromic oxidation method specified in ISO 14235 (1998) was used to determine the amount of organic matter (OM). The samples were analyzed for pseudo-total contents of As, Cd, Co, Cr, Cu, Ni, Pb and Zn after microwave digesting the soil in concentrated HNO<sub>3</sub> and H<sub>2</sub>O<sub>2</sub> (5 HNO<sub>3</sub>:1 H<sub>2</sub>O<sub>2</sub>, and 1:12 solid: solution ratio) by stepwise heating up to 180°C using a Milestone Vario EL III for 55 min. The concentration of the elements was determined by ICP-OES (Vista Pro-Axial, Varian) by US EPA method 200.7:2001. The samples were analyzed for total mercury content using the Direct Mercury Analyzer DMA 80 Milestone, which combines techniques of thermal decomposition, catalytic conversion, amalgamation, and atomic absorption spectrophotometry ( $\lambda = 253.65$  nm) in solid soil samples. The samples were analyzed for available metal content after extraction with 0.05 mol/l EDTA (pH = 7.00). The concentrations of metals were determined by ICP-AES (Vista Pro-Axial, Varian) by US EPA method 200.7:2001.



**Fig. 1.** Circle method of sampling

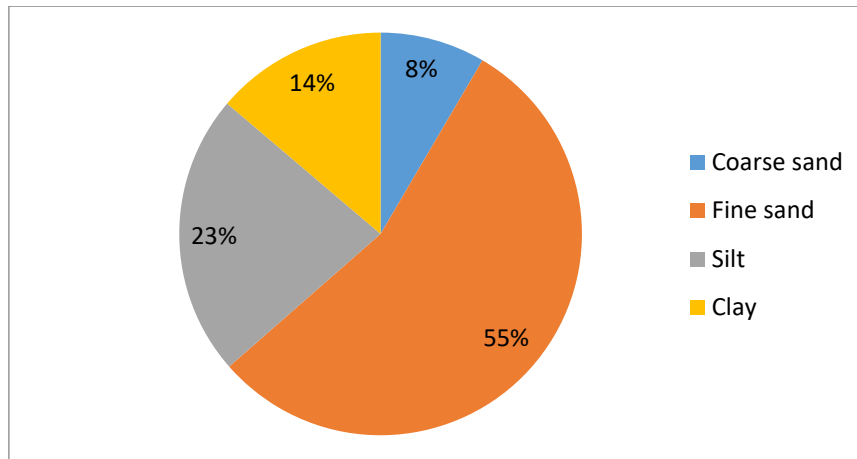
## RESULTS AND DISCUSSION

The chemical and physical characteristics of the topsoil in seven urban parks of Novi Sad are summarized in Table 2. The pH value of the soil ranged from 5.98 to 7.87, with an average value of 7.34. All samples are slightly alkaline except one, which is moderate acid (5.98). According to the content of total  $\text{CaCO}_3$ , most of the samples are found to contain high levels of  $\text{CaCO}_3$ . One-third of the samples belong to the class of medium-carbonated soils. Only one sample (the value of 0.17 %) belongs to non-calcareous soil. It is interesting to note that this sample of carbonate-free soil has an acidic pH value (5.98). The organic matter content ranged from 1.77 to 3.47, with an average value of 2.69, which means that the soils are weakly to moderately fortified with organic matter. A value greater than 3 % was recorded only for one sample. The pH value, content of  $\text{CaCO}_3$  and OM content have a significant influence on the binding and accessibility of potentially toxic elements in the soil. The soils of the study area show a sandy texture. Half of the soil samples (55.1 %) correspond to the mechanical composition of fine sand (Figure 2). The mean values of silt and clay are 22.7 % and 13.8 %, respectively. The fraction of coarse sand is the least represented, with a value of 8.45 %.

**Table 2.** Average values of main physical and chemical characteristics of the soil in urban parks

	<b>Coarse sand</b> %	<b>Fine sand</b> %	<b>Silt</b> %	<b>Clay</b> %	<b>pH (KCl)</b>	<b>Tot <math>\text{CaCO}_3</math></b> %	<b>OM</b> %
Mean	8.45	55.1	22.66	13.79	7.34	10.18	2.69
Median	7.1	53.89	21.82	13.56	7.43	11.32	2.68
Range	2.60-18.27	36.87-79.37	13.44-31.6	3.88-25.6	5.98-7.87	0.17-16.47	1.77-3.47
SD	5.7	14.71	6.06	8.28	0.53	5.34	0.46

Soil quality standards have been established in many countries to evaluate the contamination and risk assessment for PTEs in soils. The results were compared with the values given by Serbian Official Gazette: Regulation on limit values of polluting, harmful and dangerous substances in soil [5].



**Fig. 2.** Particle size distribution in the soil

The pseudo-total amount of potentially toxic elements in the soils of seven urban parks in Novi Sad and some basic statistical parameters are presented in Table 3. The available content of PTEs is shown in Table 4. The maximum value of arsenic concentration was 8.21 mg/kg (Table 3), and none of the tested soil samples exceeded the target value (29 mg/kg). Based on the criteria listed in Table 1, the arsenic content in this research is at the level of background concentrations in Europe. Stajic et al. [6] reported similar results for arsenic concentration in soils of urban parks in Kragujevac. Cadmium was not detected in this study (the detection limit was 1.5 mg/kg), as in the research of Pavlovic et al. carried out for soils in urban parks in four cities in Serbia [7]. The median value obtained for Co was about 6 mg/kg, corresponding to the average background concentration level in Europe. The cobalt concentration was close to the limit value only for one sample (9.1 mg/kg) in Kamenički Park, located on Fruška Gora's slopes. Gulan et al. [8] reported exceeded content of Co and Ni (comparing to the limit values) for locations in urban parks in Belgrade and remnant forest in its surroundings. The values for pseudo-total chromium content range from 15.45 to 61.24 mg/kg, and none of the tested samples has a higher concentration than LV (100 mg/kg). The available content of Cr (in EDTA) was not detected in any sample, i.e. it was below the detection limit (0.5 mg/kg) of the applied analytical method. One sample in Dunavski park in total content (44.9 mg/kg) exceeds the prescribed limit value for copper (36 mg/kg). In this locality, the concentration of Cu is elevated, but significantly lower than the remediation value of 190 mg/kg (Table 3). The available ratio of copper ( $AR = Cu_{EDTA}/Cu_{TOT}$ ) in all locations is high (about 30 %), which can suggest anthropogenic pollution. Values for nickel content vary from 13.34 to 50.45 mg/kg (LV is 35 mg/kg). At one location, the concentration of 50.4 mg/kg is above the limit value for Ni (35 mg/kg), but the value is four-times lower than the remediation value (210 mg/kg) given by regulations. A similar result was obtained in the research within the project "Program for monitoring the quality of agricultural and non-agricultural land in the territory of the city of Novi Sad" in the period from 2006 to 2008 [9] when the elevated nickel concentration of 84 mg/kg was measured at the same location. This indicates the geochemical origin of nickel in Kamenički park because the soils of Fruška Gora have naturally elevated nickel content as a result of the parent material on which the soil was formed. The available Ni content of this sample is low (2.1 mg/kg) with an available ratio of  $Ni_{EDTA}/Ni_{TOT} = 0.042$ , which also confirms its natural origin. Lead (Pb) is one of the most common pollutants in urban areas. Mihailovic et al. [10] obtained 300 mg/kg for the mean value of pseudo total Pb content in roadside soils in Novi Sad. Vidojevic et al. [9] reported a range of 19.0 - 47.4 mg/kg. According to this study, the determined lead concentrations are at the background level for European soils (Table 1), probably because all locations were not near roads with intense traffic. The available content is relatively low, at the level where there is no risk of phytotoxicity. However, the available ratio for lead is relatively high (about 50%), which, as for Cu, implies the anthropogenic origin of Pb in the soils of urban parks in Novi Sad. The values of the total mercury content in this research vary

in the interval from 0.03 mg/kg to 0.18 mg/kg, and the result is most often cited for mercury content in soil without a known close source of pollution, which amounts to 0.01-1 mg/kg. The median value obtained for Zn is (72.97 mg/kg), which is about two times lower than the limit value for this element.

**Table 3.** Statistical description of pseudo-total PTEs content and total mercury content (THg) in the soil of urban parks

[mg/kg]	As	Co	Cr	Cu	Ni	Pb	Zn	THg
Mean	6.82	6.28	27.5	26.21	23.69	17.02	73.63	0.1
Median	7.13	6.16	23.33	24.69	21.2	15.3	72.97	0.09
Range	4.52- 8.21	3.98- 9.11	15.45- 61.24	16.96- 44.86	13.34- 50.45	10.72- 30.70	38.21- 123.1	0.03- 0.18
SD	1.18	1.77	13.66	8.21	10.54	5.53	25.23	0.06
LV	29	9	100	36	35	85	140	0.3
RV	55	240	380	190	210	530	720	10

SD – Stanard Deviation

LV – Limit Values [5]

RV – Remedation Values [5]

**Table 4.** Statistics of available (in EDTA) PTEs content in the soil of urban parks

[mg/kg]	As	Co	Cr	Cu	Ni	Pb	Zn
Mean	0.71	0.66	<MDL (0.5)	8.16	2.02	11.28	11.40
Median	0.68	0.25		8.84	1.36	9.86	6.73
Range	0.25- 1.60	0.25- 3.32		1.49- 11.36	0.42- 6.36	2.18- 24.69	3.54- 44.57
SD	0.43	0.99		2.75.	1.83	6.67	12.45

## CONCLUSION

The pseudo-total and available concentrations of potentially toxic elements (As, Cd, Co, Cr, Cu, Ni, Pb, Zn and Hg) in the topsoil of seven urban parks in Novi Sad were determined using the ICP-OES technique and Direct Mercury Analyzer. Based on the content of toxic elements in relation to the criteria outlined in the Regulation on limit values of polluting, harmful and dangerous substances in soil in Serbia, none of the ten examined soil samples in the parks exceeded the limit values for arsenic (As), cobalt (Co), chromium (Cr), lead (Pb), zinc (Zn), and mercury (Hg). However, two soil samples, one from Dunavski park (for Cu) and one from Kamenički park (for Ni), exceeded the limit values. Maximum values for the available ratio for Pb and Cu were obtained, suggesting their anthropogenic origin. In general, the content of toxic elements in the city park soils falls within the permitted limits. Nonetheless, higher levels of certain harmful elements were detected in two locations, highlighting the need for ongoing research on soil quality in city parks.

## ACKNOWLEDGEMENTS

This research has been supported by the Ministry of Education, Science and Technological Development through the project no. 451-03-68/2020-14/200156: "Innovative scientific and artistic research from the FTS activity domain".

## REFERENCES

- [1] Alloway, B.J. and Ayres, D.C., Chemical Principles of Environmental Pollution, 2nd ed. Blackie Academic and Professional, 1997.

- [2] Long, Z., Huang, Y., Zhang, W., Shi, Z., Yu, D., Chen, Y., Liu, C., and Wang, R., Effect of different industrial activities on soil heavy metal pollution, ecological risk, and health risk, *Environmental Monitoring and Assessment*, Vol.193(1), 2021.
- [3] Abrahams, P.W., Soils: Their implications to human health', *Science of the Total Environment*, Vol. 291, pp. 1-32, 2002.
- [4] Houskova, B., Montanarella, L., Parent material as a source of natural background values in soils. European Commission-Joint Research Centre, 2005.
- [5] "Official Gazette of RS", No. 30/2018 i 64/2019, 2019.
- [6] Stajic, J.M., Milenkovic, B., Pucarevic, M., Stojic, N., Vasiljevic, I., Nikezic.D., Exposure of school children to polycyclic aromatic hydrocarbons, heavy metals and radionuclides in the urban soil of Kragujevac city, Central Serbia, *Chemosphere*, Vol. 146, pp. 68-74, 2016.
- [7] Pavlović, D., Pavlović, M., Čakmak, D. et al., Fractionation, Mobility, and Contamination Assessment of Potentially Toxic Metals in Urban Soils in Four Industrial Serbian Cities. *Archives of Environmental Contamination and Toxicology* Vol. 75, pp. 335–350, 2018.
- [8] Gulan, L., Stajic, J. M., Zeremski, T., Durlević, U., Valjarević, A., Radionuclides and Metals in the Parks of the City of Belgrade, Serbia: Spatial Distribution and Health Risk Assessment. *Forests*, Vol. 13(10), pp.1648, 2022.
- [9] Vidojević, D., Izveštaj o stanju zemljišta u republici Srbiji, 2009. Ministarstvo životne sredine i prostornog planiranja Republike Srbije, Beograd, 2009.
- [10] Mihailović, A., Budinski-Petković, L., Popov, S., Ninkov, J., Vasin, J., Ralević, N. M., & Vasić, M. V., Spatial distribution of metals in urban soil of Novi Sad, Serbia: GIS based approach. *Journal of Geochemical Exploration*, Vol. 150, pp. 104-114, 2015.



## LANDFILLS MEET PLASTICIZERS: TRADITIONAL, NOVEL AND SUBSTITUTIONS AND THEIR IMPACT ON THE ENVIRONMENT AND HUMAN HEALTH

**Tijana Adamov<sup>1</sup>, Ivan Španik<sup>2</sup>, Nemanja Koljančić<sup>2</sup>, Maja Petrović<sup>1</sup>**

<sup>1</sup>University of Novi Sad, Faculty of Technical Sciences, Department of Environmental Engineering and Occupational Safety and Health, Trg Dositeja Obradovića 6, Novi Sad 21000, Serbia, e-mail: [tijana.adamov.tiki@gmail.com](mailto:tijana.adamov.tiki@gmail.com)

<sup>2</sup>Slovak University of Technology, Faculty of Chemical and Food Technology, Institute of Analytical Chemistry, Radlinskeho 9, SK-812 37 Bratislava, Slovakia

**Abstract:** An integrated waste management system (IWMS) combines waste streams, waste collection, treatment and disposal methods. One part of the IWMS system are municipal solid waste (MSW) landfills, which receive household waste, other types of nonhazardous wastes, such as commercial solid waste, nonhazardous sludge and industrial nonhazardous solid waste. However, improper disposal may result in leaching of hazardous pollutants, as well as airborne hazards, which can then negatively impact the environment and have adverse effects on human health. The conducted research experiment was focused on plasticizers present in landfill leachate of Serbian municipal solid waste landfills. For this a gas chromatographic-mass spectrometric analysis was performed. Samples were prepared by liquid-liquid extraction. Plasticizers are by far the most common additives. They are also less expensive than other additives used in polymers processing and applications. Predicting the environmental fate and movement of plasticizers is currently hampered by a lack of information. The presented results highlight the presence of 17 plasticizers identified in landfill leachate and should prompt future assessments of their environmental risks and impacts, as well as human health risks.

**Keywords:** plasticizers, fire-retardants, bisphenols, municipal solid waste, landfill leachate

### INTRODUCTION

An Integrated Waste Management System (IWMS) represents a holistic approach to managing waste, encompassing the coordination of various waste streams, collection, treatment, and disposal methods. Within the framework of an IWMS, municipal solid waste (MSW) landfills constitute a crucial component. These landfills serve as repositories for a wide spectrum of waste types, including household waste, commercial solid waste, nonhazardous sludge, and industrial nonhazardous solid waste. Modern landfills are well-engineered and managed facilities for the disposal of solid waste. Their location, design, way of operating, as well as required environmental monitoring, are all serving the purpose of ensuring compliance with national regulations and international directives. They are also designed to protect the environment from contaminants, which may be present in the waste stream [6].

In the past century, engineering plastics have progressed from being a novel invention to becoming a major component in numerous industries. The global plasticizers market is expected to reach \$111 billion by 2023. Both technically and economically, plastic additives form a large and increasingly significant part of the polymer industry. Plasticizers account for about one third of the global plastic additives market in terms of consumption. They are chemical additives used to increase structural flexibility, yet have recently been scrutinized for environmental and health related problems. The expansion of plasticizing compounds to meet new material challenges, has also led to significant technical advances [9].



A multitude of applications for plasticizers are propelled by a wide array of expectations centered on enhancing the inherent properties of polymers and the final products into which these polymers are incorporated through the utilization of plasticizers [12]. Some of the most important expectations from plasticizers are:

- decreasing the glass transition temperature of polymer;
- making the material more flexible;
- increasing elongation and decreasing tensile strength;
- decreasing in ductility of materials and improvement of their impact resistance;
- low-temperature properties of many materials are improved by different types and concentrations of plasticizers;
- viscosity control and improvement in the workability of complex industrial formulations;
- lower melting temperatures and lower degradation rate;
- effect on electric conductivity depends on the electric properties of plasticizers, which may act as additional conductors or insulators;
- fire behavior – most plasticizers generally increase the susceptibility of the material to burn, drip during burning and produce smoke but some plasticizers (phosphates and chloroparaffins) reduce burnability of materials and smoke production;
- resistance to biological degradation or in biodegradable materials, selected plasticizers are deliberately added to increase the biodegradation rate;
- improvement of sound blocking and vibration damping properties;
- improvement of optical clarity by homogenizing system components.

### **Classification of plasticizers**

Plasticizers continue to evolve with the demand of specialty applications, whereas in recent years more frequently research has been conducted regarding the safety of many traditional plasticizers, mainly hydrocarbons, which often make the polymers more susceptible to fire hazards. This led to the emergence of novel plasticizers including citric acid esters, oligomers and polymeric plasticizers, PVC/EVA (ethylene vinyl acetate) graft polymers and terpolymers, epoxidized soybean oil, many of which have become commercially available over the past two decades [9].

Plasticizers are typically categorized according to their chemical composition. This approach facilitates a clearer comprehension of how the structural components of plasticizers impact their properties and, subsequently, their influence on the materials in which they are employed. For this reason, they are also grouped by chemical family (or category) such as esters, phthalates, chlorinated paraffins [12]. A few categories will be covered in this research paper, mainly the ones of interest that have been identified in the samples. The groups are as follows:

- Phthalates - there are three isomeric forms of phthalic acids and as many phthalates (phthalates, isophthalates, terephthalates). Until now, phthalates, such as di-2-ethylhexyl phthalate (DEHP), also known as dioctyl phthalate (DOP), are still the most used commercial polyvinyl chloride (PVC) plasticizer, occupying over 70% of the market [14]. Phthalates are used in the manufacturing of diverse products such as artificial leather upholstery for cars and homes, medical devices, shower curtains, vinyl tiles, clothing such as raincoats and footwear, cosmetics, food packaging, and children's toys;
- Phenols - specifically phenolic resins. Bisphenol A (BPA or 4,4'-(propane-2,2-diyl)diphenol) is a synthetic chemical that has been used in a variety of industrial applications dedicated to the production of polycarbonate plastics, epoxy resins, other polymers and thermal papers. Another noteworthy application of this chemical

lies in its role as a stabilizer during the PVC production process. In industrial applications, the predominant substituents often utilized include bisphenol S (BPS; 4,4'-sulfonylbisphenol) and bisphenol F (BPF; 4,4'-dihydroxydiphenyl-methane) [3, 11];

- Sulfonamides - sulfonamide plasticizers have unusually high solubility parameters. They are not compatible with PVC. However, they have found successful applications in the manufacturing of non-fogging automotive adhesives based on polyurethane and ethylene-vinyl acetate copolymers.;
- Phosphates - aryl, alkyl, and mixed esters of phosphoric acid are used as plasticizers. Aryl esters are preferred as flame-retarding components of the formulation. Aryl plasticizers have low volatility and good extraction resistance, but they decrease low-temperature flexibility. Alkyl phosphates are good low-temperature plasticizers but less effective as flame-retarding additives [12].

Additional two classifications, referred to as novel plasticizers, are bioplasticizers and biodegradable plasticizers. Even though, they were not identified in the samples, as the above mentioned four categories have, it is important to mention the new inventions where plastics are headed [12].

## ENVIRONMENTAL FATE

Plasticizers are released into the environment during their production, distribution, and application in making plastic products, waste disposal, and during the use of the finished product by the consumer. Plasticizers are not classified as Priority Pollutants, and hence there are no mandatory tracking requirements. Not all chemical companies are required to report to the United States Environmental Protection Agency (U.S. EPA).

A paramount property of a plasticizer in the environment is its solubility in water. The greater its aqueous solubility, the more likely it will dissolve into water, and become part of the hydrologic cycle. Water solubility affects the extent of leaching of plastic products, and the movement and chemical fate of dissolved plasticizers in rivers, lakes and groundwater. Many plasticizers have a water solubility that is less than 1 mg/L [12]. Thus, plasticizers can persist in the environment for longer periods, and pose ecological health risks [7]. Plasticizers are estimated to yield half-lives of one to 56 days in surface waters, and in groundwater from less than one day to about one year. Some research shows that plasticizers have been detected in surface water at concentrations ranging from 0,002 to 86 µg/L, and in groundwater samples at concentrations of 8 ng/L to 200 µg/L [12].

Plasticizers dissolved in water may partition or volatilize into the atmosphere or into soil gases. Many appear to have a small potential (less than  $10^{-4}$  atm-m<sup>3</sup>/mole) for volatilization and it appears to be a relatively slow process. The actual rate of volatilization of plasticizers from water apparently has not been experimentally measured, so it is uncertain if it is a significant environmental pathway.

The disappearance of a plasticizer from water can be the result of a number of abiotic and biotic processes that can transform or degrade the compound into daughter compounds that have different physicochemical properties from the parent compound. The persistence of plasticizers especially phthalates is linked to their absorption and bioaccumulation by soil organisms [7]. Reported literature rates and extents of biodegradation of contaminants depend on the experimental conditions and may not be applicable to other scenarios. Most often results were derived from aerobic waste-water treatment facilities that have been optimized in terms of nutrient content, microbial acclimation, mechanical mixing of the reactants, and temperature. Hence, the results of such studies may under-predict their persistence in leachate and groundwater [12].

## HEALTH AND SAFETY ISSUES

Adverse health effects have been confirmed in various research studies conducted on plasticizers. As a few categories are covered in this research paper, only their effects on human health will be reported.

**Phthalates** – Robust evidence put forward an association between phthalates/metabolites and lower semen quality, neurodevelopment and risk of childhood asthma, and moderate to robust evidence for impact on anogenital distance in boys. Furthermore, moderate evidence exists for an association between phthalates/metabolites and low birthweight, endometriosis, decreased testosterone, Attention Deficit Hyperactivity Disorder (ADHD), Type 2 diabetes and breast/uterine cancer. The severity of the effects differs depending on the type of chemical, dose, route of administration, timing of exposure, and species tested [5, 12].

**Phenols** – Human exposure to BPA is widespread in the general population and has been potentially linked to a variety of adverse health outcomes on the reproductive system, metabolic processes (obesity, metabolic dysfunctions and diabetes), the immune system and cognitive and behavioral development [4]. Many of the predominant BPA-associated behavioral outcomes are common endophenotypes of neurodevelopmental disorders, such as: ADHD, Autism Spectrum Disorder (ASD), Identity Disorder (ID), increased locomotor activity (hyperactivity), deficits in learning and memory and increased anxiety-like behavior. Regulations for reducing the usage of BPA have resulted in an increasing replacement with other bisphenols that might possess similar toxicological properties.

**Sulfonamides** – The general toxicity data indicate that N-ethyl-toluenesulfonamide (NETSA, Uniplex 108) induces acute transient effects on the central nervous system, such as lethargy and uncoordinated movements. Increased absolute and relative weights of liver and kidneys, indicate liver and kidney toxicity. Further studies are therefore needed to clarify the mutagenic and genotoxic potential of NETSA [8]. N-Butylbenzenesulfonamide (Uniplex 214) shows decrease in body weight and an increase in mortality. Some studies show that it is overly toxic with a potentially steep dose-response relationship. Correspondingly, adverse effects on male reproductive tissues (i.e., histopathological changes in testes and epididymides) were noted [10].

**Phosphates** – According to the categories established by the United Nations, 2-Propanol, 1-chloro-, phosphate (3:1) (TCPP) can be considered as highly toxic to marine species. These findings suggest that the wide utilization of TCPP and its consequent release into the environment could have adverse effects on aquatic organisms and humans [1]. The second identified plasticizer from this group, Phosphonic acid, ethyl-, diethyl ester (DEEP), has not been investigated in long-term animal experiments for tumorigenicity. However, based on current available research data it may be expected that this compound induces renal tumor formation given at high doses for a prolonged time [2]. The identified organophosphate flame retardants (triethyl phosphate and triisopropyl phosphate) have a potential for endocrine disruption. Notably, they may lead to pathological changes in organisms by inhibiting enzyme activity, producing developmental neurotoxicity, and disrupting sex hormones and the immune system [13].

## MATERIALS AND METHODS

Leachate sampling was conducted at five MSW landfills (three in urban and two in sub-urban areas, with agricultural background) in Republic of Serbia. There were a total of three sampling campaigns, amounting to 18 collected samples. Prior to every sampling, 2,5 L brown glass bottles have been cleaned with diluted nitric acid and rinsed several times with Milli-Q water, then dried overnight in the oven. Throughout the whole procedure no plastic bottles or plastic laboratory equipment was used to avoid contamination. Samples were prepared by liquid-liquid extraction with dichloromethane, evaporated to 1 ml and analyzed by gas chromatography-mass spectrometry. All steps in sample preparation were done under a fume hood.

## RESULTS AND DISCUSSION

Based on the laboratory analyses, at the current research stage, the presence of several plasticizers in the leachate samples was determined. Table 1 shows the plasticizers, as well as the number of landfill sites each was identified on.

*Table 1. Identified plasticizers on five MSW landfill sites in Serbia*

Identified plasticizer	CAS number	Group of plasticizers	Number of MSW landfills with identified plasticizer
2-Propanol, 1-chloro-, phosphate (3:1) (TCPP)	13674-84-5	Phosphates	4
Phosphonic acid, ethyl-, diethyl ester (DEEP)	78-38-6	Phosphates	1
Triethyl phosphate (TEP)	78-40-0	Phosphates	2
Triisopropyl phosphate (TiPP)	513-02-0	Phosphates	3
Bis(2-ethylhexyl) isophthalate (DEHP)	137-89-3	Phthalates	4
Bis(2-ethylhexyl) phthalate (DEHP)	117-81-7	Phthalates	3
N-ethyl-toluenesulfonamide (Uniplex 108)	1077-56-1	Sulfonamides	2
N-Butylbenzenesulfonamide (Uniplex 214)	3622-84-2	Sulfonamides	3
1,2-Benzenedicarboxylic acid, butyl octyl ester	84-78-6	Phthalates	2
Bisphenol A (BPA)	80-05-7	Phenols	5
Diethyl isophthalate (DOIP)	137-89-3	Phthalates	2
Diethyl terephthalate (DOTP)	6422-86-2	Phthalates	4
Didecan-2-yl phthalate	28029-89-2	Phthalates	5
Diethyl phthalate (DEP)	84-66-2	Phthalates	2
Didecyl phthalate	84-77-5	Phthalates	3
Dibutyl phthalate (DBP)	84-74-2	Phthalates	4
Didodecyl phthalate	2432-90-8	Phthalates	1

The presence of 17 different plasticizers in landfill leachate, with varying occurrences across different municipal solid waste (MSW) landfill sites, can be attributed to several factors, including their widespread use in various products, their chemical properties, and the specific waste materials deposited in these landfills. Many of the identified plasticizers, such as BPA, DEHP and DBP, are commonly used in a wide range of consumer products, including plastics, cosmetics, and packaging materials. These products can end up in landfills when discarded, leading to the presence of these plasticizers in landfill leachate. The presence of plasticizers like DOTP and DEHP on multiple landfill sites suggests that industrial and commercial waste, which often contains materials with these plasticizers, may be a significant source. Plastic materials themselves can contain plasticizers to enhance flexibility and durability. Over time, these plasticizers can leach from the plastic products, especially in the anaerobic conditions of a landfill, and contaminate the leachate. The persistence of certain plasticizers, like didecan-2-yl phthalate, in landfill leachate could be due to their chemical properties, which make them resistant to degradation. These plasticizers can persist in the environment for extended periods. The movement of plasticizers through soil and groundwater, especially in areas with poor landfill liner systems or near the landfill's boundaries, can lead to their presence in leachate. The presence of specific plasticizers on certain landfill sites might also be influenced by local waste management practices, the types of waste accepted at those sites, and the effectiveness of containment and mitigation

measures. Chemical interactions between different waste components in landfills can also influence the presence and distribution of plasticizers in leachate.

## CONCLUSION

The presence of a diverse range of plasticizers in landfill leachate highlights the complex and persistent nature of these compounds in the environment. Plasticizers are ubiquitous in various consumer products, and their occurrence in landfill leachate is a reflection of the widespread use of plastics and plasticized materials in our daily lives. The findings from this research study underscore the importance of monitoring and understanding the environmental fate of plasticizers, especially in the context of integrated waste management systems.

Several factors contribute to the presence of plasticizers in landfill leachate, including the types of waste materials deposited in landfills, industrial and commercial waste streams, and the inherent properties of certain plasticizers that make them resistant to degradation. The movement of these compounds through soil and groundwater can lead to potential contamination of surrounding ecosystems, emphasizing the need for effective containment and mitigation measures in landfill design and management. Future research should focus on the long-term fate and transport of plasticizers in landfill environments. This includes investigating the persistence and transformation of specific plasticizers over extended periods and under different environmental conditions. A more detailed characterization of the waste streams entering landfills is essential. This can help identify the sources and prevalence of specific plasticizers in different landfill sites. Further studies should assess the potential health and ecological impacts of plasticizer contamination in the environment. This includes evaluating the effects of low-level exposure to plasticizers on human health and wildlife, as well as assessing the risks associated with the persistence of these compounds in ecosystems. Establishing standardized monitoring protocols for plasticizers in landfill leachate and surface waters is essential. This would enable ongoing assessment of plasticizer concentrations and trends, aiding in the development of evidence-based policies and regulations.

## ACKNOWLEDGMENT

Authors extend appreciation to the Ministry of Education, Science and Technological Development through the Bilateral project "Microplastics impact on occurrence of plasticizers in surfacewater and effects on human health – PLASTICINE" and the project no. 451-03-47/2023-01/200156: "Innovative scientific and artistic research from the FTS (activity) domain" as well as to Slovak Research and Development Agency by grant APVV-21-0178.

## REFERENCES

- [1] Antonopoulou, M., Vlastos, D., Dormousoglou, M., Bouras, S., Varela-Athanasatou, M., Bekakou, I.-E. Genotoxic and Toxic Effects of The Flame Retardant Tris(Chloropropyl) Phosphate (TCPP) in Human Lymphocytes, Microalgae and Bacteria. *Toxics* 2022, 10, 736, 2022.
- [2] Blumbach, K., Pähler, A., Deger, H., Dekant, W., Biotransformation and Male Rat-Specific Renal Toxicity of Diethyl Ethyl- and Dimethyl Methylphosphonate, *Toxicological Sciences* 53, pp: 24 – 32, 2000.
- [3] Bousoumah, R., Leso, V., Iavicoli, I., Huuskonen, P., Viegas, S., Porras, S.P., Santonen, T., Frery, N., Robert, A., Ndaw, S., Biomonitoring of occupational exposure to bisphenol A, bisphenol S and bisphenol F: A systematic review, *Science of the Total Environment* 783, 146905, 2021.
- [4] Cimmino, I., Fiory, F., Perruolo, G., Miele, C., Beguinot, F., Formisano, P., Oriente, F., Potential mechanisms of bisphenol A (BPA) contributing to human disease, *International Journal of Molecular Sciences* 21 (16), 5761, 2020.

- [5] Eales, J., Bethel, A., Galloway, T., Hopkinson, P., Morrissey, K., Short, RE., Garside, R., Human health impacts of exposure to phthalate plasticizers: An overview of reviews, *Environment International* 158, 106903, 2022.
- [6] Environmental Protection Agency, Basic information about landfills, Available at <https://www.epa.gov/landfills/basic-information-about-landfills>.
- [7] Gwenzi, W., *Emerging Contaminants in the Terrestrial-Aquatic-Atmosphere Continuum: Occurrence, Health Risks and Mitigation*. Elsevier, 2022.
- [8] Norwegian Scientific Committee for Food Safety, Risk assessment of N-ethyl-toluenesulfonamide (NETSA) used as plasticizer in printing inks on food packaging materials, VKM Report 2008: 11. 2008.
- [9] Rahman, M., Brazel, C., The plasticizer market: an assessment of traditional plasticizers and research trends to meet new challenges, *Progress in Polymer Science* 29, pp: 1223 – 1248, 2004.
- [10] Rider, C., Vallant, M., Blystone, C., Waidyanatha, S., South, N., Xie, G., Turner K., Short-term perinatal toxicity study in sprague Dawley rats with the plasticizer and emerging contaminant N-Butylbenzenesulfonamide, *Toxicology Letters* 330, pp: 159 – 166, 2020.
- [11] Rochester, J., Bolden, A., Bisphenol S and F: A Systematic Review and Comparison of the Hormonal Activity of Bisphenol A Substitutes, *Environmental Health Perspectives*, Volume 123, Number 7, July 2015.
- [12] Wypych, G., *Handbook of plasticizers*, 4<sup>th</sup> Edition, ChemTec Publishing, Toronto, Canada, 2023.
- [13] Yao, C., Yang, H., Li, Y., A review on organophosphate flame retardants in the environment: Occurrence, accumulation, metabolism and toxicity, *Science of the Total Environment* 795, 148837, 2021.
- [14] Zhang, Z., Jiang, P., Liu, D., Feng, S., Zhang, P., Wang, Y., Fu, J., Agus, H., Research progress of novel bio-based plasticizers and their applications in poly(vinyl chloride), *Journal of Materials Science* 56, pp: 10155 – 10182, 2021.



## FRESH HYPERALKALINE GROUNDWATERS CONTAIN POLYURETHANE-DEGRADING *FLAVOBACTERIUM*

Vladimir Šaraba<sup>1</sup>, Jasmina Nikodinovic-Runic<sup>1</sup>, Milica Ciric<sup>1</sup>

<sup>1</sup>University of Belgrade, Institute of Molecular Genetics and Genetic Engineering,  
Belgrade, Serbia

e-mail: [vsaraba@imgge.bg.ac.rs](mailto:vsaraba@imgge.bg.ac.rs)

**Abstract:** The examined groundwaters, originating from the fractured type of aquifer formed by Pre-Middle Jurassic ultramafic rocks, i. e. harzburgites, dunites, lherzolites and serpentinites, belong to the fresh hyperalkaline cold groundwaters of OH, Cl – Ca, Na + K genetic type. Studied occurrence was characterized by the presence of aerobic cultivable bacteria with ability to grow in a pH range of 7-12. Bacterial isolates were screened using plastic, cellulosic and hemicellulosic polymeric substrates as predominant carbon source to assess their biotechnological potential. All 16 screened isolates (100%) demonstrated growth and/or activity on at least one tested substrate. One isolate belonging to genus *Flavobacterium*, produced prominent zone of clearing on Impranil® DLN-SD, a model substrate for polyurethanes (PU). Plastic-degrading potential has been previously documented for members of genus *Flavobacterium*. However, this is the first report of their PU-degrading activity. Accumulation of PU in the environment is of special concern, due to its toxicity, high production rates and lack of efficient recycling strategies. In the future, biotechnological potential of alkalophilic bacteria from groundwater environments should be explored more intensely, especially from the aspect of their application in the management of plastic waste and bioremediation treatments of plastic-polluted groundwater resources.

**Key words:** fresh hyperalkaline groundwaters, 16S rDNA sequencing, polyurethane-degrading *Flavobacterium*

### INTRODUCTION

Terrestrial subsurface contains the largest reservoir of fresh water on the Earth and about 2.5 billion people worldwide depend exclusively on groundwater resources [1]. Hyperalkaline groundwaters (HAGW), with a pH value above 11.0 [2], are globally extremely rare and are only recorded in several localities worldwide so far [3, 4]. Their zones of discharge, on the territory of Serbia, are within the framework of peridotite rocks [2]. The investigated HAGW occurrence (43.793721 N, 19.527435 E) originated below the local erosion base from the fractured type of aquifer formed by Pre-Middle Jurassic ultramafic rocks [3], i. e. harzburgites, dunites, lherzolites and serpentinites of Zlatibor massif [5], which belong to central Dinarid Ophiolitic Belt terrane [4]. The point of emergence of the studied HAGW is ascendant from the zone of large faults, fault zones and cracks, as a result of free gasses (such as CH<sub>4</sub>, N<sub>2</sub>, H<sub>2</sub> and O<sub>2</sub>) and hydrostatic pressures. Based on the values of total dissolved solids (380 mg/L), pH (11.5) and temperature (17.9°C), the examined HAGW belong to the fresh hyperalkaline cold groundwaters of OH, Cl – Ca, Na + K genetic type [3], which are captured by a dug well "Sveti Jovan Krstitelj" in the Kamišna River valley.

The genesis of HAGW is, in general, linked with the exothermic processes of serpentization [6] and contemporary serpentization processes in the area of investigated HAGW take place through the metamorphosis of primary anhydrous minerals (olive and pyroxene: diopside and enstatite) in the presence of water [3]. These geochemical processes provide a potential source of organic carbon for alkaliphiles [6], which represent a group of biotechnologically significant bacteria [7] that thrive at pH values above 9 [8]. Bacterial diversity of non-saline alkaline environments is not yet well documented, considering that these habitats are much rarer compared to saline alkaline habitats [6] and HAGW are characterized by less rich and diverse bacterial communities than those inhabited by waters with circumneutral pH values [9]. These habitats, as well as subterranean/groundwater



ecosystems in general, are rarely accessible to study and represent still largely unexplored resource of useful, stable enzymes [7] with biotechnological potential [10].

As a result of the growing global plastics production, estimated at 390.7 million metric tons in 2021 [11] and expected to double over the next 20 years [12] and its inefficient end-of-life management, with millions of tons accumulating in the environment annually [13], plastic waste has become one of major environmental burdens. Plastic particles, so called micro- and nano-plastics are also widespread in groundwater environments. Identification of novel plastic-degrading bacteria and enzymes from unexplored resources, such as subterranean ecosystems, is of fundamental importance for a circular plastic economy [14]. For this reason, the plastic-degrading potential of HAGW isolates was tested on several plastic polymers. In addition, their role in the degradation of one cellulosic and one hemicellulosic substrates was also examined, as there is a documented overlap in enzymatic activity on biomass and some of the plastic synthetic polymers [15, 16].

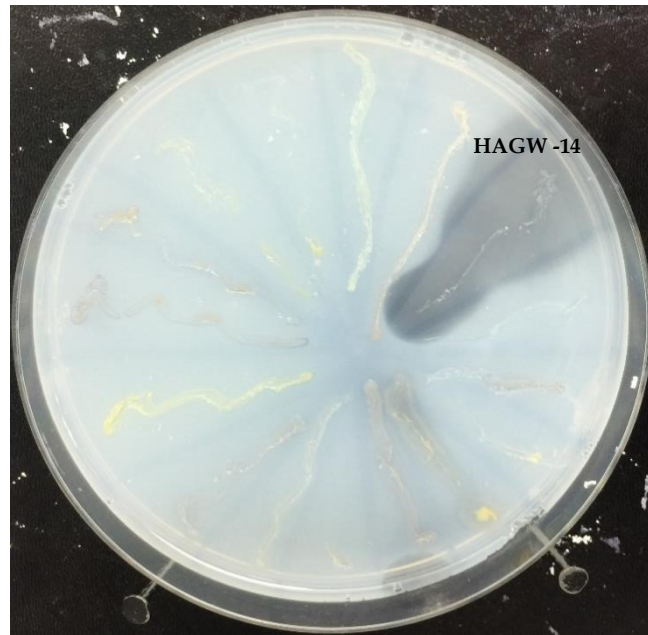
## MATERIAL AND METHODS

The examined HAGW occurrence was sampled in September 2022 and both direct groundwater sample and pellet obtained from groundwater sample were cultivated on different solid media: Horikoshi-I [17] with pH = 12 and 3 media with pH in a 7-7.2 range: Luria Agar (LA), Yeast Extract-Malt Extract (ISP-2) and Mannitol-Soy Flour (MSF) at room temperature for 96 h. Cultivated isolates representative of distinct observed morphologies were screened for growth and/or enzymatic activity using plastic, cellulosic and hemicellulosic polymeric substrates as C source to assess their biotechnological potential. The Minimal Salt Medium (15 g/L agar, 9 g/L Na<sub>2</sub>HPO<sub>4</sub> x 12 H<sub>2</sub>O, 1.5 g/L KH<sub>2</sub>PO<sub>4</sub>, 1 g/L NH<sub>4</sub>Cl, 0.2 g/L MgSO<sub>4</sub> x 7H<sub>2</sub>O, 0.2 g/L CaCl<sub>2</sub> x 2H<sub>2</sub>O, 0.1% trace elements solution and 0.025% N-Z amine) agar was supplemented with different plastic polymers: 6 g/L Impranil® DLN-SD (IMP-SD), 9 g/L Impranil® DL 2077 (IMP-DL), model substrates for polyurethanes (PU) and 6 g/L polycaprolactone diol (PCL), a model for polyester-based biodegradable plastics, as well as with 0.5% (w/v) carboxymethyl cellulose (CMC) and arabinoxylan (AXYL) and screened isolates were incubated for 4-8 weeks at room temperature. Solid media used for functional screening had a pH in a 7-7.4 range. Zones of clearance, suggesting substrate degradation is taking place, were visualized directly for plastic substrates and upon staining with 0.1% (w/v) Congo red for CMC and AXYL. Screened isolates with confirmed degrading activity on tested substrates were identified on genus level using 16S rDNA sequencing.

## RESULTS AND DISCUSSION

The examined occurrence was characterized by the presence of aerobic cultivable bacteria with ability to grow at pH 7-12. Plate counts were in the range of 4-110 CFU/mL, which is at the lower end of the range documented for groundwaters, i. e. 10<sup>2</sup> – 10<sup>8</sup> CFU/mL [18]. This was expected, taking into account that alkaliphilic bacteria that can survive in versatile pH conditions are rare [19] and that strict anaerobic communities prevail in the bacterial flora of HAGW [9]. Pigmented colonies with glistening circular appearance were predominant on all solid media.

In total, 16 HAGW isolates were screened for growth and/or enzymatic activity on plastic, cellulosic and hemicellulosic polymeric substrates. All isolates (100%) demonstrated growth and/or activity on at least one tested polymeric substrate and 1 isolate (6.25%), belonging to genus *Flavobacterium*, had the ability to degrade IMP-SD substrate, as shown in Fig. 1. Thirteen isolates in total had the ability to grow on IMP-SD substrate, while 2 and 10 isolates had the ability to grow on IMP-DL and PCL substrates, respectively. Seven isolates were capable to use CMC and 12 isolates to use AXYL as sole carbon source. Apart from *Flavobacterium*, no other tested HAGW isolate demonstrated zone of clearing on either plastic or cellulosic and hemicellulosic substrates.



**Fig. 1.** Production of zone of clearing on Imprani® DLN-SD substrate for groundwater *Flavobacterium* isolate HAGW-14.

The presence of genus *Flavobacterium* was previously documented in serpentinization-driven groundwaters [20], and the HAGW occurrence examined in this work, in which *Flavobacterium* with IMP-SD degrading potential was detected, also belong to the same group of groundwaters [3]. The presence of *Flavobacterium* has also been detected previously by means of metagenomics in brackish weakly alkaline groundwater occurrence (TDS – 7440 mg/L; pH – 7.6) [21]. Another isolate with IMP-SD degrading activity, with its 16S sequence closely clustering with 16S sequence from the HAGW-14 isolate, was detected by functional screening from brackish weakly acidic groundwater [22], suggesting a wide range of conditions in which this genus persists in environment.

The role of alkaliphiles in the degradation of plastic polymers is known, with most of the documented alkaliphilic plastic-degrading bacteria belonging to the group of obligate alkaliphiles [8]. The plastic-degrading potential of *Flavobacterium* has been previously documented for members of genus *Flavobacterium* [23] and we confirmed the IMP-SD degrading potential of isolate belonging to this genus (Fig. 1), originally isolated from LA cultivation medium with pH value of 7. This is, to our knowledge, the first report of PU-degrading activity for *Flavobacterium*.

Activity on the IMP-SD substrate, a model substrate for PU, is especially notable. PU, a heterogeneous group of polymers widely used in the form of thermoplastics, thermosets or foams, are among the more commonly produced plastic polymers, with an annual production of more than 27 million tons, leading to their rapid accumulation in the environment [12, 13]. Pollution with this polymer is of special concern, as PU plastics and its microplastics have been identified as one of the most toxic types of plastic [24, 25] and, due to a lack of efficient recycling strategies, present an ongoing issue. Plastic particles are leaching in groundwater from various sources [26, 27], including landfills, surface water, urban infrastructure, atmosphere, agricultural land [28], wastewater effluent [29] and fragmentation of fishing nets [30]. Prolonged consumption of groundwater contaminated with plastic particles may have a negative impact on human health [29]. Therefore, it is particularly important to invest efforts in the sustainable use of this natural resource and management of microplastic contamination in groundwater.

## CONCLUSION

The investigated HAGW were characterized by the presence of aerobic cultivable bacteria with the ability to persist in a range of pH values (7-12). HAGW *Flavobacterium* demonstrated PU-degrading potential, and this genus should be further explored for its applications in bioremediation treatments of PU-polluted groundwaters. In the future, biotechnological potential of alkalophilic bacteria from groundwater environments should be explored more intensively, especially from the aspect of their application in the management plastic waste.

## ACKNOWLEDGMENT

This work was supported by the European Union's H2020 Research and Innovation Programme under grant agreement No. 870292 (BioICEP) and by the Ministry of Science, Innovation and Technological Development of the Republic of Serbia (Agreement No. 451-03-47/2023-01/200042). HAGW-14 16S rDNA sequence is available in the NCBI GeneBank database under accession number OR116172.

## REFERENCES

- [1] Villeneuve, K., Violette, M., Lazar, C. S., From Recharge, to Groundwater, to Discharge Areas in Aquifer Systems in Quebec (Canada): Shaping of Microbial Diversity and Community Structure by Environmental Factors, *Genes*, Vol.14, 2022.
- [2] Dragišić, V., Živanović, V., *Opštahidrogeologija*, University of Belgrade, Faculty of Mining and Geology, 2014.
- [3] Dragišić, V., Tišma, R., Milenić, D., Miladinović, B., Potkonjak, B., Špadijer, S., *Hiperalkalnemineralne vode Srbije*, International Conference "Water for the 21<sup>st</sup> century", pp. 611-618, 1999.
- [4] Nikić, Z., Srećković-Batočanin, D., Burazer, M., Ristić, R., Papić, P., Nikolić, V., A conceptual model of mildly alkaline water discharging from the Zlatibor ultramafic massif, western Serbia, *Hydrogeology journal*, Vol.21, 2013.
- [5] Mojsilović, S., Baklajić, D., Đoković, I., & Avramović, V., Tumač za list TitovoUžice, Federal Geological Survey, 1978.
- [6] Baculi, R. Q., Lantican, N. B., De Los Reyes, F. L., & Raymundo, A. K., Prokaryotic community analysis of a hyperalkaline spring in the Philippines using 16S rRNA gene clone library construction, *Philippine Journal of Science*, Vol.144, pp. 1-12, 2015.
- [7] Preiss, L., Hicks, D. B., Suzuki, S., Meier, T., Krulwich, T. A., Alkaliphilic bacteria with impact on industrial applications, concepts of early life forms, and bioenergetics of ATP synthesis, *Frontiers in bioengineering and biotechnology*, Vol.3, 2015.
- [8] Atanasova, N., Stoitsova, S., Paunova-Krasteva, T., Kambourova, M., Plastic degradation by extremophilic bacteria, *International Journal of Molecular Sciences*, Vol.22, pp. 1-19, 2021.
- [9] Fones, E. M., Colman, D. R., Kraus, E. A., Stepanauskas, R., Templeton, A. S., Spear, J. R., Boyd, E. S., Diversification of methanogens into hyperalkaline serpentinizing environments through adaptations to minimize oxidant limitation, *The ISME journal*, Vol.15, pp. 1121-1135, 2021.
- [10] Griebler, C., Avramov, M., Groundwater ecosystem services: A review, *Freshwater Science*, Vol.34, pp. 355-67, 2015.
- [11] Statista Research Department, Annual production of plastics worldwide from 1950 to 2021, 2023, Available at: <https://www.statista.com/statistics/282732/global-production-of-plastics-since-1950/>
- [12] Nikolaivits, E., Pantelic, B., Azeem, M., Taxeidis, G., Babu, R., Topakas, E., Fournet, M. B., Nikodinovic-Runic, J., Progressing plastics circularity: A review of mechano-biocatalytic approaches for waste plastic (re) valorization, *Frontiers in Bioengineering and Biotechnology*, Vol. 9, pp. 1-31, 2021.

- [13] Danso, D., Chow, J., Streit, W. R., *Plastics: environmental and biotechnological perspectives on microbial degradation*, Applied and environmental microbiology, Vol.85, pp. 1-14, 2019.
- [14] Liu, J., He, J., Xue, R., Xu, B., Qian, X., Xin, F., Blank, L. M., Zhou, J., Wei, R., Dong, W., Jiang, M., *Biodegradation and up-cycling of polyurethanes: Progress, challenges, and prospects*, Biotechnology advances, Vol.48, pp. 1-12, 2021.
- [15] Jiménez, D. J., Öztürk, B., Wei, R., Bugg, T. D., Amaya Gomez, C. V., Salcedo Galan, F., Castro-Mayorga, J. L., Saldarriaga, J. F., Tarazona, N. A., *Merging plastics, microbes, and enzymes: highlights from an international workshop*, Applied and Environmental Microbiology, Vol.88, 2022.
- [16] Chen, C. C., Dai, L., Ma, L., & Guo, R. T., *Enzymatic degradation of plant biomass and synthetic polymers*, Nature Reviews Chemistry, Vol.4, pp. 114-126, 2020.
- [17] Horikoshi, K., *Alkaliphiles*, Proceedings of the Japan Academy, Series B, Vol.80, pp. 166-178, 2004.
- [18] Madigan, M. T., Martinko, J. M., Stahl, D. A., & Clark, D. P., *Brock biology of microorganisms* (13<sup>th</sup> edition), Pearson Benjamin-Cummings, 2010.
- [19] Kanekar, P. P., Kanekar, S. P., *Alkaliphilic, Alkalitolerant Microorganisms, Diversity and Biotechnology of Extremophilic Microorganisms from India*, Springer, Singapore, pp. 71-116, 2022.
- [20] Twing, K. I., Brazelton, W. J., Kubo, M. D., Hyer, A. J., Cardace, D., Hoehler, T. M., McCollom, T. M., Schrenk, M. O., *Serpentinization-influenced groundwater harbors extremely low diversity microbial communities adapted to high pH*, Frontiers in microbiology, Vol.8, 2017.
- [21] Šaraba, V., Dragišić, V., Janakiev, T., Obradović, V., Čopić, M., Knežević, B., Dimkić, I., *Bacteriome composition analysis of selected mineral water occurrences in Serbia*, Archives of Biological Sciences, Vol.74, pp. 67-79, 2022.
- [22] Ciric, M., Pantelic, B., Šaraba, V., Nikodinovic-Runic, J., *Groundwater and soil as a reservoir for polyurethane-degrading bacteria*, Belgrade Bioinformatics Conference, 2023., Abstract in press.
- [23] Logan, M., *Identifying Key Bacteria in Microbiomes of Microplastics Found in Marine Environments for Possible Degradation*, University of Glasgow, 2023.
- [24] Yuan, Z., Nag, R., Cummins, E., *Ranking of potential hazards from microplastics polymers in the marine environment*, Journal of Hazardous Materials, Vol.429, 2022.
- [25] Zimmermann, L., Dierkes, G., Ternes, T. A., Völker, C., Wagner, M., *Benchmarking the in vitro toxicity and chemical composition of plastic consumer products*, Environmental science & technology, Vol.53, 2019.
- [26] Samandra, S., Johnston, J. M., Jaeger, J. E., Symons, B., Xie, S., Currell, M., Ellis, A. V., Clarke, B. O., *Microplastic contamination of an unconfined groundwater aquifer in Victoria, Australia*, Science of the Total Environment, Vol.802, 2022.
- [27] Khant, N. A., Kim, H., *Review of current issues and management strategies of microplastics in groundwater environments*, Water, Vol.14, 2022.
- [28] Viaroli, S., Lancia, M., Re, V., *Microplastics contamination of groundwater: Current evidence and future perspectives. A review*, Science of The Total Environment, Vol.824, 2022.
- [29] Chia, R. W., Lee, J. Y., Kim, H., Jang, J., *Microplastic pollution in soil and groundwater: a review*, Environmental Chemistry Letters, Vol.19, pp. 4211-4224, 2021.
- [30] Selvam, S., Jesuraja, K., Venkatramanan, S., Roy, P. D., Kumari, V. J., *Hazardous microplastic characteristics and its role as a vector of heavy metal in groundwater and surface water of coastal south India*, Journal of Hazardous Materials, Vol.402, 2021.



**XIII International Conference Industrial  
Engineering and Environmental  
Protection 2023 (IIZS 2023)  
October 05-06, 2023, Zrenjanin, Serbia**

---

## **Session 7**

# **Environmental Management and Occupational Safety**



## POTENTIAL IMPACT OF HOME COMPOSTING ON ORGANIC WASTE DIVERSION FROM LANDFILLS IN SERBIA

Igor Jezdimirović<sup>1</sup>, Zoran Čepić<sup>1</sup>, Nemanja Stanisavljević<sup>1</sup>, Višnja Mihajlović<sup>2</sup>, Xiaoming Wang<sup>3</sup>

<sup>1</sup> University of Novi Sad, Faculty of Technical Sciences, Novi Sad, Serbia

<sup>2</sup> University of Novi Sad, Technical Faculty "Mihajlo Pupin", Zrenjanin, Serbia

<sup>3</sup> Chongqing University, Key Laboratory of Three Gorges Reservoir Region's Eco-Environment, Ministry of Education, Chongqing, PR China

e-mail: [igor\\_jezda@yahoo.co.uk](mailto:igor_jezda@yahoo.co.uk)

**Abstract:** Home composting can divert huge portion of household waste from landfill. However, national rates of composting remain low in many parts of the globe, especially in developing countries like Serbia. This review critically evaluates the environmental impacts of home composting, its critical stages in developing countries and potential benefits of home composting in Serbia. The systematic literature search yielded 595 titles and abstracts which were reviewed and resulted in 14 unique interventions. Synthesized results indicate that home composting is viable method of diverting organic waste from landfill, with several risks that can be attenuated. In addition, critical aspects of composting in developing countries are recognized. Finally, potential benefits of home composting in Serbia has been reported. This review highlights gaps in the design of waste management interventions and provides suggestions for future practices.

**Key words:** waste management intervention, home composting, organic waste

### INTRODUCTION

Biodegradable material, food waste in particular, accounts for over 50% of the municipal waste stream in both developed and less developed countries [1-3]. The management of the organic fraction of municipal solid wastes is a growing problem due to the rapid collapse of landfills worldwide and the possible contamination and loss of organic resources derived from landfilling. Thus, diversion of organic material from the waste stream is preferred for further treatment by more environmentally friendly methods, such as composting. Composting is the process of transforming raw organic waste into biologically stable, humic substances suitable for a variety of uses. Diverting municipal solid waste (MSW) organic material from landfills by composting has many environmental benefits, such as reducing greenhouse gas emissions [4], decreasing leachate quantities once discarded in landfills [5], and increasing the calorific value of feedstock [6]. Production of compost used as organic fertilizer or for soil amendments, can also be obtained from the diversion of organic material from landfill disposal or incineration. Adding compost to soil provides additional nutrients for plant growth, improves the soil structure, increases the water retention capacity, and reduces the reliance on fossil-fuel-based fertilizers [7-9].

In addition to the reduction of the total amount of wastes being dumped, composting kills most of the pathogenic microorganisms and reduces odour compounds obtaining a valuable product named compost. Compost can be applied as a fertilizer, organic amendment or growing medium, improving soil quality, water retention and the supply of essential nutrients [10-13]. However, when improperly managed and performed, composting may lead to various environmental issues, including the toxic gases-formation [14], bioaerosols [15], and dust [16], resulting in occupational health risks [17,18]. Home composting includes biodegradation of municipal organic waste (MOW) (including food waste and garden waste) as well as the use of compost in a private garden at household scale [19]. Home composting avoids the collection of an important part of municipal solid wastes, thus reducing the

economic, material and energetic investments in infrastructures [20-22]. It implies less land use and, finally, it allows a more specific control of the composting process and the organic materials treated. However, while removing green waste from the municipal waste stream has long been implemented in developed countries [23-25], food waste diversion lags far behind [26]. Home composting which means the composting of biowaste as well as the use of the compost in a private garden [27], presents some potential benefits in comparison to industrial composting. In the last two decades, EU countries have adopted several measures to reduce the amount of biodegradable municipal waste sent to landfills and recycle organic fractions. There is general consensus that home composting have not become a focus in developed countries yet, with even more problematic situation in developing countries [28]. In most developing countries, lacks of resources and legislative measures is common and solid waste management is underdeveloped and related data is unreliable and incomplete [29]. According to latest data [30], 2.9 million tons of waste is generated in Serbia each year (quantity varies from 0.28 kg capita-1 day-1 to 1.54 kg capita-1 day-1), with another 600,000 tons isn't collected and isn't landfilled at sanitary landfills or garbage dumps. In addition, organic waste represents 48,8% of the total mass quantity, with 44% of biodegradable waste usable for composting or anaerobic digestion or biogas production. It has been presented [31] that the largest percentage of municipal waste in Serbia is biodegradable waste – food waste. Similar data were presented in the study by Vemic et al. [32] with "other biodegradable waste" being presented with around 31%, three times more than garden waste as can be seen from the presented data, there is substantial capacity in Serbia to conduct home-composting procedures and consequently provide substantial impact on different environmental aspects, including diversing from landfills. The main objectives of this study are to review current literature about the environmental impacts associated to home composting, to detect its critical stages from an environmental point of view and to assess the potential benefits of home composting in Serbia.

## **MATERIAL AND METHODS**

### **Data sources and search method**

In order to produce a thorough and transparent review we followed reporting of items in systematic reviews and meta-analysis (PRISMA) guidelines. This research pursued studies that had been peer reviewed, in the English language, and published between 2012 and Jun 2022 within two public, commonly used electronic databases: Science Direct and Web of Science. These databases were used as the world's leading sources for scientific research in multiple science fields including environmental protection. Key-terms used for database search included: "home composting\*" AND "organic wastes\*" OR „Serbia landfills\*“.

### **Eligibility criteria and study screening**

After removing duplicates, individual records were screened and excluded using the following criteria: (a) non-journal articles; (b) not related to composting behaviour; (c) focused on other types of waste; (d) focused on energy and emissions and (e) focused on technical aspects of composting (e.g., techniques and equipment, temperature control, soil conditions, quality assessment, and chemical composition of compost).

During first-level screening of abstracts, the exclusion criteria are used to filter irrelevant articles. After this, full-length articles were inspected to reveal empirical studies that matched the inclusion criteria of home-composting and organic waste.

## **RESULTS AND DISCUSSION**

A total of 595 studies were retrieved from the literature search. Of these, 534 studies were discarded because after reviewing it appeared that the articles clearly did not meet the



criteria. The full text of the remaining 61 citations was examined in more detail. It appeared that 50 did not meet the inclusion criteria as described. Checking the references of located, relevant articles and searching the studies that have cited these papers, we identified an additional three studies that met the criteria for inclusion. Overall, 14 studies met the eligibility criteria.

Due to the heterogeneity of study aims, we obtained a very diverse sample of articles. In that context, representation of the data was presented by simply drawing conclusions from the individual articles results. We identified 3 groups of articles considering study objectives, first discussing environmental impact of home composting, second dealing with issues in developing countries and third oriented toward home composting in Serbia. We review studies Accordingly.

Estimated solid waste generation on a global basis will raise from 12.7 billion tones in 2000 to 27 billion tones in 2050. In preserving ecosystem stability and sustainability, it seems essential to streamline the systems for waste management so as to reduce waste production to the maximum extent possible. In this context composting is considered viable to significantly reduce the organic waste that goes for final disposal in landfills and dump sites [33]. The impact compost makes on society goes far beyond this and meets many distinct objectives across sectors. From the environmental, economic, and social perspectives, composting turns organic wastes into compost useful for agricultural activities and soil restoration which is carbon-, water-, and nutrient-rich and free of most pathogens. Thus, organic waste recycling through composting addresses the well-known three pillars of sustainability: the society, the economy, and the environment. Environmental impact of home composting is likely of crucial importance, so we will overview articles with this study aim.

### **Home composting – environmental impact**

Environmental impact of home composting have been studied extensively. The main advantage is the absence of waste transport and lower energy requirements, but the lack of gaseous emissions control is a possible disadvantage. Several studies compared home composting with industrial composting from environmental point of view. The preliminary studies on this topic were presented by Colón et al. [19]

and Andersen et al. [34] with similar conclusion that home composting appears superior to other waste management technologies in most of the impact categories, with gaseous emissions being main negative contributor (global warming potential). Further studies were oriented on gaseous emissions during the home composting process [35]. For example, [36] investigated the greenhouse gases emissions of several home composters in comparison with previous data from full-scale composting, finding home composting emitted less methane than large-scale composts but similar amounts of nitrous oxide. Similarly, Colon et al. [37] have focused on this comparison in more rigorous study with the same initial mixture, season, and location, with more environmental categories studied. Four different full-scale facilities treating a source-selected organic fraction of Municipal Solid Waste were environmentally evaluated with an LCA, including composting technologies (in-vessel, turned piles, and home composting) and anaerobic digestion plus composting. Again, home composting was found superior in comparison to other composting technologies in terms of environmental impact. Furthermore, one study directly compared a complete LCA home and industrial composting [38]. The obtained results were in line with aforementioned studies, Ammonia, methane and nitrous oxide released from home composting were considerably higher than those of industrial composting. However, this latter option involved 2 and 53 times more needs for transport, energy, water, and infrastructure. It can be concluded that home and community composting has a great potential to be a massively implemented strategy in organic waste management, as from environmental point of view home composting appears superior to industrial composting in most of the environments categories.

## **Critical aspects of home composting in developing countries**

In developing countries there is a growing concern of inappropriate waste management, especially in urban areas. Though collection services of municipal waste in developing countries often account for the largest percentage of the municipal waste management budget, the collection systems are often insufficient. Furthermore, there is general deficiency in transport services quality, as well as suitable treatment and disposal facilities [39]. The most common disposal method is open and uncontrolled dumping at dumpsites, but also dumping in streets, drains, rivers, oceans occur frequently, as well as burning of waste in the backyard [40]. The volume and type of municipal solid waste (MSW) generated in developing countries depends on the standard of living, consumption patterns, commercial and institutional activities and the geographical location. In developing countries a large part of the municipal solid waste flow is organic, biodegradable wastes, which originate from households, including peelings from fruit and vegetables, food remnants and leaves [41]. Municipal solid waste produced in low- and middle-income countries usually has a much higher organic fraction compared to the same volume in high-income countries [42]. It ranges from 45% up to more than 80% of the whole waste, representing the main source of health and environmental concerns [43,44]. Due to the specificities associated with the waste rates and developmental differences outlined, it seems that central and especially home composting focusing on high organic content could be a suitable alternative to waste management instead of the waste-to-energy or waste-to-landfill strategies often used today in developed countries [45]. In some developing countries composting is advancing, mainly in Asian countries. Drescher and Zurbrugg [46] suggested there are few composting facilities for organic household wastes in developing countries. Studies of home composting in developing countries are scarce. Recently, Kopaei et al, [47] analyzed determinants of home composting intentions in Iran. Total of 367 respondents (36% males and 64% females) were included in the study fulfilled the questionnaire structured according to the components of the conceptual framework, with composting knowledge measured with a binary question (low or high). results showed that people with a positive attitude toward home composting are more likely to engage in that behavior. Furthermore, women are more prone to pro-environmental behavior. Therefore, home composting programs and training should prioritize females. Similarly, to aforementioned study, Loan et al [48], in a survey of 202 respondents in rural areas of Hoi An, Vietnam, indicates that households' decisions to get involved in a home composting scheme and the level of home composting participation are affected by motivational factors such as knowledge about home composting, attitude toward it, and owning a garden.

To successfully introduce home composting in developing countries, environmental behavior, education, adoption to local conditions and markets, and bottom-up driving forces are crucial aspects to address for long term sustainability

## **Home composting in Serbia - opportunities and challenges**

The Government of the Republic of Serbia adopted the "National Strategy for Sustainable Development" for the period 2008–2017, in which it presented a vision of sustainable development of the country. Composting is one of the possibilities to instill sustainable development. Serbia, as well as other countries of Europe and the world, is trying to systematically solve the problem of waste. Goals of reducing total waste disposal for 25% in the period from 2012 to 2016, while up to 2026 the rate of reduction of 65% is determined. The annual amount of municipal waste in the Republic of Serbia is 2.448.566 tons or approximately 0,90 kg per capita per day. The largest share in municipal waste is organic waste, with a share of 43%. Another study [32] reported the so-called "other biodegradable waste" (bread, meat, vegetables, animal organs) is represented by 31.0%, which amounts about three times more of it than garden waste. It has been hypothesized that in 2005 there was somewhere between 59 to 96 tons of waste that could be composted in Novi Sad solely

[32]. This is substantial amount of waste which could lead to myriad benefits on overall sustainability. In Serbia, there is no institute that deals with the problem of waste, especially of composting, there are no official statistics, and presented data are the result of scientific research of the faculty and researchers who are working on a case- by-case basis. In addition, the municipal waste separation system is still in its infancy. Only few of local governments provided households with special bins, which is of exceptional significance for establishing an efficient system for recycling packaging waste and composting biodegradable waste. Clearly, urgent action plan is needed in this context.

## CONCLUSION

The source separated collection and recycling of municipal solid waste are crucial processes for establishing sustainable waste management strategies. Home composting, which numerous benefits from both ecological and economic perspectives, is an important segment for the promotion of organic waste recycling. With the uprising need to instill high recycling rates in countries worldwide, source separation of waste will continue to be implemented in more countries and regions, Serbia included. Consequently, home composting will likely become an increasingly important component in waste treatment systems worldwide, with developing country, like Serbia, being integral part of the process. State and municipalities could adopt goals for reducing or eliminating organic waste landfilling so that composting becomes more widespread and more economically viable.

## REFERENCES

- [1] Alexis, M.T. and James, R.M., Sustainable recycling of municipal solid waste in developing countries, *Waste Manage*, No.29, pp. 915–923, 2009.
- [2] Tai, J., Zhang, W.Q., Che, Y. and Feng, D., Municipal solid waste source-separated collection in China: a comparative analysis, *Waste Manage*, No. 31, pp.1673–1682, 2011.
- [3] Thi, N.B.D., Kumar, G. and Lin, C.Y., An overview of food waste management in developing countries: current status and future perspective. *J. Environ. Manage*. No.157, pp. 220–229, 2015.
- [4] United States Environmental Protection Agency (USEPA), 2013. Advancing Sustainable Materials Management: 2013 Fact Sheet- Assessing Trends in Material Generation, Recycling and Disposal in the United State. June, 2015, <https://ilsr.org/state-of-composting/>(Accessed 10 June 2015).
- [5] Adhikari, B.K., Barrington, S., Martinez, J. and King, S., Effectiveness of three bulking agents for food waste composting. *Waste Manage*, No. 29, pp. 197–203, 2009.
- [6] Zhou, H., Meng A. h. Long, Y.Q., Li, Q.H. and Zhang, Y.G., An overview of characteristics of municipal solid waste fuel in China: physical, chemical composition and heating value. *Renew. Sustain. Energy Rev.*, No. 46, pp. 107–122, 2014.
- [7] Jorda o, C.P., Nascentes, C.C., Cecon, P.R., Fontes, R.L.F. and Pereira, J.L., Heavy metal availability in soil amended with composted urban solid wastes. *Environ. Monit. Assess*, No. 112, pp. 309–326, 2006.
- [8] Chen, M., Xu, P., Zeng, G.M., Yang, C.P., Huang, D.L. and Zhang, J.C., Bioremediation of soils contaminated with polycyclic aromatic hydrocarbons, petroleum, pesticides, chlorophenols and heavy metals by composting: applications, microbes and future research needs. *Biotechnol. Adv.*, No. 33, pp. 745–755, 2015.
- [9] Hernández, T., Garcia and E., García, C., A strategy for marginal semiarid degraded soil restoration: a sole addition of compost at a high rate. A five-year field experiment. *Soil Biol. Biochem*, No. 89, pp. 61–71, 2015.
- [10] McConnell, DB., Shiralipour, A. and Smith, WH., Agricultural impact—compost application improves soil properties. *Biocycle*, No. 34, pp.61–3, 1993.

- [11] Jakobsen, S.T. Aerobic decomposition of organic wastes II: value of compost as a fertilizer. *Resour Conserv Recycl*, No. 13, pp. 57–71, 1995.
- [12] Hargreaves, J.C., Adl, M.S. and Warman, P.R., A review of the use of composted municipal solid waste in agriculture. *Agric Ecosyst Environ*, No.123, pp. 1–14, 2008.
- [13] Martínez-Blanco, J., Munoz, P., Antón, A. and Rieradevall, J., Life cycle assessment of the use of compost from municipal organic waste for fertilization of tomato crops. *Resour Conserv Recycl*, No. 53, pp. 340–51, 2009.
- [14] Komilis, D.P., Ham, R.K. and Park, J.K., Emission of volatile organic compounds during composting of municipal solid wastes. *Water Res.*, No. 38, pp. 1707–1714, 2004.
- [15] Wéry, N., Bioaerosols from composting facilities—a review. *Front. Cell. Infect. Microbiol.*, No. 4, pp. 42–42, 2014.
- [16] Byeon, J.H., Park, C.W., Yoon, K.Y., Park, J.H. and Hwang, J., Size distributions of total air borne particles and bioaerosols in a municipal composting facility. *Bioresour. Technol.*, No. 99, pp. 5150–5154, 2008.
- [17] Sykes, P., Jones, K. and Wildsmith, J.D., Managing the potential public health risks from bioaerosol liberation at commercial composting sites in the UK: an analysis of the evidence base. *Resour. Conserv. Recycl.* No. 52 Vol. 2, pp. 410–424, 2007.
- [18] Van Kampen, V., Sander, I., Liebers, V., Deckert, A., Neumann, H.D., Buxtrup, M., Willer, E., Felten, C., Jäckel, U., Klug, K., Brüning, T., Raulf, M. and Bünger, J., Concentration of bioaerosols in composting plants using different quantification methods. *Ann. Occup. Hyg.*, No. 58, pp. 693–706, 2014.
- [19] Colón, J., Martínez-Blanco, J., Gabarrell, X., Artola, A., Sánchez, A., Rieradevall, J., & Font, X., Environmental assessment of home composting. *Resources, Conservation and Recycling*, No. 54(11), pp. 893-904, 2010.
- [20] Jasmin S. and Smith S., The practicability of home composting for the management of biodegradable domestic solid waste. London: Centre for Environmental Control and Waste Management, Department of Civil and Environmental Engineering; 2003.
- [21] Ligon P. and Garland G., Analyzing the costs of composting strategies. *Biocycle*, No. 39, pp. 30–7, 1998.
- [22] McGovern A. Home composting makes major impact. *Biocycle*, No. 38 Vol.30, 1997.
- [23] Levis, J.W., Barlaz, M.A., Themelis, N.J. and Ulloa, P., Assessment of the state of food waste treatment in the United States and Canada. *Waste Manage.*, No. 30, pp. 1486–1494, 2010.
- [24] United States Environmental Protection Agency (USEPA), 2013. Advancing Sustainable Materials Management: 2013 Fact Sheet- Assessing Trends in Material Generation, Recycling and Disposal in the United State. June, 2015, <https://ilsr.org/state-of-composting/> (Accessed 10 June 2015).
- [25] Slater, R.A. and Frederickson, J., Composting municipal waste in the UK: some lessons from Europe. *Resour. Conserv. Recycl.* No. 32, pp. 359–374, 2001.
- [26] Wei, Y., Li, J., Shi, D., Liu, G., Zhao, Y. and Shimaoka, T., Environmental challenges impeding the composting of biodegradable municipal solid waste: A critical review. *Resources, Conservation and Recycling*, No. 122, pp. 51-65, 2017.
- [27] European Commission. Green paper on the management of bio-waste in the European Union; 2008.
- [28] Scheinberg, A., and Zheng, Y., No place like home: capacity development in master composting programmes. *Urban Agriculture Magazine*, No. 23, pp. 35-38, 2009.
- [29] Hristovski, K., Olson, L., Hild, N., Peterson, D. and Burge, S., The municipal solid waste system and solid waste characterization at the municipality of Veles, Macedonia. *Waste Management*, No. 27(11), pp.1680-1689, 2007.
- [30] State of the Environment in the Republic of Serbia Report for 2020.
- [31] Tošić, N. and Vasović, D., Analysis of contemporary municipal waste management practice in the Republic of Serbia. *Safety Engineering*, No. 10(2), pp. 89-96, 2020.

- [32] Vemić, M., Komazec, G. and Žujović, Z., Composting in Serbia: Possibilities and limitations. *Journal of the Geographical Institute "Jovan Cvijic", SASA*, No. 64(2), pp. 193-205, 2014.
- [33] Pace, S. A., Yazdani, R., Kendall, A. and Simmons, C. W., Impact of organic waste composition on life cycle energy production, global warming and water use for treatment by anaerobic digestion followed by composting. *Resources, Conservation & Recycling*, No.137, pp. 126–135, 2018.
- [34] Andersen, J. K., Boldrin, A., Christensen, T. H. and Scheutz, C., Home composting as an alternative treatment option for organic household waste in Denmark: An environmental assessment using life cycle assessment-modelling. *Waste management*, No. 32(1), pp. 31-40, 2012.
- [35] Quirós, R., Villalba, G., Muñoz, P., Colón, J., Font, X. and Gabarrell, X., Environmental assessment of two home composts with high and low gaseous emissions of the composting process. *Resour. Conserv. Recycl.* No. 90, pp. 9–20, 2014.
- [36] Ermolaev, E., Sundberg, C., Pell, M., Jönsson, H. Greenhouse gas emissions from home composting in practice. *Bioresour. Technol.*, No. 151, pp. 174–182, 2014.
- [37] Colón, J., Cadena, E., Pognani, M., Barrena, R., Sánchez, A., Font, X. and Artola, A., Determination of the energy and environmental burdens associated to the biological treatment of source-separated Municipal Solid Wastes. *Energy Environ. Sci.*, No. 5, pp. 5731–5741, 2012.
- [38] Martínez-Blanco, J., Colón, J., Gabarrell, X., Font, X., Sánchez, A., Artola, A. and Rieradevall, J., The use of life cycle assessment for the comparison of biowaste composting at home and full scale. *Waste Manag.* No. 30, pp. 983–994, 2010.
- [39] EAWAG: Swiss Federal Institute of Aquatic Science and Technology (2008), *Global Waste Challenge – Situation in Developing Countries*: EAWAG, Switzerland.
- [40] Environmental Foundation, 2007. Climbing out of the garbage dump: managing Colombo's solid waste problem. Available from: <http://efl.lk/wpcontent/uploads/2009/09/Solid.waste.EFL.PP.04.pdf> [Accessed 7 May 2010].
- [41] Cointreau S., *Occupational and Environmental Health Issues of Solid Waste Management, Special Emphasis on Middle- and Lower-Income Countries*. 2006. Available from: [http://www.wiego.org/occupational\\_groups/pdfs/waste\\_collectors/Urban\\_Paper\\_Health\\_Solid\\_Waster\\_Mgt.pdf](http://www.wiego.org/occupational_groups/pdfs/waste_collectors/Urban_Paper_Health_Solid_Waster_Mgt.pdf) [Accessed 12 April 2010].
- [42] Kaza, S., Yao, L., Bhada-Tata, P., and Van Woerden, F., *What a waste 2.0: A global snapshot of solid waste management to 2050 (Urban Development Series)*. Washington, DC: World Bank., 2018.
- [43] Al-Khatib, I. A., Monou, M., Zahra, A. S. F. A., Shaheen, H. Q., and Kassinos, D., Solid waste characterization, quantification and management practices in developing countries. A case study: Nablus district–Palestine. *Journal of environmental management*, No. 91(5), pp. 1131-1138, 2010.
- [44] Zhang, D.Q., Tan, S.K. and Gersberg, R.M., Municipal solid waste management in China: Status, problems and challenges. *Journal of Environmental Management* No. 91, pp. 1623-1633, 2010.
- [45] Fogarassy, C., Hoang, N.H. and Nagy-Pércsi, K. Composting Strategy Instead of Waste-to-Energy in the Urban Context—A Case Study from Ho Chi Minh City, Vietnam. *Appl. Sci.*, No. 12, pp. 2218, 2022.
- [46] Drescher S. and Zurbrügg C., Decentralised composting: Lessons learned and future potentials for meeting the millennium development goals. In: *CWG – WASH Workshop 2006*, 1-5 February.
- [47] Kopaei, H. R., Nooripoor, M., Karami, A. and Ertz, M., Modeling consumer home composting intentions for sustainable municipal organic waste management in Iran. *AIMS Environmental Science*, No. 8(1), pp. 1-17, 2021.

- [48] Loan, L.T.T., Takahashi, Y., Nomura, H. and Yabe, M. Modeling home composting behavior toward sustainable municipal organic waste management at the source in developing countries. *Resour. Conserv. Recycl.*, No. 140, pp. 65–71, 2019.



## DETERMINATION OF CHEMICAL PROPERTIES OF SOILS IN ZRENJANIN PARKS

Milana Drašković<sup>1</sup>, Nataša Zec<sup>1</sup>

<sup>1</sup>Technical College of Applied Sciences, Zrenjanin, Serbia

e-mail: [draskovic.milana@gmail.com](mailto:draskovic.milana@gmail.com)

**Abstract:** Parks and trees in parks have multi-aspect influence on the microclimate in urbanised areas. The aim research was to assess the chemical composition of soils and the nutritional status in selected sites in parks in different parts of the city Zrenjanin. The soils were analysed for the content of macro and microelements. The research showed that in general, the soil in all the sites was alkalized (8,58). The following values of nutrients were: N 5- 25 mg/L, P 30- 50 mg/L, K 20-40 mg/L, Mg 100-175 mg/L, Ca 1500-2000 mg/L.

**Key words:** Chemical characteristics of soil, urban soils, urban zones, land use, anthropogenic impact, urban ecology.

### INTRODUCTION

Urban soils have been significantly changed compared to natural, because of the influence of anthropogenic factors. The increased level of urbanization leads to a decrease in the share of natural lands in urban areas and changes due to the action of anthropogenic factors [1,2]. Parks occupy a special place in the urban space, considering the increasing demands of society towards green areas [3]. In the Republic of Serbia, according to census data from 2002, 56.7% of the population lives in cities [4]. The increase in the number of inhabitants in cities has a significant impact on the quality of green areas. The lands of parks are classified as desopol soils, [5] i.e. technosol soils.

It was found that the chemical characteristics of the soil are significantly correlated with the processes of urbanization [6]. Research by different authors [7,8] has shown that urban soils have a soil reaction that is somewhat different from the reaction of natural soils. In most cases, pH values are higher in urban areas, where weakly alkaline soils dominate. The consequence of the increased pH value of urban soils comes from the presence of carbonate anthropogenic materials such as cement, mortar, concrete, various types of bricks, etc. [9].

The goal of the research is to evaluate the chemical properties of the soil in selected parks of the city of Zrenjanin that are under anthropogenic influence. The chemical properties are: humus content, macroelement content, microelement content, pH value, salt content, etc. These properties can be determined by standard methods, but modern devices are increasingly being used to achieve the desired results more quickly. One of those devices is the Palintest SK 300® soil analyzer. It is also important to assess how the content of macronutrients in the soil affects the health of trees in city parks.

### MATERIAL AND METHODS

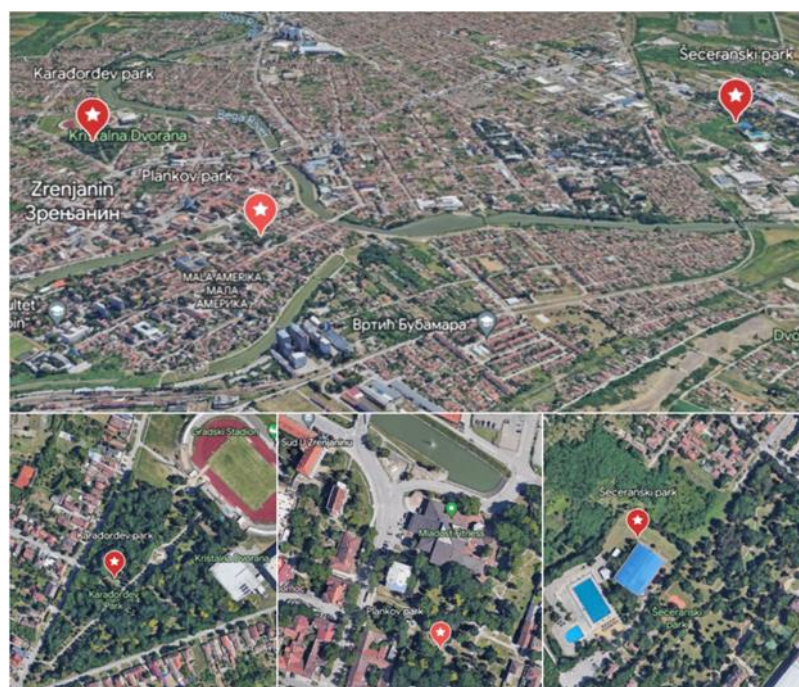
The city of Zrenjanin (52°24'30.4"N, 16°56'03.4"E) is the largest city in the Autonomous Province of Vojvodina and the second in the Republic of Serbia, with a territory of 1,326 km<sup>2</sup>. Of the area belonging to the City of Zrenjanin, 82.5% is agricultural land. According to the 2011 census, 123,362 inhabitants live on the territory of the City, and 76,511 inhabitants live in Zrenjanin itself. According to the number of inhabitants, Zrenjanin is the largest city in Banat and it's economic, cultural, educational, health and sports center of Banat. Zrenjanin had the name Bečkerek for six centuries from 1326 to 1935, when it was named Petrovgrad, after King Petar I Karađorđević. It got its current name after the Second World War, after the revolutionary Žarko Zrenjanin.



According to the pedological map of Vojvodina, the area of the city is macroscopically divided into two pedological categories: carbonate chernozem, on the higher parts of the loess terrace, and solonjec-saltmarsh in the Begej valley. According to some local pedological tests that were carried out for individual detailed urban planning solutions, the same areas are marked on the mentioned map as solonjec, i.e. varieties of rite *crnica* and *smonica* [10]. In Zrenjanin there are more separate green areas in the city. These are numerous parks: Karađorđev, Šećeranski, Plankert (Fig. 1.). The study was conducted in public parks in Zrenjaninu, used by citizens for recreation and passive rest. The location of the research parks are given on the Fig. 2. Table 1 displays the coordinates of the examined parks, their surface area, as well as the altitude.



**Fig. 1.** Parks of the city of Zrenjanin



**Fig. 2.** The locations of the research Parks

The research sites were located in different parts of the city—both closer to the centre and housing estates.

**Table 1.** Coordinates, surface area, and altitude of the research Parks.

Name of a park	Coordinates	Area [ha]	Altitude [m]
Karađorđev park	45°23'12"N 20°23'54"E	5	76
Plankov park	45°22'39"N 20°23'24"E	0,75	76
Šećeranski park	45°21'54"N 20°24'38"E	8	76

In the Zrenjanin Parks, there is a systematic replacement of trees, the time of planting is taken into account, as well as the maintenance of the planting material, as well as the percentage of afforestation and the effects of greenery on the environment and human health. The public utility company "Čistoća i zelenilo" Zrenjanin performs the maintenance of public green areas on the territory of the City.

**Karađorđev Park** is the largest green oasis with an area of 50,000 m<sup>2</sup> near the center of Zrenjanin, where there are 1196 seedlings. It was established in 1954. The project Reconstruction of the park takes place in three phases, in the first phase of November 2022, 40 dilapidated trees were cut down, and 98 saplings of different types of deciduous trees (52) and 46 conifers were planted. In February 2023, another 75 seedlings were planted [10].

**Plankov Park** - Plankert, is the oldest park in the city center. It was created by the pharmacist Ferenc Franja Plank in 1834, on 16,000 m<sup>2</sup> on the left coast of Begej. He left his estate with a garden to the city. Due to the urban development of the city, the Park was reduced and today occupies an area of about 7,500 m<sup>2</sup>. Birch seedlings were planted in Plank's Garden in December 2019 as part of the "Green Week" campaign [10]. That was the beginning of the greening of the city of Zrenjanin, but most of the seedlings have completely dried up.

**Šećeranski Park** was formed after the construction of the Sugar Factory in 1910, when there was a need to build a protective green belt around the factory. Over time, this strip grew into the most spacious city park, which today covers an area of nearly 80,000 m<sup>2</sup> [10].

### Soil analysis

Non-agricultural soil samples - three selected Zrenjanin parks (Karađorđev, Plankov and Šećeranski) were sampled with a soil sampling probe from a depth of 0-20 cm in May 2023 (Fig.3). Soil samples from the layer of 0–20 cm were taken using Egner's stick. Because of the constrained sampling options in urban environments and the significant variability of urban soils compared to natural soils, when investigating the chemical properties of urban soils, a composite sample was collected. This composite sample essentially involves the random collection of soil with a higher number of repetitions. Collected samples were chemically analyzed by the Palintest SK 300® analyzer soil.



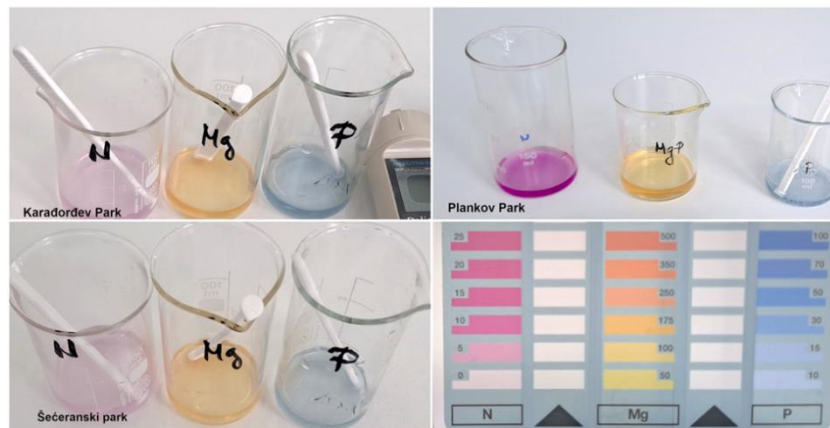
**Fig. 3.** Samples of non-agricultural land - Parks (Karađorđev, Šećeranski and Plankert)

Collected samples were chemically analyzed by the Palintest SK 300® soil analyzer [11], (Fig.4.).



**Fig.4.** Palintest SK 300® soil analyzer [ 11]

The Palintest Soiltester system uses blocks to color comparison. The Palintest Soiltester blocks are integrated with the Palintest range of soil extraction and reagent tablets, offer a simple colorimetric method of analysis for a range of important soil tests. Extraction of macronutrients (N, P, K, Mg, Ca) tests are carried out by first extracting the nutrients from the soil, and then testing the extracts by simple test procedures. The tests for nitrate and phosphate use colour comparison methods in conjunction with the N/P/Mg Soiltester block (Fig 5.)



**Fig. 5.** Colorimetric determination of nitrogen, magnesium and phosphorus content with the Palintest soil analyzer

The potassium test uses a simple procedure based on the amount of turbidity (cloudiness) formed in the sample, and the calcium test is based on the Palintest tablet count method. Tablets are added to a sample of the extract one at a time until the colour changes from pink to violet (Fig.6).

The amount of calcium is calculated according to the following formula:

$$\text{Calcium (mg/l)} = \text{Number of Tablets} \times 250$$





**Fig. 6.** Determination of calcium with the Palintest soil analyzer

The extraction procedure for the chemical analysis of various parameters with the Palintest soil analyzer is given in Table 2.

**Table 2.** Extraction procedure for chemical analysis of various parameters with the Palintest soil analyzer [11]

Test	Extract	Extract Chemical	Water [mL]	Soil sample [mL]
Soil pH	Extract W	Demineralized water	10	2
Lime Requirement	Extract W	Demineralized water	10	2
Conductivity	Extract W	Demineralized water	50	10
Nitrogen	Extract N	0,75 M ammonium chloride	50	2
Phosphorus	Extract P	0,5 M sodium bicarbonate	50	2
Calcium Magnesium	Extract A	1M Potassium chloride	50	10

After extraction, the sample is filtered to obtain a pure extract. It is not necessary to collect the entire amount of extract. About 10 mL of filtrate is required for most analyses.

### Determination of conductivity and pH value

The conductivity, pH-value and temperature of the soil solution are measured with a Palintest Conductivity Meter (Fig. 7). For assessing Electrical conductivity, the filtered extract is tested using a Palintest Conductivity Meter. This method provides a quick and simple means of comparing the conductivity or soluble salt content of different soil samples.



**Fig. 7.** Reading of soil conductivity and pH value

## Determination of calcium carbonate content

The determination of calcium carbonate is based on its destruction by mineral acids and the measurement of carbon dioxide, which is produced by that destruction. The chemical reaction of destruction of calcium carbonate by means of HCl is as follows [12]:



CaCO<sub>3</sub> is qualitatively determined by applying hydrochloric acid (10%) from a pipette to the soil. The appearance of bubbling with rustling is a sign that there is calcium carbonate in the soil (Fig 8).



**Fig. 8.** Determination of CaCO<sub>3</sub> content in the soil

## RESULTS AND DISCUSSION

The textural classification of the surface soil layer in the examined soils from three Zrenjanin parks predominantly indicated a loam texture, with the exception of park 3, where sandy loam was identified. Table 3 presents the obtained results for the fundamental chemical properties of the soil at specific locations within selected parks in the city of Zrenjanin. All chemical analyses were conducted in three repetitions, and the values in the table represent the mean values.

**Table 3.** Chemical composition of the soil in Zrenjanin Parks

THE MEAN VALUES OF THE TESTED PARAMETERS								
Name of a Park	pH value	CaCO <sub>3</sub> [%]	Nitrogen [mg/L]	Phosphorus [mg/L]	Potassium [mg/L]	Magnesium [mg/L]	Calcium [mg/L]	Conductivity [μS]
1. Karadordev Park	8,82	4	5	40	35	175	1500	69,2
2. Plankov Park	8,74	3	25	30	20	175	2000	69,3
3. Sečeranski Park	8,19	10	25	50	40	100	1500	38,2

Soil pH is important in determining the availability of plant nutrients. Investigations of the surface layers of the soil of the Zrenjanin parks showed that the reaction of the soil is weakly alkaline and that it is on average 8.58, that the content of the easily accessible form of phosphorus in the surface layers is in the range of 30-50 mg/ L, and the content of the easily accessible form of potassium in the range of 20-40 mg/ L. Similar results were obtained when it comes to soils in the parks of urban and industrial centers in Serbia (Belgrade, Pančevo, Smederevo, Obrenovac, Novi Sad), it was determined that alkaline soils predominate in which the pH values range in a narrow range (8.30-8.60) [13], and that the content of the easily accessible form of P in the surface layers is in the range of 4-30 mg/kg, and the content of the easily accessible form of K in the range of 9-40 mg/kg [3,8]. The soil conductivity in the samples collected from Zrenjanin city parks ranges from 38.2 to 69.2 μS at 25.2°C, suggesting that the soils are non-saline. Overall, the analyzed soils exhibited very

low salinity levels, with electrical conductivity ranging from 0.03 to 0.38 mS cm<sup>-1</sup> [1]. The soils in Zrenjanin parks also show adequate levels of nitrogen (5-25 mg/L), magnesium (100-175 mg/L), and calcium (1500-2000 mg/L), aligning with the findings of Kleiber and coauthors. [1]. The carbonate content in Zrenjanin city parks' soils varied from 3% to 10%, which closely matches the findings of Galić and fellow researchers [3], who reported a range of 4.55% to 14.91%.

## CONCLUSION

Based on the phosphorus content in the surface soil layers of the park soils, it can be concluded that they belong to the category of soils highly enriched with this element. The maximum concentration of potassium in the surface layers of park soils is determined by the content of the easily accessible form of potassium. Consequently, the surface layers of park soils, based on their potassium content, fall into the category of highly secure soils. Correlations were established for pH, lime requirement, nitrates (N), phosphates (P), potassium (K), and magnesium (Mg) using Palintest methods, and these results were similar to those obtained through standard laboratory soil testing methods.

The five main elements absorbed by plants from the soil, namely nitrogen (N), phosphorus (P), potassium (K), calcium (Ca), and magnesium (Mg), are considered macronutrients due to their significant role in plant growth. The Palintest SK 300 soil analyzer device has proven to meet expectations in terms of accuracy and speed when measuring the most critical chemical properties of the soil compared to traditional methods. Therefore, it is recommended for quick assessments of both agricultural and non-agricultural land quality. Furthermore, this study demonstrates that measuring the chemical properties of soil can be done in a straightforward manner, facilitating the evaluation of soil sample quality, which is of paramount importance.

## REFERENCES

- [1] Kleiber, T., Krzyżaniak M., Świerk D., Haenel A., Galecka S., How does the content of nutrients in soil affect the health status of trees in city parks?, PLOS ONE, <https://doi.org/10.1371/journal.pone.0221514>, September 11, 2019.
- [2] Effland, W. R., Pouyat, R., The genesis, classification and mapping of soils in a urban areas, Urban Ecosystems, vol 1. pp. 217-228, 1997.
- [3] Galić, Z., Pilipović, A., Orlović, S., Klašnja, B., Ivanišević, P., Kebert, M., Karakteristike zemljišta parkova u Novom Sadu i njihova opterećenost teškim metalima, Topola, No.181/182, pp. 11-20, 2008.
- [4] Djurdjev, B., Gradsko stanovništvo i mreža gradova, Stanovništvo i domaćinstva Srbije prema popisu 2002. godine., Republički zavod za statistiku Srbije, Institut društvenih nauka, Centar za demografska istraživanja pp.47-53, 2006.
- [5] Škorić, A., Filipovski, G., Ćirić, M., Klasifikacija zemljišta Jugoslavije, Akademija nauke i umjetnosti Bosne i Hercegovine, Sarajevo. 66 str., 1985.
- [6] Pickett, A.T.S., Cadenasso, M., Altered resources, disturbance and heterogeneity: A framework for comparing urban and non-urban soils., Urban Ecosystems, Vol. 12, pp. 23-44, 2009.
- [7] Pekeč, S., Marković, M., Kebert, M., Karaklić, V., Osobine zemljišta na području Futoškog parka u Novom Sadu, Šumarstvo, pp. 111-118, 2020.
- [8] Eremija, S., Miletić, Z., Mitrović S., Češljarić, Z., Ekološko-proizvodne karakteristike zemljišta u parkovima grada Beograda, Šumarstvo, No. 3-4, pp. 91-104, 2019.
- [9] Howard, J., Anthropogenic Soils, Springer International Publishing AG. <https://publikacije.stat.gov.rs/G1950/Pdf/G19502001.pdf>, 2017.
- [10] Grad Zrenjanin, <https://www.zrenjanin.rs/>, (Pristupljeno:12.06.2023.)
- [11] Palintest@SK 300, Soil Management Kit, Operation Manuel, [www.palintest.com](http://www.palintest.com)
- [12] Belić, M., Nešić, Lj., Ćirić, V., Praktikum iz pedologije, Novi Sad, Univerzitet u Novom Sadu, Poljoprivredni fakultet, 2014.

- [13] Pavlović, M., Pavlović D., Kostić, O., Jarić, S., Čakmak, D., Pavlović, P., Mitrović M. (2017b): Evaluation of urban contamination with trace elements in city parks in Serbia using pine (*Pinus nigra* Arnold) needles, bark and urban topsoil, *International Journal of Environmental Research*, Vol. 11(5-6), pp. 625-639, 2017b.





## CROSS-SECTION OF LAW ON ENVIRONMENTAL PROTECTION LEGAL REQUIREMENTS AND ISO 14001 REQUIREMENTS

Marija Perović<sup>1</sup>, David Mitrinović<sup>1</sup>, Marija Todorović<sup>1</sup>

<sup>1</sup>Jaroslav Černi Water Institute, Belgrade, Serbia

e-mail: [marija.perovic@jcemi.rs](mailto:marija.perovic@jcemi.rs)

**Abstract:** The legal framework that governs human actions that may have a negative effect on the environment and natural resources is indicated by the Law on Environmental Protection. The requirements outlined in Environmental protection laws are mandatory and obligatory for individuals, businesses, and organizations operating within the jurisdiction covered by this legal act and derived by-laws. Compliance with these laws is legally required, and failure to comply can result in penalties, fines, legal actions, or other sanctions, depending on the severity of the violation and the specific regulations in place. ISO 14001 -Environmental management systems, is a voluntary international standard developed by the International Organization for Standardization (ISO) to provide a framework for organizations to establish and operate an Environmental Management System (EMS). Although ISO 14001 is voluntary, organizations that choose to adopt it need to adhere to the requirements outlined in the standard to achieve and maintain certification. Compliance with ISO 14001 involves implementing and documenting an EMS based on the standard guidelines and principles. Within this research the cross-section of environmental legal requirements and ISO 14001 standard requirements is conducted. The study's objective is to show which requirements of the standard have already been met by conforming to the stipulations of the law.

**Key words:** ISO 14001, Law on Environmental Protection

### INTRODUCTION

Environmental responsibility entails conscientiously considering and minimizing the ecological impact of actions, fostering a harmonious relationship between human activities and the natural world, and ensuring a sustainable legacy for future generations. Adopting ISO 14001 shows a proactive approach to managing environmental impacts and continuously improving environmental performance, at the same time enhancing the organization's market competitiveness [1]. While ISO 14001 certification is not a legal requirement, it can help organizations ensure compliance with applicable environmental laws and regulations by providing a structured approach to environmental management. Improved efficiency and cost savings through enhanced resource efficiency, waste reduction, energy efficiency, and optimized processes, lead to financial benefits for organization. Certification can enhance an organization's reputation, demonstrating to stakeholders, including customers, employees, and investors, that the organization is committed to environmental protection. Within the ISO 14001 the general requirements for establishing an EMS, including aspects like environmental policy, planning, implementation, and operation, monitoring and measurement, and continual improvement, are outlined [2]. ISO 14001 places a strong emphasis on improving environmental performance, setting objectives and targets related to significant environmental aspects, and striving for continual improvement in an organization's environmental impact[3].

The Law on Environmental Protection ("Official Gazette of the RS", no. 135/2004, 36/2009, 36/2009 - other laws, 72/2009 - other laws, 43/2011 - US decision, 14/2016, 76/2018, 95 /2018 - other law and 95/2018 - other law) regulates the integral system of environmental protection, which ensures the realization of the human right to life and development in a healthy environment and a balanced relationship between economic development and the environment in the Republic of Serbia [4]. Within the Article 2 it is stated that the environmental protection system foreseen measures, conditions, and instruments for:

- sustainable management, preservation of natural balance, integrity, diversity and quality of natural values and conditions for the survival of all living beings.
- prevention, control, reduction, and remediation of all forms of environmental pollution.

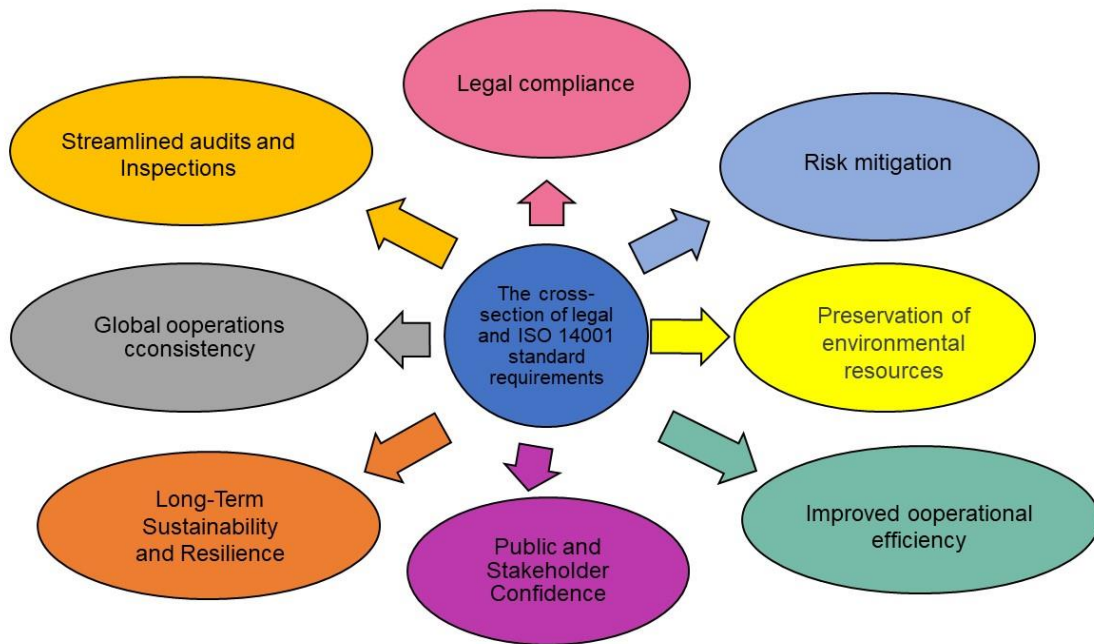
The eleven principles of environmental protection are listed within Article 9 of the Law on Environmental Protection. It encompasses the principles of integrity, prevention and precaution, preservation of natural values, sustainable development, responsibility of the polluter and his legal successor, the "polluter pays" principle, the "user pays" principle, the principle of subsidiary responsibility, principle of implementation of incentive measures, the principle of public information and participation, the principle of protection of the right to a healthy environment and access to justice.

The law mandates a thorough assessment of potential environmental impacts for certain projects and activities. An Environmental Impact Assessment (EIA) helps identify, predict, and mitigate adverse effects on the environment. Waste management (including collection, treatment, disposal, and recycling) and pollution control (limiting pollution from various sources) are also regulated by Law. The determined standards and requirements for maintaining the quality of water bodies and air are set with the aim of protecting public health and the environment. Legal provisions cover the sustainable use and conservation of natural resources, including water resources, forests, biodiversity, and minerals, to ensure their long-term availability and protection. Biodiversity conservation, establishing protected areas, protecting endangered species, and preserving natural habitats are also very important issues covered by law. Organizations and authorities are required to monitor and report on environmental parameters and compliance with environmental standards, providing transparency and accountability. The law includes provisions for enforcement, compliance monitoring, penalties for non-compliance, and legal actions against violators. Public participation and access to information present an important part of the law emphasizing the importance of public involvement in environmental decision-making processes and grant access to environmental information, fostering transparency and citizen engagement. For cross-border cooperation and international agreements the provisions outline cooperation with neighboring countries and adherence to international agreements related to environmental protection.

## **MATERIAL AND METHODS**

The cross-section analysis of the requirements of Law on Environmental Protection[4] and ISO 14001 requirements[3] was conducted. The results of comparison present a useful tool which allows the easier integration of ISO 14001 standard in business operations, while the law's obligations must be followed.

Aligning ISO 14001 requirements with environmental law requirements is crucial for organizations seeking to achieve effective environmental management and compliance. This alignment ensures that an organization's environmental management system (EMS) not only meets international standards but also complies with the specific legal obligations and regulatory framework of the country. The advantages highlighting the importance of this alignment are presented in Fig. 1.



**Fig. 1.** The overlap of the requirements of the Law on Environmental Protection with the requirements of the ISO 14001 standard

Aligning ISO14001 with environmental laws helps ensure that the organization's environmental practices and procedures are in full compliance with the legal requirements of the jurisdiction. This reduces the risk of legal issues, fines, sanctions, or operational disruptions due to non-compliance.

Understanding and integrating legal requirements into the EMS allows organizations to identify potential legal risks and liabilities associated with their operations. By addressing these risks within the EMS, organizations can proactively mitigate legal exposure and associated financial and reputational risks.

Compliance with environmental laws demonstrates a commitment to the preservation of environmental resources. Aligning ISO 14001 with these laws enhances an organization's ability to meet its environmental responsibilities, reduce its environmental impact, and contribute positively to the surrounding community and ecosystem.

Aligning with legal requirements often involves understanding the optimal use of resources, waste reduction, energy efficiency, and sustainable practices. By integrating these practices into the EMS, organizations can improve operational efficiency, reduce costs, and enhance resource management.

Demonstrating compliance with both ISO 14001 and environmental laws increases public confidence and trust. Stakeholders, including customers, investors, regulators, and communities, often expect organizations to uphold legal and international standards, and alignment helps meet those expectations.

By incorporating legal requirements into the EMS, organizations can better position themselves for long-term sustainability and resilience in a rapidly changing regulatory landscape. Adapting to legal changes promptly and effectively is crucial for the organization's ongoing success and competitiveness.

For organizations operating across multiple jurisdictions, aligning with both ISO 14001 and relevant environmental laws provides a consistent approach to environmental management. This consistency ensures that environmental objectives and practices are harmonized across various locations, aiding in a cohesive and standardized approach.

Aligning ISO 14001 with legal requirements facilitates smoother audits and inspections. When an organization's EMS aligns with the applicable legal framework, audits become more efficient, saving time and resources for both the organization and the auditing bodies.

## RESULTS AND DISCUSSION

Within Article 39 of the Law on Environmental Protection, the requirements in respect of environmental quality are stipulated. Limit values of the levels of pollutants, noise, radiation and energy and limit values of the emissions in the air, water, and soil, including the emission from mobile sources of pollution, shall be determined by the Government in compliance with special regulations. Within Clause 6 of ISO 14001, the Environmental aspects shall be determined. Environmental aspects are defined as an element of an organization's activities, products or services that may impact, or do impact, the environment. An environmental impact is a result of an environmental aspect. Organizations are required to determine the environmental aspects of their activities, products, or services that can interact with the environment. This would involve identifying how the organization's operations affect the environment and aligning these aspects with local environmental priorities and concerns. The list of recognized environmental aspects along with their evaluation will give confidence that the company, by meeting the requirements of ISO 14001 - Clause 6, meets the requirements of the Law.

Within Article 72 of the Law on Environmental Protection it is, among other, stated that an operator of the installation, i.e., of the establishment that is a source of emissions and environmental pollution shall be obliged to perform monitoring, in compliance with the law, through the competent authority, authorized organization or independently, providing that it complies with the legally prescribed conditions. This requirement coincides with the Environmental goals (Clause 6.2) and Environmental Policy (Clause 5.2), whose aim is providing the decrease of the negative impact and the indicators which will prove the decrease (Key performance indicator – Clause 9.1).

Article 102 states the ways that legal and natural people are obliged to provide the protection of the environment in conducting their activities. It emphasizes the need for: application and implementation of the regulations on environmental protection; sustainable use of natural resources, goods and energy; introduction of energy more efficient technologies and through the use of renewable natural resources; the use of products, processes, technologies and practice that jeopardize the environment less; taking preventive measures or removal of consequences of jeopardizing of and damage to the environment; maintenance of records in the prescribed manner and delivery thereof to the competent authorities; control of activities and operation of the installations that may present a risk or cause danger to the environment and human health; The requirements of this Article coincides with the Context of the organization (Clause 4) and Environmental policy (Clause 5.2) which proves the company's commitment to environmentally responsible business operations. The maintaining of the mentioned records corresponds to Clause 9.1 (Monitoring, Measurement, Analysis and Evaluation) and Clause 7.5. (Documented Information) of ISO 14001. Environmental Objectives and Planning to Achieve Them (ISO 14001 Clause 6.2) - ISO 14001, requires organizations to set environmental objectives and targets considering their significant environmental aspects and legal requirements. Organizations would align these objectives with the environmental goals outlined in national and regional environmental plans and policies.

Legal Compliance (Clause 6.1.4) of ISO 14001 requires organizations to establish and maintain procedures to identify and have access to legal and other requirements related to environmental aspects. In Serbia, this would involve aligning with the relevant national and regional environmental laws, regulations, and permits applicable to the organization's operations.

Resources, Roles, Responsibility, and Authority (Clause 7.1) of ISO 14001 states that an organization needs to define roles, responsibilities, and authorities for individuals involved in the EMS. This aligns with responsibilities outlined in environmental legislation.

## CONCLUSION

The Law on Environmental Protection in Serbia is mandatory and enforceable, applicable to all organizations operating in Serbia, regardless of their nature or size. ISO 14001 is a voluntary international standard that organizations can choose to adopt. While it's not a legal requirement, many organizations adopt it to improve their environmental performance, enhance their reputation, and potentially meet customer and stakeholder expectations. The Law on Environmental Protection provides specific legal requirements and regulations that organizations in Serbia must adhere to, whereas ISO 14001 offers a structured approach to environmental management based on a set of internationally recognized standards and guidelines. To ensure compliance with both the Law on Environmental Protection in Serbia and ISO 14001, organizations operating in Serbia may need to integrate the specific legal requirements into their EMS based on ISO 14001. This integration ensures alignment with both legal obligations and international best practices in environmental management. Aligning ISO 14001 requirements with environmental law requirements is a strategic approach that fosters legal compliance, operational efficiency, stakeholder trust, and long-term sustainability. It's an integral part of responsible and effective environmental management in today's business environment.

## Acknowledgment

This research was supported by Jaroslav Černi Water Institute.

## REFERENCES

- [1] Campos, L.M.S., Environmental management systems (EMS) for small companies: a study in Southern Brazil. *J. Clean. Prod.*,32,141-148, 2012.
- [2] Adyel, T. M., Begum, F. N., Islam, S. M. N., & Rahman, M. H., Assessment of Environmental Aspects and Impacts of Scientific Laboratories of a University: Focus on Gap Analysis and Environmental Management System (EMS) Implementation, *Jahangirnagar University Environmental Bulletin*, 2, 9-17 2013. <https://www.banglajol.info/index.php/JUEB/article/view/16325/11565>.
- [3] ISO 14001:2015 Environmental management systems.
- [4] Law on Environmental Protection ("Official Gazette of the RS", no. 135/2004, 36/2009, 36/2009 - other laws, 72/2009 - other laws, 43/2011 - US decision, 14/2016, 76/2018, 95 /2018 - other law and 95/2018 - other law).



## RECENT ADVANCES IN PHOTOCATALYTIC REMOVAL OF EMERGING PHARMACEUTICAL KETOPROFEN – A SHORT REVIEW

Mladenka Novaković<sup>1</sup>, Ivana Mihajlović<sup>1</sup>

<sup>1</sup>University of Novi Sad, Faculty of Technical Sciences, Novi Sad, Serbia

e-mail: [mladenkanovakovic@uns.ac.rs](mailto:mladenkanovakovic@uns.ac.rs)

**Abstract:** Pharmaceutical compounds, as well as their biologically active metabolites, continuously reach the aquatic environment in various ways, primarily through untreated or inadequately treated wastewater. The effectiveness of substance removal can vary according to the physical and chemical characteristics of drugs and the types of treatments used in wastewater treatment facilities. Ketoprofen (KP) is one of the most frequently detected micropollutants in different water media. As conventional treatments proved to be insufficient for the satisfactory removal of ketoprofen, the application of advanced technologies such as photocatalysis is necessary.

**Key words:** advanced oxidation processes, non-steroidal anti-inflammatory drugs, water media, photocatalysis

### INTRODUCTION

Over the past few decades, pharmaceutical contaminants have become more prevalent in the environment, particularly in water sources (drinking water, wastewater, surface water, and groundwater). Certain non-steroidal anti-inflammatory drugs (NSAIDs) are used more frequently than others due to their accessibility and safety. Ketoprofen (KP) is one of them whose consumption is estimated at 8.08 defined daily doses/1,000/d, meaning that 0.8 % of the population is receiving KP each day worldwide. According to studies, excessive exposure levels of ketoprofen may cause cytotoxicity and genotoxicity as well as a high risk of gastrointestinal issues[1].

Pharmaceuticals primarily enter waterways through insufficient wastewater treatment facilities, hospital and industrial discharges of wastewater, agriculture, animal husbandry, and soil washing. Considering the ineffectiveness of primary and secondary treatment for their removal, the design of the original municipal wastewater treatment plants mostly contributes to the discharge of pharmaceutical pollutants into the natural recipient. Physical and biological remediation procedures, which are referred to as the main and secondary phases in wastewater treatment plants, are the fundamental processes for eliminating organic and suspended components[2].

It is essential to develop effective and affordable technology to remove KP due to its complex aromatic composition. A sophisticated oxidation technique, photocatalysis has various benefits including ease of use, high efficacy, and low cost. It is frequently used to treat dyes, antibiotics, drugs, and other substances[3].

The aim of this study is to provide a comprehensive overview of the current state of application of different semiconductor material for photocatalytic removal of emerging contaminant ketoprofen in aquatic media.

### THE PRESENCE OF KETOPROFEN IN THE ENVIRONMENTAL MATRICES

Ketoprofen is a powerful and long-lasting anti-inflammatory, analgesic and antipyretic drug that belongs to the group of propionic acid derivatives. Until now, KP is a widely used non-steroidal anti-inflammatory drug in the world used for the treatment of rheumatoid arthritis, osteoarthritis, and other inflammatory disorders, which has better clinical outcomes than other common NSAIDs such as naproxen, ibuprofen, or diclofenac [4]. Different forms of

application of ketoprofen exist such as capsules, tablets and as preparations for the skin. The wide application of ketoprofen leads to a dominant intake in natural ecosystems. Ketoprofen has been shown to be ecotoxic by causing kidney damage in various species of organisms such as ungulates[5].

According to research (Prášková and associates, 2012), ketoprofen showed high acute toxicity for embryonic stages in Zebrafish (*Danio rerio*)[6]. Ketoprofen is defined as a photolabile pharmaceutical component, which upon direct exposure to sunlight in an aquatic medium is transformed into photoproducts such as 3-ethylbenzophenone [7]. The toxicity of ketoprofen increases 12-fold after exposure to sunlight causing the appearance of ketoprofen photoproduct toxicity [8].

Due to its wide application in the world, ketoprofen is often detected in high concentrations in influents. The highest concentration detected was up to 16.2 mg L<sup>-1</sup> in urban wastewater in northern Indian cities [9]. In other studies, from Italy, Portugal, Spain, Singapore and South Africa, was detected in wastewater at concentrations higher than of 1 mg L<sup>-1</sup>[10, 11, 12, 13, 14].

Hospital wastewater significantly contributes to the emission of pharmaceutical residues into aquatic ecosystems and environmental impact. It has been estimated that effluents from hospitals are five to fifteen times more toxic than classic city wastewater [12]. In this research, ketoprofen was detected at concentration levels of 1455 to 4233 ng L<sup>-1</sup> in a medium capacity Spanish hospital. In research Santos and associates, 2013, ketoprofen was detected in the influent of a wastewater treatment plant in the range of 289-589 ng L<sup>-1</sup> (mean 458 ng L<sup>-1</sup>), while it was detected in concentrations up to 3250 ng L<sup>-1</sup> (mean value 1107 ng L<sup>-1</sup>) in hospitals in Portugal[15]. In Italy, ketoprofen was detected at higher concentrations in hospital 0.83-9.8 mg L<sup>-1</sup> than in municipal wastewater of 0.13-0.19 mg L<sup>-1</sup>[16].

Numerous studies have shown that the concentration levels of ketoprofen in treated wastewater are significantly lower than the levels detected in influents, which are in nanogram levels. However, summarizing the results of individual studies, Dasenaki and Thomaidis, 2015; Madikizela and associates, 2014, it can be concluded that ketoprofen was detected in treated municipal waters, while according to other studies in the highest concentrations was found in the effluents reaching several mg L<sup>-1</sup>, which indicates the inadequacy of the plant to completely remove them[17, 18, 19, 20, 21].

In the pan-European region, ketoprofen was detected at a maximum concentration of 2.9 mg L<sup>-1</sup> in groundwater[21].

Conventional wastewater treatment is based on the application of activated sludge systems, where sorption to solid particles is the main mechanism for the removal of pharmaceuticals. Some pollutants can be transported from the aquatic phase to the sludge. By applying municipal sludge for agricultural purposes as soil amendments or fertilizers, pharmaceutical residues from the sludge spread to the terrestrial environment, contaminating the food chain or water supply [22]. Hydrophobic polar chemicals tend to sorb onto sludge. Some polar substances with specific sorption characteristics can appear in plant sludge in high concentrations due to the interaction of their polar functional groups (amines and aldehydes) with suspended organic material.

Studies in Portugal, China and Korea, respectively, showed that ketoprofen is the dominant contaminant in sludge at high concentrations (up to 21989 ng g<sup>-1</sup>) and the frequency of detection was up to 100%[21, 23, 24]. In the study, Verlicchi and Zambello, 2015, different concentrations of ketoprofen were detected in different types of fresh and treated sludge such as: primary, secondary, digested, mixed, dry, conditioned sludge[25]. Variations in residual levels of ketoprofen in sludge appear due to different wastewater treatments. More detailed studies should be conducted to explain the distribution of ketoprofen as a pharmaceutical contaminant in the solid/liquid system.

Several studies have confirmed the presence of ketoprofen in recycled water. The highest concentration was 211 ng L<sup>-1</sup> with a mean detection of 24 %. The study, Luand associates, 2016, investigated the distribution of ketoprofen residues in municipal waste landfill leachate. As mentioned, the presence of drugs in landfill leachate is explained by the disposal of



expired pharmaceuticals or unwanted products, which increases the risk of groundwater and soil degradation. In the study, the removal efficiency of ketoprofen in leachate treatment was not stated, so this component was detected in leachate from 32.9 to 159.6 ng L<sup>-1</sup>[26].

## LITERATURE REVIEW IN THE FIELD OF PHOTOCATALYTIC DEGRADATION OF KETOPROFEN

In the paper, Djouadi and associates, 2018, the photocatalysis of ketoprofen was investigated using the formed Bi<sub>2</sub>S<sub>3</sub>/TiO<sub>2</sub>-montmorillonite (Bi<sub>2</sub>S<sub>3</sub>/TiO<sub>2</sub>-Mt) by UV-VIS radiation. The initial concentration of ketoprofen was 15 mg L<sup>-1</sup>, while the concentration of the photocatalyst was 0.5 g L<sup>-1</sup>. The suspension was stirred in the dark for 30 minutes to achieve adsorption-desorption equilibrium. The duration of the photocatalytic process was 120 minutes. Degradation kinetics followed the Langmuir-Hinshelwood kinetic model. Factors influencing the kinetics of the photocatalytic process were investigated, such as the Bi<sub>2</sub>S<sub>3</sub>/TiO<sub>2</sub> ratio and the pH value of the solution. The maximum degradation efficiency was achieved in an alkaline medium at pH 11 and in the ratio 75:25 Bi<sub>2</sub>S<sub>3</sub>/TiO<sub>2</sub>. The degree of mineralization was low, 16% according to a certain share of the total organic carbon, which indicates the need to extend the treatment[27].

In the work, Martínez and associates, 2013, the degradation of ketoprofen was carried out using UV-VIS radiation with synthesized titanium dioxide TiO<sub>2</sub>, anatase form, a composite of multi-walled carbon nanotubes (20-MWCNT-TiO<sub>2</sub>) and commercial anatase. Various operational parameters were investigated such as: radiation source, initial ketoprofen concentration, solution pH, dissolved oxygen concentration and other factors. The fastest degradation of ketoprofen was recorded with a rate constant of  $(42 \pm 3) \times 10^{-4} \text{ s}^{-1}$  using UV irradiation with a 20-MWCNT-TiO<sub>2</sub> concentration of 1.2 g L<sup>-1</sup>. The 20-MWCNT-TiO<sub>2</sub> composite without the presence of oxygen enabled the fastest degradation of ketoprofen with a degradation rate constant of  $(13.6 \pm 0.7) \times 10^{-4} \text{ s}^{-1}$ . In this case, 60% mineralization was achieved after 30 minutes of treatment[28].

Sacco and associate, 2020, synthesized a new Pt-TiO<sub>2</sub>-Nb<sub>2</sub>O<sub>5</sub> photocatalyst and the photocatalytic degradation of diclofenac and ketoprofen was investigated under UV light. The optimal rate of mineralization of diclofenac and ketoprofen was 0.0555 and 0.0746 min<sup>-1</sup>, which is much higher compared to the Pt-TiO<sub>2</sub> photocatalyst (0.0321 min<sup>-1</sup> for diclofenac and 0.0597 min<sup>-1</sup> for ketoprofen). The duration of the photocatalytic process was 60 minutes, while the concentration of diclofenac and ketoprofen was 12.5 mg L<sup>-1</sup> and the concentration of the photocatalyst was 0.5 g L<sup>-1</sup>[29].

In work, Zhu and associates, 2019, a new catalyst was formed from carbon dots (C dots) doped with metal organic cross-linked structures (MOF), UiO-66-NH<sub>2</sub> to evaluate the efficiency of photocatalytic degradation of ketoprofen at a concentration of 25 mg L<sup>-1</sup> in a 0.4 mg mL<sup>-1</sup> concentration of (C-dots/UiO-66-NH<sub>2</sub>) nanocomposite. After 60 minutes of treatment with the newly formed nanocomposite, 92% of ketoprofen was degraded[30].

The paper, Paganini and associates, 2019, examined the photocatalytic activity of zinc oxide ZnO doped with different ratios of iron (0.5, 1, 3 % Fe). The initial concentration of ketoprofen was 20 mg L<sup>-1</sup> with a catalyst concentration of 1000 mg L<sup>-1</sup> and 400 mg L<sup>-1</sup>. The efficiency of the photocatalytic degradation of ketoprofen was investigated for ultrapure water and wastewater from a wastewater treatment plant. Complete removal of ketoprofen was achieved with Fe(0.5 %)-ZnO-H. All photocatalytic degradation products were completely mineralized after 30 minutes of the process[31].

Heterojunction photocatalyst Ag/NH<sub>2</sub>-MIL-125(Ti)/CdS (AMC-5, AMC-10 and AMC-20) was examined for ketoprofen removal in study of Zheng and associates, 2022. The highest surface area was shown for AMC-10 (363.41 m<sup>2</sup>/g). At initial concentration of 10 mg/L, 94.2% of ketoprofen is transformed to intermediates in period of 180 min. The rate constant was 0.0168 min<sup>-1</sup>, which is significantly higher than in the case of the use of individual photocatalysts, CdS and NH<sub>2</sub>-MIL-125(Ti). The degree of mineralization of ketoprofen expressed as a percentage of total organic carbon removal was 57.5%[3].

In research study, Szymanski and associates, 2022, submerged photocatalytic membrane reactor (SPMR) in combination with titanium dioxide was used for degradation of ketoprofen. As an experimental water media, surface and secondary municipal wastewater were used. The experimental parameters were 10 mg/L and 5h for ketoprofen and irradiation time, respectively. The type of water media had significant impact on TOC removal rate (ranging from 19 to 56%)[32].

The detailed study was conducted in paper Kumar Ray and associates, 2023. A newly developed heterostructure ZnFe<sub>2</sub>O<sub>4</sub> nanosphere-decorated α-NiMoO<sub>4</sub> nanorods on coffee biochar (BC), was fabricated via a hydrothermal method and used for ketoprofen removal. As irradiation source, visible light was explored. Selected photocatalyst shown significant potential in removal of ketoprofen in a period of 180 min (removal rate 98.65%). The impacts of operational factors: pH (3, 6.5, and 10) anions (Cl<sup>-</sup>, NO<sub>3</sub><sup>-</sup>, and SO<sub>4</sub><sup>2-</sup>), and different concentrations of ketoprofen (5, 10, and 15 mg L<sup>-1</sup>) and photocatalyst (0.05 g, 0.1 g, and 0.15 g) were investigated. With increasing pH, KP's photocatalytic decomposition rate accelerated. Strong interactions between the pollutant and the active sites of the photocatalyst at the optimal KP concentration (10 mg L<sup>-1</sup>) may result in the production of a greater number of active species. The photocatalytic degradation rate of KP increased with increasing NM/ZF/BC dosages (0.05 g: 77.05% and 0.1 g: 98.65%) until the optimum dosage (0.1 g) was attained [1].

The summarized information about analyses studies is shown in Table 1.

**Table 1.** Review of studies on the photocatalytic degradation of ketoprofen

<b>Water matrices</b>	<b>Irradiation source</b>	<b>Photocatalyst</b>	<b>Process parameters</b>	<b>Reference</b>
Deionized water	Medium pressure mercury lamp ( $\lambda_{exc} = 254 - 578$ nm)	Bi <sub>2</sub> S <sub>3</sub> /TiO <sub>2</sub> (25/75)-montmorillonite nanocomposite	$t=120$ min $c_0=15$ mg L <sup>-1</sup> $c_c=0,50$ g L <sup>-1</sup> pH 3-11	[27]
Deionized water	Medium pressure mercury lamp ( $\lambda_{exc} = 254 - 578$ nm)	20-MWCNT-TiO <sub>2</sub>	$t=120$ min $c_0=59$ mM $c_k = 1,2$ g L <sup>-1</sup> $C_{H_2O_2}=1-6$ mM	[28]
Deionized water	UV-LEDs lamp ( $\lambda_{max} = 365$ nm)	Pt-TiO <sub>2</sub> -Nb <sub>2</sub> O <sub>5</sub>	$t=60$ min $c_0=12,5$ mg L <sup>-1</sup> $c_c=0,5$ g L <sup>-1</sup>	[29]
Deionized water	VIS ( $\lambda_{max}=420$ nm)	C-dots/UiO-66-NH <sub>2</sub>	$t=60$ min $c_0= 25$ mg L <sup>-1</sup> $c_c=0,4$ g mL <sup>-1</sup>	[30]
Deionized water Wastewater	6 × 15 W UV reactor ( $\lambda_{max}= 365$ nm)	Fe doped with ZnO	$t=120$ min $c_0=20$ mg L <sup>-1</sup> $c_k= 1000$ mg L <sup>-1</sup> i	[31]

			400 mg L <sup>-1</sup>	
Deionized water	The Xenon lamp (350 W)	Ag/NH <sub>2</sub> -MIL-125(Ti)/CdS	t=180 min c <sub>0</sub> =10 mgL <sup>-1</sup> c <sub>c</sub> = 0.5 mg/mL	[3]
Sea water, Brackish water, Surface water, Municipal wastewater	UV-A light (2 lamps Philips CLEO iSOLde, (λ <sub>max</sub> = 355 nm).	TiO <sub>2</sub>	t=5 h c <sub>0</sub> =10 mgL <sup>-1</sup> m <sub>c</sub> = 0.05 g, 0.1 g, and 0.15 g pH 3, 6.5 and 10	[32]
Deionized water	VIS	α-NiMoO <sub>4</sub> /ZnFe <sub>2</sub> O <sub>4</sub> /coffee biochar	t=180 min c <sub>0</sub> =5, 10, and 15 mgL <sup>-1</sup>	[1]

## CONCLUSION

One of the most prevalent organic micropollutants recently found in environmental media at low concentration levels are pharmaceutical synthetic substances. It is necessary to use more advanced methods for wastewater treatment to improve the quality of the final recipient due to the complexity of non-steroidal anti-inflammatory drugs (NSAIDs) and their insufficient elimination by traditional wastewater treatment. The studies that were cited indicate that there is a large potential for the degradation of ketoprofen in the use of various materials in the photocatalytic process. Additional research should focus on the material's use in multiple cycles and the layout of the photocatalytic system (use of suitable photoreactors), which could promote the application's cost-effectiveness in practical wastewater treatment plants.

## ACKNOWLEDGMENT

This research (paper) has been supported by the Ministry of Science, Technological Development and Innovation through project no. 451-03-47/2023- 01/200156 "Innovative scientific and artistic research from the FTS (activity) domain".

## REFERENCES

- [1] Kumar Ray, S., Kumar Reddy Pa, A., Yoon, S., Shin, J., Chon, K., Sungjun Bae, S., A magnetically separable α-NiMoO<sub>4</sub>/ZnFe<sub>2</sub>O<sub>4</sub>/coffee biochar heterojunction photocatalyst for efficient ketoprofen degradation, *Chemical Engineering Journal*, No. 452, pp.139546, 2023.
- [2] Zhuo, N., Lan, Y.Q., Yang, W.B., Yang, Z., Li, X.M., Zhou, X., Liu, Y., Shen, J.C., Zhang, X. T., Adsorption of three selected pharmaceuticals and personal care products (PPCPs) onto MIL-101(Cr)/natural polymer composite beads, *Separation and Purification Technology*, No.177, pp. 272–280, 2017.

- [3] Zheng, X., Li, Y., Yang, J., Cui S., Z-Scheme heterojunction Ag/NH<sub>2</sub>-MIL-125(Ti)/CdS with enhanced photocatalytic activity for ketoprofen degradation: Mechanism and intermediates, *Chemical Engineering Journal*, No. 422, pp.130105, 2021.
- [4] Sarzi-Puttini, P., Atzeni, F., Lanata, L., Bagnasco, M., Efficacy of ketoprofen vs. ibuprofen and diclofenac: A systematic review of the literature and meta-analysis. *Clinical and Experimental Rheumatology*, No. 31, pp. 731–738, 2013.
- [5] Palviainen, M.J., Junnikkala, S., Raekallio, M., Meri, S., Vainio, O., Activation of complement system in kidney after ketoprofen-induced kidney injury in sheep, *Acta Veterinaria Scandinavica*, No. 57, pp. 2–7, 2015.
- [6] Prášková, E., Štěpánová, S., Chromcová, L., Plhalová, L., Voslářová, E., Pištěková, V., Prokeš, M., Svobodová, Z., The effects of subchronic exposure to ketoprofen on early developmental stages of common carp. *Acta Veterinaria Brno* No. 82, pp. 343–347, 2013.
- [7] Hanamoto, S., Hasegawa, E., Nakada, N., Yamashita, N., Tanaka, H., Modeling the fate of a photoproduct of ketoprofen in urban rivers receiving wastewater treatment plant effluent, *Science of Total Environment*, No. 573, pp. 810–816, 2016.
- [8] Hanamoto, S., Kawakami, T., Nakada, N., Yamashita, N., Tanaka, H., Evaluation of the photolysis of pharmaceuticals within a river by 2 year field observations and toxicity changes by sunlight, *Environmental Science: Processes & Impacts* No. 16, pp. 2796–2803, 2014
- [9] Singh, K.P., Rai, P., Singh, A.K., Verma, P., Gupta, S., Occurrence of pharmaceuticals in urban wastewater of north Indian cities and risk assessment, *Environmental Monitoring and Assessment*, No.186, pp. 6663–6682, 2014.
- [10] Verlicchi, P., Al Aukidy, M., Zambello, E., Occurrence of pharmaceutical compounds in urban wastewater: Removal, mass load and environmental risk after a secondary treatment-A review, *Science of Total Environment*, No. 429, pp.123–155, 2012a.
- [11] Salgado, R., Noronha, J.P., Oehmen, A., Carvalho, G., Reis, M.A.M., Analysis of 65 pharmaceuticals and personal care products in 5 wastewater treatment plants in Portugal using a simplified analytical methodology. *Water Science and Technology*, No. 62, pp. 2862-71, 2010.
- [12] Mendoza, A., Aceña, J., Pérez, S., López de Alda, M., Barceló, D., Gil, A., Valcárcel, Y., Pharmaceuticals and iodinated contrast media in a hospital wastewater: A case study to analyse their presence and characterise their environmental risk and hazard, *Environmental Research*, No.140, pp. 225–241, 2015.
- [13] Tran, N.H., Hu, J., Ong, S.L., Simultaneous determination of PPCPs, EDCs, and artificial sweeteners in environmental water samples using a single-step SPE coupled with HPLC-MS/MS and isotope dilution, *Talanta*, No. 113, pp. 82–92, 2013.
- [14] Agunbiade, F.O., Moodley, B., Occurrence and distribution pattern of acidic pharmaceuticals in surface water, wastewater, and sediment of the Msunduzi River, Kwazulu-Natal, South Africa, *Environmental Toxicology and Chemistry* No. 35, pp. 36–46. 2016.
- [15] Santos, L.H.M.L.M., Araújo, A.N., Fachini, A., Pena, A., Delerue-matos, C., Montenegro, M.C.B.S.M., Ecotoxicological aspects related to the presence of pharmaceuticals in the aquatic environment, *Journal of Hazardous Materials*, No.175, pp. 45–95, 2010.
- [16] Verlicchi, P., Al Aukidy, M., Galletti, A., Petrovic, M., Barceló, D., Hospital effluent: Investigation of the concentrations and distribution of pharmaceuticals and environmental risk assessment, *Science of Total Environment*, No. 430, pp. 109–118, 2012b.
- [17] Dasenaki, M.E., Thomaidis, N.S., Multianalyte method for the determination of pharmaceuticals in wastewater samples using solid-phase extraction and liquid chromatography-tandem mass spectrometry. *Analytical and Bioanalytical Chemistry*. No. 407, pp 4229–4245, 2015.
- [18] Madikizela, L.M., Muthwa, S.F., Chimuka, L., Determination of triclosan and ketoprofen in river water and wastewater by solid phase extraction and high

- performance liquid chromatography. *South African Journal of Chemistry*, No. 67, pp. 143–150, 2014.
- [19]Camacho-Muñoz, D., Martín, J., Santos, J.L., Aparicio, I., Alonso, E., Concentration evolution of pharmaceutically active compounds in raw urban and industrial wastewater, *Chemosphere*, No. 111, pp. 70–79, 2014.
- [20]Kermia, A.E.B., Fouial-Djebbar, D., Trari, M., Occurrence, fate and removal efficiencies of pharmaceuticals in wastewater treatment plants (WWTPs) discharging in the coastal environment of Algiers, *Comptes Rendus Chimie*, No.19, pp. 963–970, 2016.
- [21]Loos, R., Carvalho, R., António, D.C., Comero, S., Locoro, G., Tavazzi, S., Paracchini, B., Ghiani, M., Lettieri, T., Blaha, L., Jarosova, B., Voorspoels, S., Servaes, K., Haglund, P., Fick, J., Lindberg, R.H., Schwesig, D., Gawlik, B.M., EU-wide monitoring survey on emerging polar organic contaminants in wastewater treatment plant effluents, *Water Research*, No. 47, pp. 6475–6487, 2013.
- [22]Chen, Y., Yu, G., Cao, Q., Zhang, H., Lin, Q., Hong, Y., Occurrence and environmental implications of pharmaceuticals in Chinese municipal sewage sludge. *Chemosphere*, No. 93, pp. 1765–1772, 2013.
- [23]Salgado, R., Pereira, V.J., Carvalho, G., Soeiro, R., Gaffney, V., Almeida, C., Cardoso, V.V., Ferreira, E., Benoliel, M.J., Ternes, T.A., Oehmen, A., Reis, M.A.M., Noronha, J.P., Photodegradation kinetics and transformation products of ketoprofen, diclofenac and atenolol in pure water and treated wastewater, *Journal of Hazardous Materials*, No. 244–245, pp. 516–527, 2013.
- [24]Subedi, B., Lee, S., Moon, H.B., Kannan, K., Emission of artificial sweeteners, select pharmaceuticals, and personal care products through sewage sludge from wastewater treatment plants in Korea, *Environment International*, No. 68, pp. 33–40, 2014.
- [25]Verlicchi, P., Zambello, E., Pharmaceuticals and personal care products in untreated and treated sewage sludge: Occurrence and environmental risk in the case of application on soil - A critical review. *Science of Total Environment*, No. 538, pp. 750–767, 2015.
- [26]Lu, M.C., Chen, Y.Y., Chiou, M.R., Chen, M.Y., Fan, H.J., Occurrence and treatment efficiency of pharmaceuticals in landfill leachates, *Waste Management*, No. 55, pp. 257–264, 2016.
- [27]Djouadi, L., Khalaf, H., Boukhatem, H., Boutoumi, H., Kezzime, A., Santaballa, J.A., Canle, M., Degradation of aqueous ketoprofen by heterogeneous photocatalysis using Bi<sub>2</sub>S<sub>3</sub>/TiO<sub>2</sub>-Montmorillonite nanocomposites under simulated solar irradiation. *Applied Clay Science*, No. 166, pp. 27–37, 2018.
- [28]Martínez, C., Vilariño, S., Fernández, M.I., Faria, J., Canle, M.L., Santaballa, J.A., Mechanism of degradation of ketoprofen by heterogeneous photocatalysis in aqueous solution, *Applied Catalysis B: Environmental*, No. 142–143, pp. 633–646, 2013.
- [29]Sacco, O., Murcia, J.J., Lara, A.E., Hernández-Laverde, M., Rojas, H., Navío, J.A., Hidalgo, M.C., Vaiano, V., Pt-TiO<sub>2</sub>-Nb<sub>2</sub>O<sub>5</sub> heterojunction as effective photocatalyst for the degradation of diclofenac and ketoprofen, *Materials Science in Semiconductor Processing*, No. 107, 2020.
- [30]Zhu, G., Feng, Sheng, Feng, Shanshan, Zhang, Z., One-pot synthesis of C-dots/UiO-66-NH<sub>2</sub> with enhanced photocatalytic activity for degrading ketoprofen, *Materials Letters*, No. 246, pp. 36–39, 2019.
- [31]Paganini, M.C., Giorgini, A., Gonçalves, N.P.F., Gionco, C., Bianco Prevot, A., Calza, P., New insight into zinc oxide doped with iron and its exploitation to pollutants abatement, *Catalyst Today*, No. 328, pp. 230–234, 2019.
- [32]Szymansky, K., Gryta, M., Darowna, D., Mozia, S., A new submerged photocatalytic membrane reactor based on membrane distillation for ketoprofen removal from various aqueous matrices, *Chemical Engineering Journal*, No. 435, pp. 134872, 2022.



## THE DISTRIBUTION OF CD AND PB BETWEEN THE INTERMEDIATE AND FINAL SINKS IN COMPOSTING AND ANAEROBIC DIGESTION PROCESSES

Xiaoming Wang<sup>1</sup>, Nikolina Tošić<sup>2</sup>, Marko Muhadinović<sup>3</sup>, Tijana Marinković<sup>2</sup>,  
Srđan Kovačević<sup>2</sup>, Nemanja Stanisavljević<sup>2</sup>

<sup>1</sup>Department of Environmental Engineering, Chongqing University, Chongqing, China

<sup>2</sup>University of Novi Sad, Faculty of Technical Sciences, Department of Environmental Engineering, Novi Sad, Serbia

<sup>3</sup>Lafarge, BFC doo, Trg Beočinske fabrike cementa 1, Beočin, Serbia  
e-mail: [nikolina.tosic@uns.ac.rs](mailto:nikolina.tosic@uns.ac.rs)

**Abstract:** The anthroposphere maintains ongoing interactions with the environment, and as a result, waste management systems function as a filter designed to prevent the uncontrolled release of harmful substances into the air, water, and soil. The significance of waste management systems as a protective barrier between the anthroposphere and the environment is growing substantially in contemporary society due to heightened levels of production and consumption across all sectors. In this paper, the difference between the technologies of treating biodegradable waste will be presented as well as their impact on the anthroposphere. With the aim of avoiding the direct disposal of biodegradable waste in landfills, and its redirection and treatment, two technologies were presented, namely composting and anaerobic digestion.

**Key words:** composting, anaerobic digestion, quality, final sink, intermediate sink

### INTRODUCTION

As an integral part of the EU accession negotiations, the Republic of Serbia has initiated the development of a waste management system and its alignment with the objectives and regulations of the European Union, as outlined in Chapter 27, according to *Waste management program of the Republic of Serbia for the period 2022-2031* [1]. The objective is to decrease the disposal of biodegradable waste in landfills, with a target of achieving a reduction to 75% of the total biodegradable waste generated in 2008 by the year 2028. The ultimate aim is to further reduce this to 50% by the end of 2032 and ultimately to 35% by the close of 2039. Despite the full infrastructure for biodegradable waste diversion being expected to be in place by 2037, there is an anticipated adjustment period for these systems to meet the required standards.

In the design of an integrated waste management system, the following objectives have been embraced for comprehensive solid waste management: (1) *Protection of Human Health and the Environment*: The foremost goal is to safeguard both people and the environment from the potential harm posed by waste materials; (2) *Resource Conservation*: The system aims to preserve valuable resources like materials, energy and land, promoting sustainability and responsible resource management; (3) *Aftercare-Free Waste Treatment*: The system is designed to minimize or eliminate the need for ongoing aftercare or maintenance, ensuring that waste treatment processes are self-sustaining and require minimal intervention over time.

Hazardous organic materials find their final sink through transformation processes like waste-to-energy and various physical-chemical treatments. On the other hand, hazardous inorganic materials can be disposed of either through transformation processes or through safe deposits such as well-managed, long-term landfills with ongoing maintenance. These disposal methods can also be categorized as either natural (involving water, sediments, air, and soil) or anthropogenic (human-made) sinks [2].

Cadmium and lead, when improperly managed in waste disposal, pose significant environmental risks. These heavy metals are persistent and toxic, causing soil and water contamination. Cadmium and lead can leach into the ground, potentially infiltrating groundwater, and can also enter the food chain, posing health risks to humans and wildlife. Inadequate waste management practices can result in the release of these toxic substances, emphasizing the critical importance of proper final disposal and recycling methods to mitigate their adverse effects on the environment.

The aim of the paper is to show how biodegradable waste can be managed in a better way and to point out the very impact of Cd and Pb on the environment.

## **MATERIAL AND METHODS**

The basis for the quantities of biodegradable waste in the Republic of Serbia, as projected in the 2014 IMG study, is the expectation that the entire infrastructure for diverting such waste will be fully operational by 2037[3].

In 2020, as per information provided by the Environmental Protection Agency in the Republic of Serbia, only 19% of the waste collected and discarded was sent to sanitary landfills, with the majority being directed to unsanitary landfills. Additionally, the recycling rate for that year stood at a modest 15.45%, indicating a relatively low level of recycling activity[4].

To minimize the amount of biodegradable waste sent to landfills and mitigate its adverse effects during decomposition, it is advisable to utilize one of the suggested technologies for biodegradable waste treatment.

Below is more detailed information on the technologies applied to the treatment of biodegradable waste.

### **Composting process**

Windrow composting is a widely used method for large-scale composting of organic materials. It is a managed microbial aerobic process that allows for efficient decomposition of organic matter into nutrient-rich compost[5]. Organic materials are arranged in long, narrow rows called "windrows" or "composting piles." These composting piles are usually placed on a prepared pad or platform to facilitate aeration and drainage. Regular turning or flipping of the windrows is necessary to provide oxygen to the microorganisms responsible for decomposition. This turning also helps in mixing the materials thoroughly, promoting uniform decomposition and preventing the formation of anaerobic zone parts.

To effectively manage and optimize the composting process, it is necessary to monitor several key indicators and parameters[6]. These indicators help ensure that composting is proceeding correctly and that the final compost product meets quality and safety standards. Here are some essential indicators to monitor:

- *Temperature*: Composting generates heat as microorganisms break down the organic matter. To maximize microbial diversity, temperatures should ideally range between 25 and 45°C, while the highest biodegradation rates occur between 45 and 55°C. When the temperature falls below 20°C, microbial activity diminishes, and temperatures exceeding 55°C are optimal for pathogen inactivation. High temperature helps kill pathogens and weed seeds, while temperatures rarely surpass approximately 80°C, which also marks the point at which biological activity effectively ceases.
- *Moisture Content*: Maintaining the right moisture level is essential. Compost material typically should have around 50-60% moisture content. Too much or too little moisture can impede decomposition.
- *Carbon-to-Nitrogen (C/N) ratio*: The optimum C/N ratio for most types of wastes is about 25-30. An excessively high C/N ratio can impede the microbial decomposition process, while an excessively low C/N ratio can lead to the release of nitrogen in the form of ammonia.



- *pH levels*: The ideal pH range falls between 7 and 8. Throughout the composting process, pH tends to rise as a result of the breakdown and evaporation of organic acids.
- *Oxygen content & Aeration*: Oxygen levels should be monitored to ensure that there is adequate airflow within the compost pile. Insufficient oxygen can lead to anaerobic conditions, resulting in foul odors and inefficient decomposition. It is advisable to allocate a minimum of 20-30% free space to ensure an ample oxygen supply to the waste.

### **Anaerobic digestion process**

The anaerobic digestion of municipal solid waste is a carefully managed process involving the microbial decomposition of organic matter in the absence of oxygen. In this controlled environment, a community of microorganisms collaborates to transform organic materials into methane, carbon dioxide, inorganic nutrients, and humus.

The anaerobic biological process encompasses several fundamental pathways for breaking down complex organic compounds into methane and carbon dioxide. These pathways include depolymerization, fermentation, acetogenesis, and methanogenesis.

To effectively manage and optimize the anaerobic digestion process, it is necessary to monitor several key indicators and parameters:

- *Temperature*: Temperature has a significant role in influencing both the rate of biodegradation and biogas production in anaerobic digestion processes. Within the temperature range of 40-60°C, thermophilic bacteria are the dominant microorganisms in the digester. In contrast, at temperatures ranging from 25-40°C, mesophilic bacteria are more prevalent. It has been observed that as the temperature in the thermophilic range increases, the required residence time decreases.
- *C/N ratio*: During anaerobic digestion, microorganisms consume carbon at a rate approximately 20 to 30 times faster than they consume nitrogen. This indicates that an optimal carbon-to-nitrogen (C/N) ratio within the substrate falls in the range of 20-30:1. However, to ensure an effective biogas production process, a C/N ratio of at least 35-40 is typically recommended. This balanced ratio helps promote efficient microbial activity and the breakdown of organic matter into biogas.
- *pH levels*: Easily degradable substrates tend to undergo rapid acidification, leading to a noticeable decrease in pH. Methane-producing bacteria are negatively affected when the pH drops below 6.2. In an anaerobic digester, the pH initially decreases due to the production of volatile acids. However, as methane-forming bacteria consume these volatile acids and produce alkalinity, the pH gradually increases and eventually stabilizes. This pH stabilization is a crucial aspect of maintaining the efficiency and stability of the anaerobic digestion process.
- *Retention time*: The necessary retention time for the completion of anaerobic digestion reactions varies depending on the specific technology used, the process temperature, and the composition of the waste. For wastes treated in mesophilic digesters, the retention time typically falls within the range of 10 to 40 days. This range ensures that the AD process can effectively break down organic materials and generate biogas, but the exact duration may vary based on specific conditions and goals.

### **Material flow analysis and substance flow analysis**

Material flow analysis constitutes a methodical evaluation of material flows and stocks within a specific spatiotemporal system. Due to the law of conservation of matter, the findings of an MFA can be managed through a straightforward material balance that compares all inputs, stocks, and outputs within a given process[7]. Substance flow analysis lacks comprehensive and reliable information unless it is built upon a strong foundation in material flow

analysis. This paper was conducted using the STAN software [8], which facilitates both material flow analysis and substance flow analysis while also considering the uncertainties associated with data.

### Developed scenarios

Selecting processes when designing a waste management system is of significant importance, as these processes and their interactions are the cornerstone of defining the waste management framework. The chosen processes encompass waste collection and transportation, treatment, and disposal.

Two scenarios were developed, and the key distinction lies in the treatment of waste. In the first scenario, all biodegradable waste is collected and transported to a composting facility, where it undergoes separation into compost, emissions, and residues that are subsequently sent to landfills. In the second scenario, the analysis focuses on the process of anaerobic digestion for the same projected volume of biodegradable waste.

For this research, the spatial boundary is given by the administrative border of Republic of Serbia. For mass and substance balancing, a systems boundary for the time of one year has been chosen.

### RESULTS AND DISCUSSION

In Fig. 1, the composting process is applied to the total amount of biodegradable waste that is predicted for the Republic of Serbia in 2037, which is 1,235,251 tons. Anaerobic digestion technology was applied to the same amount of waste and the mass balance is shown in Fig. 2. With this paper, we want to show the differences in the results of technologies for the treatment of the same amount of biodegradable waste.

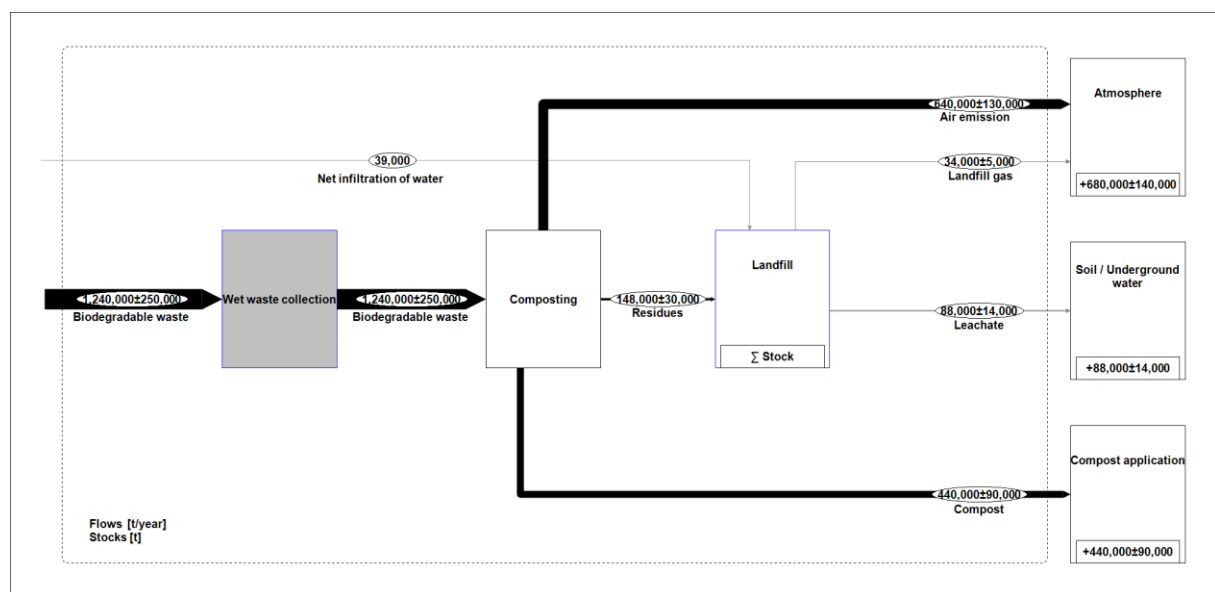
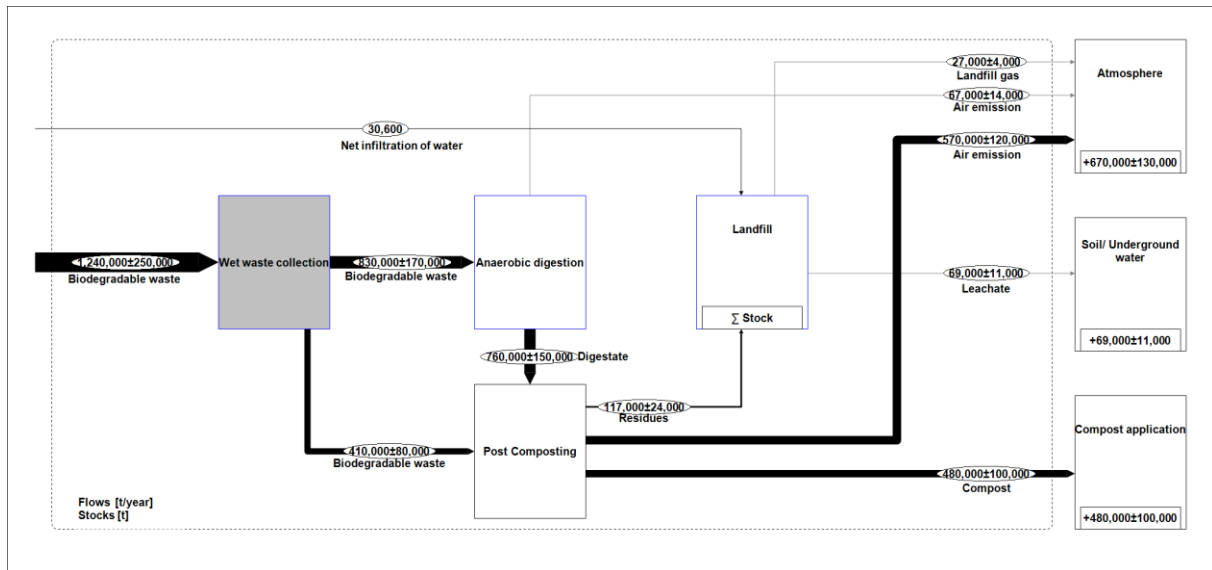


Fig. 1. Composting process (material flow analysis)



**Fig.2.** Anaerobic digestion process (material flow analysis)

A substance flow analysis for Cd and Pb was applied for these two scenarios. The atmosphere, hydrosphere and secondary product - compost do not represent the final sink, so in this case they are defined as intermediate sink of the substances. Therefore, the substances that the waste management systems will direct into these environmental media will, after a certain period of time, end up in other "final" sinks. The landfill in this case represents the final sink that emits substances over a longer period of time. Depending on the quality of the deposited material, we can classify landfills as more or less suitable final sinks for certain substances. The sanitary landfill represents a conditionally suitable final sink, while the landfill for residues after incineration would represent a suitable destination for Cd and Pb, but it was not taken into account in this case.

**Table 1.** Intermediate and final sinks

Substance	Intermediate sink			Final sink
	Atmosphere	Hydrosphere	Product-compost	Sanitary landfill
Cd	-	-	-	±
Pb	-	-	-	±

\*Legend:

- inappropriate sink

± conditionally appropriate sink

Table 2 and 3 present the data resulting from the substance flow analysis. The tables display the annual emissions of cadmium and lead, quantified in kilograms, directed towards both intermediate and final sinks.

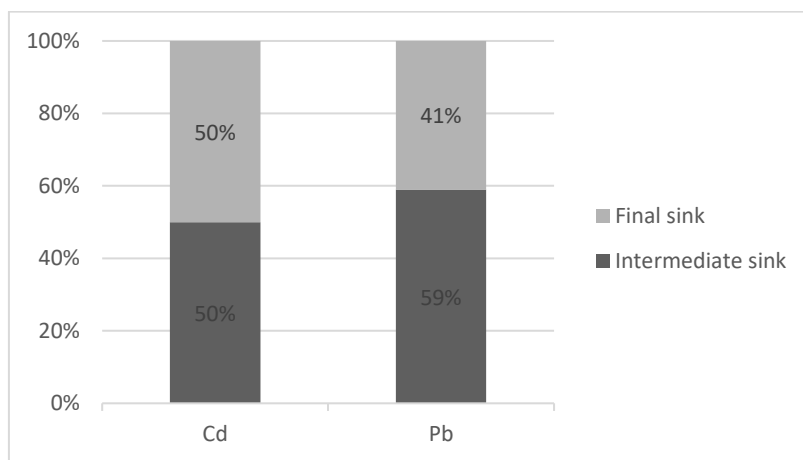
**Table 2.** Substances in composting process (kg/year)

Substance	Intermediate sink			Final sink
	Atmosphere	Hydrosphere	Product-compost	Sanitary landfill
Cd	0.008	0.123	648.505	648.377
Pb	0.781	0.762	10968.393	7620.592

**Table 3.** Substances in anaerobic digestion process (kg/year)

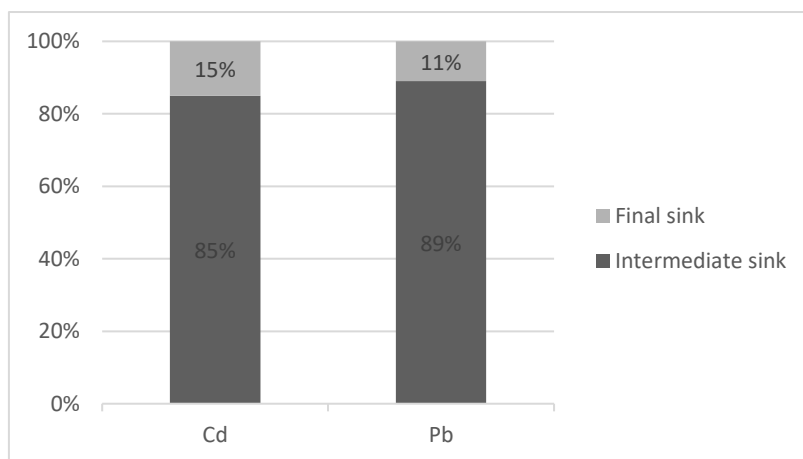
Substance	Intermediate sink			Final sink
	Atmosphere	Hydrosphere	Product-compost	Sanitary landfill
Cd	0.004	0.037	1102.461	194.512
Pb	0.055	0.389	16545.556	2044.529

Figures 3 and 4 illustrate the ratio between intermediate and final sinks for visualization purposes. Regarding the composting process, 50% of cadmium and 41% of lead end up in the final destination, with the remaining portion of these substances predominantly residing in the intermediate sink as compost material.



**Fig.3.** The distribution of substances between the final and intermediate sinks in composting process

Concerning the anaerobic digestion process, only 15% of cadmium and 11% of lead ultimately reach the final destination, while the majority of these substances primarily remain in the intermediate sink as compost material.



**Fig.4.** The distribution of substances between the final and intermediate sinks in anaerobic digestion process

## CONCLUSION

Waste management should adopt a comprehensive approach, considering both qualitative and quantitative aspects. While it is crucial to align with the waste management objectives set by the EU, it is essential not to focus solely on qualitative objectives. To achieve sustainable waste management, it is imperative to divert biodegradable waste from landfills. When devising future waste management systems, careful consideration should be given to how various technologies handle hazardous substances.

This paper presents the difference in results in the approach method of treating biodegradable waste. Notably, the results exhibit significant disparities, with cadmium (Cd) quantities of 648 kg/year for the composting process and 1102 kg/year for the anaerobic digestion process, as well as lead (Pb) quantities of 10968 kg/year for the composting process and 16546 kg/year for the anaerobic digestion process, respectively.

The evolution of future waste management systems should not be limited only to quantitative objectives, it should equally emphasize qualitative goals such as protection of human health and environment, resource conservation and sustainable waste management.

## REFERENCES

- [1] Waste management program of the Republic of Serbia for the period 2022-2031, Based on the Article 38 Paragraph 1 of the Law on the Planning System of the Republic of Serbia ("Official Gazette of the RS", number 30/18), 2018.
- [2] Stanisavljevic, N., Brunner, P. H., Megacities need both: Circular economy and final sinks! *Waste Management and Research*, No. 39(12), pp. 1437–1439, 2021.
- [3] IMG. (2014). IMG (International Management Group) – Analiza podataka o količini i sastavu komunalnog otpada u Republici Srbiji i njihova projekcija za period 2014. – 2030, 2014.
- [4] Waste management program in the Republic of Serbia for the period 2022-2031. ("Official Gazette of RS", No. 12/2022), 2022.
- [5] Stentiford, E., Bertoldi, M., *Solid Waste Technology & Management*. Volume 2. Blackwell Publishing Ltd, 2011.
- [6] Onder, N., Scenario assessment of solid waste management for Izmir based on the methodology of material flow analysis. *Institute of Water Quality and Resource Management*, 2013.
- [7] Stanisavljevic, N., Brunner, P. H., Combination of material flow analysis and substance flow analysis: A powerful approach for decision support in waste management. *Waste Management and Research*, No. 32(8), pp. 733–744, 2014.
- [8] Cencic, O., Rechberger, H., Material Flow Analysis with Software STAN. *Journal of Environmental Engineering and Management*, No.18(I), pp. 440–447, 2008.



## MACHINE LEARNING-BASED ANALYSIS OF NITROGEN REMOVAL IN A WASTEWATER TREATMENT PLANT

Ana Vukmirović<sup>1</sup>, Nikola Jovišić<sup>2</sup>, Slobodan Ilić<sup>3</sup>, Srđan Vukmirović<sup>2</sup>,  
Ivana Mihajlović<sup>1</sup>

<sup>1</sup>University of Novi Sad, Faculty of Technical Sciences, Department of Environmental Engineering and Occupational Safety and Health, Serbia

e-mail: [ivanamihajlovic@uns.ac.rs](mailto:ivanamihajlovic@uns.ac.rs)

<sup>2</sup>University of Novi Sad, Faculty of Technical Sciences, Department of computing and control engineering, Serbia

<sup>3</sup>Institute for Artificial Intelligence R&D, Novi Sad, Serbia

**Abstract:** This work represents the application of machine learning (ML) in the assessment of total nitrogen (TN) removal from a municipal wastewater treatment plant (WWTP) in Serbia. The evaluation of the relationships between the operational parameters and water quality indicators, including the Hydraulic Retention Time (HRT), pH, temperature (T), TN and total phosphorus (TP) in the influent wastewater, and the corresponding levels of TN in the WWTP effluent was performed by a correlation matrix. Four ML models were used: Linear Regression (LR), a Multi-Layer Perceptron (MLP), Convolutional Neural Networks with one-dimensional filters (Conv1D) and a Long Short-Term Memory (LSTM). These models were applied to assess the significance of input parameters and to capture any time-dependent trends in TN concentrations. While all the evaluated ML models evaluated yielded acceptable R-squared values, the LR model emerged as the most practical and efficient choice for time series forecasting within this specific WWTP. This outcome underscores its suitability for providing accurate predictions of TN in municipal WWTP with a biological treatment process.

**Key words:** nutrient, municipal, water pollution, removal.

### INTRODUCTION

Effective wastewater treatment in WWTP is of principal importance to safeguard aquatic ecosystems and public health on a global scale [1]. However, WWTP operations aren't often effective enough due to the unpredictable nature of influent characteristics. The development and application of efficient models for the prediction of wastewater treatment can offer valuable decision-making support for day-to-day operations and management.

In a research study of Wu and cooperates [1] a novel hybrid model was created by combining a process-based WWTP model known as GPS-X with a data-driven ML model, Random Forest (RF). The primary aim was to enhance the accuracy of long-term hourly predictions of ammonium-nitrogen (NH<sub>4</sub>-N) concentrations in WWTP effluent. The study's outcomes revealed that the GPS-X-RF hybrid model outperformed other models, achieving a coefficient of determination (R<sup>2</sup>) of 0.95 and a root mean square error (RMSE) of 0.23 mg/L. In comparison, the GPS-X model achieved an R<sup>2</sup> of 0.93 and an RMSE of 0.33 mg/L, while the RF model yielded an R<sup>2</sup> of 0.84 and an RMSE of 0.41 mg/L. This hybrid approach, combining process-based modeling with data-driven machine learning, demonstrated its effectiveness in improving the precision of predictions in WWTP operations, emphasizing its potential for enhancing wastewater treatment efficiency and decision support.

Wang and collaborates introduce several ML models aimed at enhancing the control of effluent quality in the WWTP [2]. This framework utilizes several ML models, including RF models, Deep Neural Network (DNN) models, Variable Importance Measure (VIM) analyses and Partial Dependence Plot (PDP) analyses. The study was conducted at the Umeå WWTP in Sweden, focusing on effluent parameters such as Total Suspended Solids (TSS) and phosphate (PO<sub>4</sub><sup>3-</sup>), as well as various operational variables. The results of this research reveal that among the studied factors, influent T utilizes the most substantial influence on both TSS and phosphate

levels. Additionally, the TSS concentration within the aeration basins was found to have a significant impact on phosphate levels. This underscores the utility of ML techniques in understanding and controlling effluent quality in WWTPs, with a particular emphasis on the critical role of temperature and TSS levels.

Li et al. [3] explored the application of deep learning methods in modeling and predicting the treatment of municipal wastewater through anaerobic membrane bioreactors. The study involves the analysis of six parameters related to experimental conditions and eight parameters related to wastewater treatment efficiency. Three deep learning frameworks are proposed, with the densely connected convolutional network (DenseNet) achieving remarkable results. It attains a prediction accuracy of 97.44 %, while maintaining a short computation time, underscoring the efficiency of utilizing deep learning for predicting anaerobic membrane bioreactor treatment outcomes. These two research papers [2, 3] demonstrate the growing importance of ML and deep learning models in optimizing wastewater treatment processes.

Zaghloul and Achari investigated the simulation of the complete biological removal of nutrients from wastewater using artificial intelligence (AI) techniques [4]. This research introduces an innovative ML model that combines various AI techniques, including artificial neural networks, adaptive neuro-fuzzy inference systems, and support vector regression. The model is designed to predict a comprehensive set of 15 process parameters, encompassing biomass properties, operational variables, and output characteristics. The authors emphasize that adaptive ML models play an essential role in minimizing process disruptions and cost savings by optimizing wastewater treatment operations. The average correlation coefficient of 69 % was obtained with a normalized RMSE of 0.06 %, and a symmetrical mean absolute error of 7.5 %. This research highlights the potency of AI and ML models in enhancing the precision and comprehensiveness of wastewater treatment process simulations, particularly in cases of biological nutrient removal.

El-Rawy and collaborators focused on assessing wastewater quality in WWTPs, aiming to streamline the sampling process, reduce costs, decision-making time, and energy consumption [5]. The study presents two methods for predicting the removal efficiency of various water quality parameters, including TSS, Chemical Oxygen Demand (COD), Biochemical Oxygen Demand (BOD<sub>5</sub>), ammonia, and sulfide. The first method employs a range of prediction models, including traditional feed-forward (TF), deep feed-forward backpropagation (DFB), and deep cascade-forward backpropagation (DCB) networks. The second model is based on using deep learning time series forecasting (DLTSF) with an LSTM network. These models are trained, validated, and tested using real data from the El-Berk WWTP. The study's results demonstrate the effectiveness of these models in accurately predicting the removal efficiency of water quality parameters in the WWTP.

The study by Yaquba and collaborators highlights the development and application of a neural network based on the LSTM model to predict the removal efficiency of NH<sub>4</sub>-N, TN, and TP in anaerobic-anoxic-oxic membrane bioreactor [6]. This predictive model holds significant potential for real-time monitoring and process control strategies within wastewater treatment systems. By utilizing input parameters that encompass wastewater characteristics and operating variables, the LSTM model provides precise predictions of nutrient removal efficiency. The LSTM model's success in predicting NH<sub>4</sub>-N removal efficiency, along with its satisfactory performance for TN and TP, underscores its role in addressing environmental challenges related to nutrient pollution and eutrophication in water bodies.

This study is focused on evaluating the relationships between operational parameters and water quality indicators, including HRT, pH, T, TN and TP in the influent wastewater, and corresponding levels of TN in the WWTP effluent. The research objective of this paper is to apply ML models, including LR, MLP, Conv1D and LSTM for the prediction of TN contents in the effluent of a municipal WWTP in Serbia.

## **MATERIAL AND METHODS**

A comprehensive dataset spanning six years from a municipal WWTP in Serbia was used for efficiency evaluation. This WWTP employs a biological treatment process with activated



sludge, making it imperative to investigate the removal of essential nutrients, such as TN. Within a wastewater treatment plant, HRT stands as an essential operational parameter, alongside other operational factors such as T and pH values.

The raw dataset underwent rigorous refinement to enhance data quality. Outliers, which were likely artifacts stemming from measurement inaccuracies were systematically removed. To address missing data points, linear interpolation was employed to provide estimates for the gaps. Additionally, standardization was applied to the input data, a critical step to bolster its statistical significance and interpretability.

ML models, including LR, MLP, Conv1D and LSTM were used for the evaluation of TN efficiency. MLP are basic neural network architectures, consisting of only fully connected layers. They are frequently employed in the context of simple time-series related AI systems. They offer flexibility in modeling the intricate relationships between various process parameters – both the time dependent and the ones that are not. However, the challenge with MLPs in this context is their inherent complexity and the difficulty in extracting actionable insights from their black-box nature, which might hinder their application in real-time decision support.

Conv1D finds relevance in wastewater treatment systems, especially when dealing with time series data that exhibit spatial or structured dependencies. By applying convolutional filters, Conv1D models can identify patterns and correlations in data, which is particularly useful when monitoring the flow of wastewater through different treatment units. However, Conv1D models may have limitations in capturing the long-term temporal dynamics of certain chemical or biological processes, as the convolution captures only the limited time span around a given moment in time.

LSTMs, a type of recurrent neural network, are well-suited for modeling time series data within wastewater treatment plants. They excel at capturing the sequential nature of the data and can handle the complex, dynamic, and often non-linear relationships within the treatment processes. LSTMs can predict the behavior of various treatment parameters over time, which is valuable for optimizing plant operations and ensuring compliance with environmental regulations.

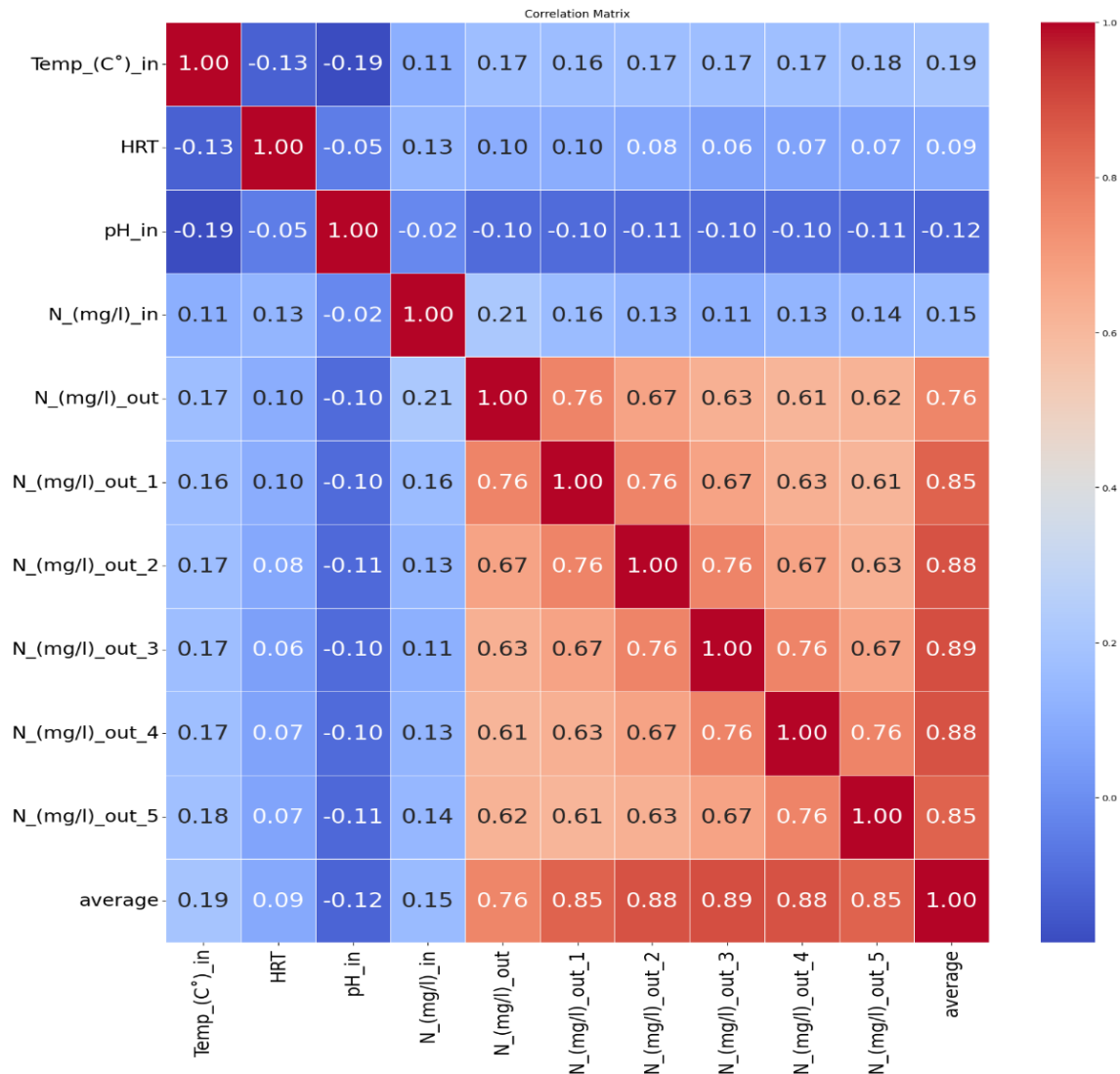
LR, a fundamental statistical modeling technique, can surprisingly outperform more complex neural networks in the context of wastewater treatment AI systems, which is observed in this study. The rationale behind this lies in the simplicity and the physical nature of the problem. In many instances, the relationships between certain process variables in a WWTP can be linear or exhibit a nearly linear trend. LR models align naturally with these linear dependencies and provide interpretable results, making them suitable for real-time monitoring and control. Wastewater treatment processes, while intricate, may not always require the complexity of neural networks. Linear regression, being a simple yet robust technique, can avoid overfitting and provide clear insights into relationships between key process variables. In cases where the data doesn't necessitate the complexity of neural networks, linear regression's simplicity is advantageous. Wastewater treatment processes are governed by physical and chemical principles, often resulting in linear relationships between key parameters. For example, the well-established laws of mass balance and reaction kinetics can often lead to linear dependencies. Linear regression, aligning naturally with these physical principles, can make more accurate predictions without introducing unnecessary complexity.

The experiments were written in Python. For the neural network part of them PyTorch framework was used with its predefined models and components that were customized to fit this problem. For the traditional ML modeling, we used to scikit-learn.

## RESULTS AND DISCUSSION

To ensure the reliability of the ML models, it was imperative to preprocess the data comprehensively. This preprocessing encompassed the handling of missing values, the identification and treatment of outliers, and the normalization of variables. These steps were essential to transform the raw data into a suitable format for training the ML models. The correlation matrix of the selected predictors for TN such as pH, T, HRT, TN in raw influent is

presented in Figure 1, where the number in the labels of TN indicates the number of days in past measurements.



**Fig. 1.** The correlation matrix of the selected predictors for TN

The correlation matrices between the input parameters (HRT, T, pH, TN, and TP in raw influent) and TN in effluent indicated that the most significant correlations were observed between TN and their respective values from previous days, as well as the average measurements over those preceding days. This phenomenon can be understood as a continuation of trends in the temporal concentrations of these parameters. Essentially, the influence of historical data exerts a more pronounced impact on the output parameters than the immediate measurements of relevant physical and chemical factors. This underscores the importance of temporal analysis over relying solely on isolated measurements, particularly in the context of effective wastewater management. Therefore, model selection and training were performed. The LR model, MLP and two more complex models (Conv1D, LSTM) were used to predict TN concentrations in the effluent of the WWTP. The resulting performance metrics for the proposed models (MLP, Conv1D, LSTM and Linear regression) for TN are shown in Table 1. The values of correlation coefficient  $R^2$ , RMSE and the mean absolute percentage error (MAPE) are displayed for all applied ML models.

**Table 1.** The performance metrics for the proposed ML models for TN prediction

Model	R <sup>2</sup>	RMSE	MAPE
MLP	0.702	7.501	0.261
Conv1D	0.704	7.483	0.265
LSTM	0.689	7.662	0.292
Linear regression	0.752	6.829	0.281

Among the models considered for TN prediction, the LR model demonstrated the highest predictive efficiency, achieving an R-squared value of 0.752. While the other used models, MLP, Conv1D and LSTM scored slightly lower R<sup>2</sup> values compared to the LR model, they still exhibited commendable accuracy with R<sup>2</sup> values exceeding 0.6 for both the training and testing sets. Notably, the LR model consistently displayed the lowest RMSE for TN prediction. MAPE values were similar for all applied ML models.

## CONCLUSION

The findings of this research underscore the effectiveness of employing a range of ML models for predicting the quality of effluent in terms of TN concentrations. This study makes a case for the importance of choosing the appropriate ML techniques, particularly in the context of time series forecasting, as demonstrated in the treatment plant in Serbia. While all the ML models evaluated in this study yielded acceptable R-squared values, it is worth noting that the LR model emerged as the most practical and efficient choice for time series forecasting within this specific WWTP. This outcome underscores its suitability for providing accurate predictions of TN in municipal WWTP. ML models have the potential to be invaluable tools for decision-makers within WWTP. They offer insights that can greatly facilitate enhanced plant management, cost reduction and performance optimization. By leveraging these models, decision-makers can make more informed choices about resource allocation and process adjustments, ultimately leading to more efficient operations. These models can simulate WWTP functions, forecast effluent quality and aid in the optimization of resource utilization. This dual role of improving prediction and enhancing operational efficiency positions ML as an asset in the ongoing examination to improve wastewater treatment processes.

## Acknowledgments

This work was supported by the Ministry of Education, Science and Technological Development through project no. 451-03-47/2023-01/200156: "Innovative scientific and artistic research from the FTS (activity) domain".

## REFERENCES

- [1] Wu, X., Zheng, Z., Wang, L., Li, X., Yang, X., He, J., Coupling process-based modeling with machine learning for long-term simulation of wastewater treatment plant operations, *Journal of Environmental Management*, Vol. 341, pp. 118116, 2023.
- [2] Wang, D., Thunéll, S., Lindberg, U., Jiang, L., Trygg, J., Tysklind, M., Souihi, N., A machine learning framework to improve effluent quality control in wastewater treatment plants, *Science of the Total Environment*, Vol. 784, pp. 147138, 2021.
- [3] Li, G., Ji, J., Ni, J., Wang, S., Guo, Y., Hu, Y., Liu, S., Huang, S. F., Li, Y. Y., Application of deep learning for predicting the treatment performance of real municipal wastewater based on one-year operation of two anaerobic membrane bioreactors, *Science of the Total Environment*, Vol. 813, pp. 151920, 2022.

- [4] Zaghoul, M. S., Achari, G., Application of machine learning techniques to model a full-scale wastewater treatment plant with biological nutrient removal, *Journal of Environmental Chemical Engineering*, Vol. 10, pp. 107430, 2022.
- [5] El-Rawy, M., Abd-Allah, M. K., Fathi, H., Ahmed, A. K. A., Forecasting effluent and performance of wastewater treatment plant using different machine learning techniques, *Journal of Water Process Engineering*, Vol. 44, pp. 102380, 2021.
- [6] Yaquba, M., Asifb, H., Kim, S., Lee, W., Modeling of a full-scale sewage treatment plant to predict the nutrient removal efficiency using a long short-term memory (LSTM) neural network, *Journal of Water Process Engineering*, Vol. 37, pp. 101388, 2020.



## THE IMPACT OF POLLUTANTS FROM THE MALJEVAC LANDFILL ON THE SURROUNDING LAND AND WATER OF THE PALESKI STREAM IN MONTENEGRO

**Nada Markovic<sup>1</sup>, Nebojsa Ralevic<sup>2</sup>, Miljan Šunjević<sup>2</sup>, Mirjana Vojinovic  
Miloradov<sup>2</sup>**

<sup>1</sup>Administration for Inspection Affairs, Sector for environmental protection, human safety and health, social and child protection, Podgorica, Montenegro

<sup>2</sup>University of Novi Sad, Technical Faculty, Novi Sad, Serbia

e-mail: [nadamarkovic71@t-com.me](mailto:nadamarkovic71@t-com.me)

**Abstract:** The application of positive waste management practices is an obligation of every industrial and human activity of modern society. The most important goals of waste management are the safety and health of people as well as the protection and improvement of the environment quality along with minimization of the waste production and disposal. The disposal of waste in landfills is currently the most common method of waste management in Montenegro. In the past period, due to inadequate waste disposal, contamination of all environmental media often occurred: water, land, air and biosystem, since industrial waste landfills represent a specific problem. During the process of joining the European Union and harmonizing domestic and European legislation, it is necessary to improve the waste management system and implement continuous monitoring of waste landfills. The paper includes rare and unique results of soil and surface water monitoring at locations around the Maljevac landfill in Montenegro. The goal of research is to initiate an opinion about the impact of landfills on land and surface water in Montenegro, which can lead to progress in remediation and removal of dangerous pollutants from the environment. The research indicate the contamination of the soil and surface water near the landfills body and the necessity of further investigations and the establishment of long-term, wide-ranging and comprehensive monitoring in all environmental media.

**Key words:** landfill, soil, underground water, surface water

### INTRODUCTION

In Montenegro, an increasing amount of industrial waste has been generated for years and disposed of in landfills without any prior treatment; this practice represents a huge waste of resources and a hazardous danger to the environment and human health. Inadequate disposal of industrial waste, which is created in technological processes, has a significant, negative impact on the environment and human health, especially the negative impact on air, underground and surface water, soil and the whole environment. Waste management is the implementation of prescribed measures for dealing with waste within the scope of collection, transport, storage, treatment and disposal, including the supervision of these activities and the care of waste management facilities after closure. Waste management is of great importance and is a complex process involving many technologies and disciplines. Proper waste management protects people's health, the quality of the environment and conserves natural resources.

Industrial waste dumps pose a great risk to human health and the environment. Depending on the type of waste that is disposed of, dangerous and toxic pollutants are identified in the environment, in the immediate vicinity of the landfill. Precipitation that is filtered and percolated through the mass of deposited waste dissolves harmful substances, which pollutes the soil and groundwater the most. The complex physicochemical and biochemical reaction and processes generate toxic and dangerous organic and inorganic substances and mixtures of unknown composition that are accumulated in the body of the landfill.

In the framework of previous research, in the body and surrounding environment of landfills, in addition to landfill gases methane (CH<sub>4</sub>), carbon dioxide (CO<sub>2</sub>), carbon monoxide (CO) and

hydrogen sulfide ( $\text{H}_2\text{S}$ ), toxic heavy metal cations can often be identified, as well as anionic species  $\text{NO}_2^-$ (aq),  $\text{NO}_3^-$ (aq),  $\text{PO}_4^{3-}$ (aq),  $\text{SO}_4^{2-}$ (aq) and other ions (anions and cations) [1]–[5]. During the second half of the twentieth century, water and land were often polluted by various substances that were used daily or were formed as byproducts in industrial production and combustion processes.

Developed countries confirmed that waste dumps are significant sources of pollutant emissions that affect the pollution of surface and underground water courses, air, soil and have a negative impact on human health.

Measurement of emissions and determination of the spread of pollutants from landfills are key elements of the research and scientific procedure in identifying the presence of pollutants and environmental conditions in the vicinity of landfills. The current monitoring and data collection system in Montenegro is not adequate, systematic and efficient and requires a research approach because it does not enable timely information on the presence and sources of pollutants in the environment. The quantification and proper assessment of environmental pollution caused by uncontrolled waste disposal is an important starting point for creating a sustainable monitoring program and improving the practice of managing industrial waste generated in the environment.

The landfill in Maljevac (fig. 1) is one of the five ecological hotspots of Montenegro, at this landfill for about 30 years waste, which forms slag and ash in the form of a water suspension from the Pljevlja Thermal Power Plant (fig. 2), has been disposed of. The landfill is located near Pljevlje, it extends in the valley of the Paleški potok, along the country road, surrounded by the settlements of Zbljevo, Komini, Ljuće and Zabrdje. The landfill for a long time characterize an ecological problem for the local population, above all the residents of the nearby village of Zbljevo, whose houses are located directly next to the landfill, and the activity of the landfill is also threatened by the underground and water of the Paleški Potok, which is located near the landfill.

During its construction, it was intended to be a temporary waste disposal site for the Pljevlja Thermal Power Plant, over time the landfill "went out of scope" it expanded to about 55 hectares and there was a problem with the stability of the earthen dam, since then it has been upgraded several times.



**Fig. 1.** Zbljevo and Maljevac landfill



The concentration levels of hazardous and harmful substances in agricultural land in Montenegro are regulated by the "Regulations on permitted quantities of dangerous and harmful substances in soil and methods for its testing" (Official Gazette of the Republic of Montenegro, 18/97). Bylaws prescribes the maximum permitted amounts of hazardous and harmful substances in the soil, which can lead to its pollution, and which are caused by the improper use of mineral fertilizers and plant protection products by legal and natural persons, as well as by the discharge of waste materials from various sources. The soil pollution is determined based on the standards prescribed by Bylaws, and for substances for which no standards are prescribed, by comparing soil samples with soil samples of the same type and a certain distance that are assumed not to be contaminated by disputed factors.

The Regulation on Classification and Categorization of Surface and Underground Water ("Official Gazette of Montenegro", No. 02/07) is in force in Montenegro. The general classification of water is done by dividing water into classes based on the permitted limit values of certain groups of parameters for specific purposes.



*Fig. 2. Pljevlja thermal power plant*

The dominant goal of the research activities was to collect data on the concentration levels of pollutants in environmental media (surface water and soil), at the Maljevac industrial waste landfill, and conduct an assessment of the risk to the health of the surrounding population [6], [7].

## **MATERIAL AND METHODS**

The experimental activities of the research included the use of the standardized and advanced laboratory equipment, with precisely defined methods for determining selected pollutants in the samples of surface water and soil. The determination of the pollutant concentrations level has been measured in the referenced laboratories. In October 2019, the Center for Ecotoxicological Research carried out activities related to the sampling and analysis of soil and surface water at the sites of the Maljevac landfill.

Equipment used for the analysis of organic contaminants:

- Gas chromatograph–mass spectrometer, GCMS QP 2010 plus, Shimadzu
- Gas chromatograph–mass spectrometer, GCMS QP 2020 plus, Shimadzu
- Gas chromatograph with ECD detector 2010 plus, Shimadzu



- Speed Extractor E-914, Buchi

Equipment used for the analysis of chemical elements:

- Atomic Absorption Spectrophotometer, AA6800, Shimadzu
- Inductively Coupled Plasma Optical Emission Spectrometry (ICP-OES), iCAP6300, Thermo
- Advanced Mercury Analyzer, AMA 254, Altec Ltd.
- Microwave Digestion, Speedwave Xpert, Berghof

Equipment for determining moisture content:

- Moisture balance, MA40, Sartorius

Preparation of soil samples:

- Ball Mills, RETSCH S100, Retsch
- Analytical Sieve Shaker, Analysen SIEB-AS 200, Retsch

Equipment for the analysis of cyanide, ammonia, anions

- Spectrophotometer, UV-1800, Shimadzu
- Equipment for pH determination
- pH/Ion meter, F24, Horiba
- Fluoride analysis equipment
- Ion meter, F24, Horiba with Fluoride electrode, Thermo Orion
- Equipment for determining electrical conductivity
- Conductometer, DS-15, HORIBA

## RESULTS AND DISCUSSION

Soil samples were taken from two locations 100 m from the edge of Cassette no. 2 from the north-west side and 100 m from the remediation zone, step 5, new precipitator-north-east side, the AF-ISM method was used.

*Table 1. Results of chemical soil analysis*

Examined parameter	Landfill Maljevac northwest side	Landfill Maljevac northeast side	Maximum allowed concentration	Method used
Fluorine (F)	1045 mg/kg	337mg/kg	300 mg/kg	AF-ISM

According to the results of the physical and chemical analysis, the soil sample was sampled at the location "Deponia Maljevac - Sample no. 1 (100 m from the perimeter of the Cassette on the north-western side), (table 1.) does not correspond to the conditions of the Bylaws on permitted amounts of hazardous and harmful substances in the soil and methods for its examination ("Official Gazette of the Republic of Croatia", no. 18/97) due to the increased content of fluorine, also according to the results of the physicochemical analysis of the soil sample 2, sampled at the location "Deponia Maljevac - (100 m from the remediation zone, step 5, new clarifier - north-east side)", does not meet the conditions of the Bylaws on permitted amounts of hazardous and harmful substances in soil and methods for its testing ("Official Gazette of the Republic of Croatia", No. 18/97) due to the increased concentration of fluorine. According to the aforementioned regulation, the Maximum allowed concentration of fluorine in the soil is 300 mg/kg, the results of the soil sample analysis 100 m from the perimeter of Cassette 2, taken from a depth of 30 cm, showed the presence of fluorine in a concentration of 1045 mg/kg, while the fluorine content in the sample 100 m from the zone remediation, step 5, new clarifier-north-east side was 337 mg/kg.

**Table 2.** Results of chemical analysis surface water before the Maljevac landfill

Examined parameter	Results of chemical analysis surface water before the Maljevac landfill	Maximum allowed concentration	Method used
Ratio Ca/Mg	7,4 mol	2-3 mol	SMEW3500CaD* SMEW.2340
Oxidizability	10,8 mg KmnO <sub>4</sub> /L	5 mg KmnO <sub>4</sub> /L	SMVP.134

According to the results of the physicochemical analysis of the surface water sample, Paleški potok before the Maljevac Landfill, (table 2), the water does not comply with the Regulation on the Classification and Categorization of Surface and Groundwater ("Official Gazette of Montenegro", no. 02/07) due to increased content of oxidizability and Ca/Mg ratio, according to the aforementioned Rulebook of Maximum allowed concentration, the Ca/Mg ratio is 2-3 moles, while in the tested sample the Ca/Mg ratio was 7.4 moles. In the same water sample, the oxidizability was 10.8 mg KMnO<sub>4</sub>/L, while the Maximum allowed concentration oxidizability was 5mg KMnO<sub>4</sub>/L. The SMEW350CaD\*SMEW.2340 method was used to determine the Ca/Mg ratio, while the oxidizability was determined according to the SMVP.134 method.

**Table 3.** Results of chemical analysis surface water after the Maljevac landfill

Examined parameter	Results of chemical analysis surface water after the Maljevac landfill	Maximum allowed concentration	Method used
Ratio Ca/Mg	11 mol	2-3 mol	EPA 200.7*
Oxidizability	12,9 mg KmnO <sub>4</sub> /L	5 mg KmnO <sub>4</sub> /L	SMVP.134
Electrical conductivity	1560 μ/S cm	300 μ/S cm	MEST EN 27888:2009*
Turbidity	21 NTU	1-10 NTU	SMVP.118*
Nitrites	0,166 mg/L	0,003 mg/L	SMEW4500NO2B*
Vanadium	0,19 mg/L	0,001 mg/L	MEST EN ISO 17294-2:2013*
Cyanides	0,12 MG/L	0,001 mg/L	SMEW 4500CN-E*
Arsenic	0,090 mg/L	0,001 mg/L	MEST EN ISO 17294-2:2013*
Ammonium ion	2,1 mg/L	0,00-0,02	SMVP.179*

The results of the physicochemical analysis of the surface water sample indicate, Paleški potok after the Maljevac Landfill (Table 3), the water does not comply with the Regulation on Classification and Categorization of Surface and Groundwater ("Official Gazette of Montenegro", no. 02/07) due to increased content turbidity, electrical conductivity, pH value, Ca/Mg ratio, nitrite, vanadium, arsenic, cyanide, oxidizability and ammonium ions.

According to the SMVP.118\* method, turbidity was 21 NTU, while the allowed concentration is 1-10 NTU, electrical conductivity, according to the MEST EN 27888:2009\* method, was 1560 μS/cm, the allowed concentration is 300-1000 μS/cm. pH value, according to the MEST EN ISO 10523:2013\* method, was 11.4, and the permitted pH is in the range of 6.8-8.3, the Ca/Mg ratio, according to the EPA2007\* method, was 11 moles, while the permitted concentration is 2-3 higher. Nitrites, according to the SMEW4500NO2B\* method, were 0.166 mg/L, the permissible concentration is 0.003-0.02. Also, the concentration of Vanadium, according to the MEST EN ISO 17294-2:2013\* method, was 0.19, while 0.001-0.100 is allowed, Arsenic, according to the MEST EN ISO 17294-2:2013\* method, the concentration was 0.090 mg/L, while is allowed from 0.001-0.05mg/L. The cyanide concentration, according to the

SMEW4500CN-E\* method, was 0.12, the permissible cyanide concentration is 0.001 - 0.005mg/L, the oxidizability, according to the SMVP.134 method, was 12.9 mg KMNO<sub>4</sub>/L, the permissible oxidizability is 5-8 KMNO<sub>4</sub> /L, the concentration of ammonium cations, according to the SMVP.179\* method, was 2.1 mg/L, while the allowed concentration is from 0.00 to 1 mg/L.

The Bylaws on specific characteristics of the location, construction conditions, sanitary and technical conditions, the manner of operation and closure of the landfill ("Official Gazette of the Republic of Montenegro", No. 31/13) defines the conditions of groundwater quality and measurement of their quality.

## CONCLUSION

Results indicate that observed and sampled landfill has a negative impact on its whole surrounding environment, and that it is necessary to perform frequent and controlled monitoring of both soil and surface water, as well as fragile groundwater. The high probability that pollutants from the soil and surface water will also end up in the very subtle system of groundwater, requires additional attention.

Sustainable development implies long-term very dynamic balancing of ecological, economic and social impacts at the level of society, with the necessity to achieve sustainable development as well as to meet the needs of future generations. Waste management system optimization and modernization is the precursor and the obligation of every society as the optimal platform for secure and resilient vision and strategy development of the Montenegro.

## REFERENCES

- [1] B. Obrovski, I. Mihajlovic, M. Vojinovic-Miloradov, M. Sremacki, I. Spanik, and M. Petrovic, "Groundwater quality assessment of protected aquatic eco-systems in cross-border areas of Serbia and Croatia," *J. Serbian Chem. Soc.*, vol. 87, no. 1, pp. 121–131, 2022.
- [2] P. Kjeldsen and M. Christophersen, "Composition of leachate from old landfills in Denmark," *Waste Manag. Res. J. a Sustain. Circ. Econ.*, vol. 19, no. 3, pp. 249–256, 2001.
- [3] F. Parvin and S. M. Tareq, "Impact of landfill leachate contamination on surface and groundwater of Bangladesh: a systematic review and possible public health risks assessment," *Appl. Water Sci.*, vol. 11, no. 6, p. 100, Jun. 2021.
- [4] S. S. Kale, A. K. Kadam, S. Kumar, and N. J. Pawar, "Evaluating pollution potential of leachate from landfill site, from the Pune metropolitan city and its impact on shallow basaltic aquifers," *Environ. Monit. Assess.*, vol. 162, no. 1–4, pp. 327–346, Mar. 2010.
- [5] R. H. Hredoy, M. A. B. Siddique, M. A. Akbor, M. A. A. Shaikh, and M. M. Rahman, "Impacts of Landfill Leachate on the Surrounding Environment: A Case Study on Amin Bazar Landfill, Dhaka (Bangladesh)," *Soil Syst.*, vol. 6, no. 4, p. 90, Nov. 2022.
- [6] N. Stanisavljević, D. Ubavin, B. Batinić, J. Fellner, and G. Vujić, "Methane emissions from landfills in Serbia and potential mitigation strategies: a case study," *Waste Manag. Res. J. a Sustain. Circ. Econ.*, vol. 30, no. 10, pp. 1095–1103, Oct. 2012.
- [7] R. Weber *et al.*, "Dioxin- and POP-contaminated sites—contemporary and future relevance and challenges," *Environ. Sci. Pollut. Res.*, vol. 15, no. 5, pp. 363–393, Jul. 2008.



**XIII International Conference Industrial  
Engineering and Environmental  
Protection 2023 (IIZS 2023)  
October 05-06, 2023, Zrenjanin, Serbia**

---

# **Session 8**

## **Students Session**



## APPLYING MULTICRITERIA ANALYSIS IN SOLAR PANEL SELECTION: INSIGHTS FROM VIKOR METHOD

Luka Djordjević<sup>1\*</sup>, Borivoj Novaković<sup>1</sup>, Mića Djurdjev<sup>1</sup>, Sanja Stanisavljev<sup>1</sup>,  
Milan Nikolić<sup>1</sup>

<sup>1</sup>University of Novi Sad, Technical Faculty "Mihajlo Pupin", Zrenjanin, Serbia  
e-mail: [luka.va134@gmail.com](mailto:luka.va134@gmail.com)

**Abstract:** Solar panels have become an integral part of the global energy infrastructure in a rapidly progressing transformation toward sustainable energy. Advances in solar energy technology, along with increased economic feasibility, have contributed to a growing acceptance of solar panels as an efficient and sustainable energy source. This paper thoroughly addresses the analysis and comparison of the performance of different solar panels using sophisticated multi-criteria analysis methods. The authors applied the VIKOR method in this study to tackle the challenge of multi-dimensional decision-making. The results obtained by the VIKOR method offer valuable insight into how different criteria relate to each other and how these relationships affect the final ranking of the panels. This analysis shows that the best solar panel is not necessarily the one with the highest power or efficiency, nor the most expensive one. On the contrary, the panel that offers the best balance of all criteria, including less obvious ones such as surface and weight, may be the best choice. This paper thus provides a practical framework for evaluating solar panels and demonstrates how multi-criteria analysis can assist decision-making in complex, multi-dimensional situations.

**Keywords:** VIKOR method, multicriteria analysis, solar panel, renewable energy

### INTRODUCTION

Solar panels have become an exceedingly popular renewable energy source in a world increasingly focused on reducing carbon footprint and combating climate change [1,2]. Thanks to continual technology development, the efficiency of solar panels is constantly increasing, while simultaneously, a reduction in manufacturing costs contributes to their ever-growing economic accessibility. All this makes solar panels an attractive solution for households, businesses, and governmental agencies worldwide [3,4].

Despite these positive trends, choosing the appropriate solar panel is not a straightforward task. It is not reduced to merely comparing prices or maximum panel power. Instead, making the right choice involves considering many criteria - from economic ones, such as price and warranty, to technical ones, such as power, efficiency, surface, and panel weight. Moreover, choosing the optimal solar panel often involves a trade-off between these criteria, as a panel that excels in one category may not be the best in another.

This paper employs a multi-criteria analysis method to assist in making informed decisions in this complex context. Multi-criteria analysis is an advanced decision-making technique that systematically compares different alternatives based on multiple criteria [5,6]. This method is already recognized in many sectors, including engineering, economics, politics, and ecology, for its ability to encompass various aspects of a problem and make decisions that best meet the set goals [7,8].

In this paper, multi-criteria analysis is applied to the selection of solar panels. The analysis focuses on seven different models of solar panels, each with its specific performances and characteristics. Applying the VIKOR method allows for these panels to be precisely ranked. It determines which of them best meets the set criteria, thus offering concrete and useful guidelines for consumers, planners, and decision-makers in the renewable energy sector.

## MULTI-CRITERIA ANALYSIS

Multi-criteria analysis plays a key role in many sectors, including engineering, finance, healthcare, and ecology, where complex decisions often have to be made considering multiple factors.

The multi-criteria analysis approach provides a flexible and reliable methodology allowing decision-makers to compare alternatives and make informed decisions efficiently [9]. It enables the integration of quantitative and qualitative criteria into a unified decision-making model, taking into account interactions among the criteria [10].

Among the numerous multi-criteria analysis methods, some of the most recognized are [11,12]:

- AHP - Analytic Hierarchy Process,
- TOPSIS - Technique for Order of Preference by Similarity to Ideal Solution,
- ELECTRE - Elimination and Choice Expressing Reality, and
- VIKOR - Vlsekriterijumska Optimizacija i Kompromisno Rešenje.

### VIKOR Method

The VIKOR method is a sophisticated multi-criteria analysis method developed to solve decision-making problems with conflicting and opposing criteria [13,14]. Its core principle is ranking alternatives and identifying a compromise solution that is closest to the ideal solution. The VIKOR method approaches the decision-making problem from a compromise perspective, recognizing that the optimal solution is not always available. Instead, the goal is to identify a solution that best balances all criteria, providing the "least distance" from the ideal solution [15].

In the context of our research, we used the VIKOR method to rank seven different solar panels. Each panel was evaluated based on six criteria: price, power, efficiency, warranty, surface area, and weight. After that, using the formulas of the VIKOR method, each panel was given a final rank, providing clear ranked alternatives.

The VIKOR method is used for ranking alternatives based on multiple criteria. The VIKOR method process can be divided into several basic steps:

### Data Normalization

The first step is the normalization of criterion values. This is necessary so that each criterion can be adequately compared with others. This step is usually performed using "linear normalization," which transforms all values to a range between 0 and 1.

The equation for normalization is [16–18]:

$$v_{ij} = (x_{ij} - \min(x_{ij})) / (\max(x_{ij}) - \min(x_{ij})) \quad (1)$$

where  $x_{ij}$  is the original value of the  $i$ -th criterion of the  $j$ -th alternative, and  $v_{ij}$  is the normalized value.

### Determining the Criterion Weights

Criterion weights ( $w_j$ ) represent the importance of each criterion in decision-making. Weights can be equal for all criteria or different, depending on the specific preferences of the decision maker.

### Calculation of S and R Values

The next step is to calculate the S (average distance) and R (maximum distance) values for each alternative. These values are calculated based on the equations [13,16,17]:

$$S_i = \sum_{j=1}^n w (v_j - v_{ij}) / (v_j - v_j^-) \quad (2)$$

$$R_i = \max [w_j (v_j - v_{ij}) / (v_j - v_j^-)] \quad (3)$$

where  $v_{ij}$  is the normalized value of the  $j$ -th criterion for the  $i$ -th alternative,  $w_j$  is the weight of the  $j$ -th criterion,  $v_{j0}$  is the worst value of the  $j$ -th criterion, and  $v_j^-$  is the best value of the  $j$ -th criterion.

### Calculation of Q Values

After calculating the S and R values, the Q value for each alternative is calculated. The Q value represents a compromise solution between S and R values.

The equation for calculating Q values is [13,16,17]:

$$Q_i = v \cdot (S_i - S^*) / (S^- - S^*) + (1 - v) \cdot (R_i - R^*) / (R^- - R^*) \quad (4)$$

where  $v$  is the discrimination measure coefficient (usually taken as  $v=0.5$ ),  $S^*$  and  $R^*$  are the minimal S and R values, and  $S^-$  and  $R^-$  are the maximum S and R values.

### Ranking of Alternatives

Finally, alternatives are ranked according to the Q value. The alternative with the smallest Q value is ranked the highest.

The VIKOR method provides a compromise solution, which means that the highest-ranked alternative may not stand out in all criteria, but it will provide the best balance among all criteria.

In this study, we used seven of the most efficient solar panels available in 2023 for our analysis. Below, we provide a table detailing the basic information about these solar panels. This table serves as a vital resource for understanding the fundamental characteristics of each panel, including its price, power, efficiency, warranty, surface area, and weight. This data forms the basis of our multicriteria analysis using the VIKOR method.

**Table 1.** Basic information and characteristics of the solar panels

Panel	Make	Model	Power	Efficiency	Warranty	Area	Weight
A	Aiko Solar	Black Hole series	460 W	23.6 %	15 y	1.917m <sup>2</sup>	20.5 kg
B	Recom Tech	Black Tiger	460 W	23.6 %	15 y	2.164 m <sup>2</sup>	27 kg
C	Longi Solar	Hi-Mo 6 Scientist	450W	23.0 %	15 y	2.009 m <sup>2</sup>	20.8 kg
D	SunPower	Maxeon 6	440 W	22.8 %	15 y	1.932 m <sup>2</sup>	21.8 kg
E	Canadian Solar	Hi Hero HJT	445 W	22.8 %	15 y	1.953 m <sup>2</sup>	23 kg
F	Jinko Solar	Tiger NEO N-Type	440 W	22.5 %	20 y	1.998 m <sup>2</sup>	22 kg



<b>G</b>	REC	Alpha Pure R	430 W	22.3 %	20 y	1.934 m <sup>2</sup>	21.5 kg
----------	-----	--------------	-------	--------	------	----------------------	---------

For our weights, we have assumed the following: 0.3 for cost, 0.3 for power, 0.2 for efficiency, 0.1 for warranty, 0.05 for area, and 0.05 for weight. The weights are arbitrary and reflect priorities. The sum of all weights equals 1.

## RESULTS AND DISCUSSION

*Table 2. Table of normalized values*

	Price	Power	Efficiency	Warranty	Surface	Weight
A	0.696	1.000	1.000	0.750	0.887	0.930
B	0.681	1.000	1.000	0.750	1.000	1.000
C	0.720	0.978	0.975	0.750	0.929	0.966
D	0.704	0.957	0.966	0.750	0.893	0.807
E	1.000	0.967	0.966	0.750	0.903	0.849
F	0.813	0.957	0.954	1.000	0.923	0.814
G	0.687	0.283	0.945	1.000	0.894	0.794

*Table 3. Table of weighted values*

	Price	Power	Efficiency	Warranty	Surface	Weight
A	0.209	0.300	0.200	0.075	0.089	0.047
B	0.204	0.300	0.200	0.075	0.100	0.050
C	0.216	0.293	0.195	0.075	0.093	0.048
D	0.211	0.287	0.193	0.075	0.089	0.040
E	0.300	0.290	0.193	0.075	0.090	0.042
F	0.244	0.287	0.191	0.100	0.092	0.041
G	0.206	0.085	0.189	0.100	0.089	0.040

*Table 4. Table of "S" and "R" values, and VIKOR index*

	S	R	VIKOR
A	0.920	0.300	0.610
B	0.929	0.300	0.615
C	0.920	0.293	0.607
D	0.895	0.287	0.591
E	0.990	0.300	0.645
F	0.955	0.287	0.621
G	0.709	0.206	0.458

Based on this information, we can rank the panels according to the VIKOR index from smallest to largest (best to worst):

- G,
- D,
- C,
- A,
- B,
- F,
- E.

The results of the multi-criteria analysis, using the VIKOR method, provide an interesting perspective on selecting solar panels. Our study included ranking seven different solar panels considering six criteria: price, power, efficiency, warranty, area, and panel weight.

A conventional assumption might be that the most expensive solar panel, with the highest power and efficiency, is automatically the best choice. However, our analysis paints a different picture. Indeed, the best solar panel differs from the one with the highest price or the one with the highest power or efficiency. Instead, the highest-ranked solar panel is the one that provides the most optimal balance among all considered criteria.

Interestingly, while price, power, and efficiency are often the main criteria when choosing solar panels, our analysis points to the significance of other factors, such as warranty, area, and weight of the panel. These criteria can often be overlooked, but our study shows that they can significantly impact the overall score and ranking of solar panels.

Specifically, the weight and area of the panels have shown a negative impact on the ranking. In other words, a smaller area and weight are desirable as they influence the ease of installation and spatial efficiency of the system. As a result, panels with lower weight and area are rated higher, all other things being equal.

It is also important to note that while the VIKOR method has provided an efficient way of ranking solar panels, it does not give an absolute rating. In other words, the choice of the best solar panel will always depend on the specific needs and preferences of the user. The VIKOR method provides an objective and systematic framework for comparing different alternatives based on multiple criteria, which can assist in informed decision-making.

## **CONCLUSION**

The application of the VIKOR method in evaluating and choosing solar panels, as presented in this paper, clearly demonstrates its effectiveness as a decision-support tool in complex situations where multiple criteria need to be considered. Our study has used six criteria to assess and rank seven different solar panels, thus offering a practical and systematic methodology for identifying the most suitable model.

Given the growing popularity and necessity of renewable energy, our research results can benefit both consumers and experts in the renewable energy industry. With these results, potential users of solar panels can make an informed decision about the model that best suits their specific needs and preferences.

However, it is important to note that while the VIKOR method provides an objective and systematic framework for evaluating and ranking solar panels based on defined criteria, the final decision should always consider the user's specific context and needs.

In addition, future research could expand the scope of this work by including additional criteria in the analysis. For example, criteria such as panel durability, the environmental impact of solar panel production, and their recyclability could be important factors to consider. Also, future work could explore other multi-criteria analysis methods, such as AHP (Analytic Hierarchy Process) or TOPSIS (Technique for Order of Preference by Similarity to Ideal Solution), to validate the robustness and reliability of our results.

In conclusion, our work emphasizes the importance and applicability of multi-criteria analysis methods in the renewable energy sector. This paper will stimulate further research and applications of multi-criteria analysis in this important field.

## **ACKNOWLEDGMENTS**

The research is conducted through the project »Creating laboratory conditions for research, development, and education in the field of the use of solar resources in the Internet of Things«, at the Technical Faculty »Mihajlo Pupin« Zrenjanin, financed by the Provincial Secretariat for Higher Education and Scientific Research, Republic of Serbia, Autonomous Province of Vojvodina, Project number 142-451-3118/2022-01.

## REFERENCES

- [1] Sovacool BK, Griffiths S, Kim J, Bazilian M. Climate change and industrial F-gases: A critical and systematic review of developments, sociotechnical systems and policy options for reducing synthetic greenhouse gas emissions. *Renewable and Sustainable Energy Reviews*; 141:110759, 2021. <https://doi.org/10.1016/j.rser.2021.110759>.
- [2] Nematchoua MK, Sadeghi M, Reiter S. Strategies and scenarios to reduce energy consumption and CO2 emission in the urban, rural and sustainable neighbourhoods. *Sustainable Cities and Society*; 72:103053, 2021. <https://doi.org/10.1016/j.scs.2021.103053>.
- [3] Falchetta G, Michoud B, Hafner M, Rother M. Harnessing finance for a new era of decentralised electricity access: A review of private investment patterns and emerging business models. *Energy Research & Social Science*; 90:102587, 2022. <https://doi.org/10.1016/j.erss.2022.102587>.
- [4] Van Opstal W, Smeets A. Circular economy strategies as enablers for solar PV adoption in organizational market segments. *Sustainable Production and Consumption*; 35:40–54, 2023. <https://doi.org/10.1016/j.spc.2022.10.019>.
- [5] Wu JJW, Mazzuchi TA, Sarkani S. Comparison of multi-criteria decision-making methods for online controlled experiments in a launch decision-making framework. *Information and Software Technology*; 155:107115, 2023. <https://doi.org/10.1016/j.infsof.2022.107115>.
- [6] Gao R, Wang L, Zhang L, Zhang C, Jun K-W, Kim SK, et al. A multi-criteria sustainability assessment and decision-making framework for DME synthesis via CO2 hydrogenation. *Energy*; 275:127467, 2023. <https://doi.org/10.1016/j.energy.2023.127467>.
- [7] Raos S, Hranic J, Rajšl I, Bar K. An extended methodology for multi-criteria decision-making process focused on enhanced geothermal systems. *Energy Conversion and Management*; 258:115253, 2022. <https://doi.org/10.1016/j.enconman.2022.115253>.
- [8] Lotfian Delouyi F, Ranjbari M, Shams Esfandabadi Z. A Hybrid Multi-Criteria Decision Analysis to Explore Barriers to the Circular Economy Implementation in the Food Supply Chain. *Sustainability*; 15:9506, 2023. <https://doi.org/10.3390/su15129506>.
- [9] Kokaraki N, Hopfe CJ, Robinson E, Nikolaidou E. Testing the reliability of deterministic multi-criteria decision-making methods using building performance simulation. *Renewable and Sustainable Energy Reviews*; 112:991–1007, 2019. <https://doi.org/10.1016/j.rser.2019.06.018>.
- [10] Yannis G, Kopsacheili A, Dragomanovits A, Petraki V. State-of-the-art review on multi-criteria decision-making in the transport sector. *Journal of Traffic and Transportation Engineering*; 7:413–31, 2020. <https://doi.org/10.1016/j.jtte.2020.05.005>.
- [11] Sałabun W, Wątróbski J, Shekhovtsov A. Are MCDA Methods Benchmarkable? A Comparative Study of TOPSIS, VIKOR, COPRAS, and PROMETHEE II Methods. *Symmetry*; 12:1549, 2020. <https://doi.org/10.3390/sym12091549>.
- [12] Solangi YA, Shah SAA, Zameer H, Ikram M, Saracoglu BO. Assessing the solar PV power project site selection in Pakistan: based on AHP-fuzzy VIKOR approach. *Environ Sci Pollut Res*; 26:30286–302, 2019. <https://doi.org/10.1007/s11356-019-06172-0>.
- [13] Nikolić M, Radovanović L, Desnica E, Pekez J. THE APPLICATION OF VIKOR METHOD FOR SELECTION OF MAINTENANCE STRATEGIES. *TEHNIČKA DIJAGNOSTIKA*; 4:25–32, 2010. UDC: 620.17:621.791.1/982.540.
- [14] Zakeri S, Chatterjee P, Cheikhrouhou N, Konstantas D. Ranking based on optimal points and win-loss-draw multi-criteria decision-making with application to supplier evaluation problem. *Expert Systems with Applications*; 191:116258, 2022. <https://doi.org/10.1016/j.eswa.2021.116258>.
- [15] Taherdoost H, Madanchian M. An Effective Compromising Ranking Technique for Decision Making. *Macro Manag & Public Polic*; 5:27–33, 2023. <https://doi.org/10.30564/mmpp.v5i2.5578>.

- [16] Greco S, Ehrgott M, Figueira JR, editors. Multiple Criteria Decision Analysis: State of the Art Surveys. vol. 233. New York, NY: Springer New York; 2016. <https://doi.org/10.1007/978-1-4939-3094-4>.
- [17] Opricovic S, Tzeng G-H. Compromise solution by MCDM methods: A comparative analysis of VIKOR and TOPSIS. *European Journal of Operational Research*; 156:445–55, 2004. [https://doi.org/10.1016/S0377-2217\(03\)00020-1](https://doi.org/10.1016/S0377-2217(03)00020-1).
- [18] Pérez-Velázquez A, Oro-Carralero LL, Moya-Rodríguez JL. Supplier Selection for Photovoltaic Module Installation Utilizing Fuzzy Inference and the VIKOR Method: A Green Approach. *Sustainability*; 12:2242, 2020. <https://doi.org/10.3390/su12062242>.



## GREEN MARKETING CONCEPT AS A SIGN OF SUSTAINABLE BUSINESS

Verica Gluvakov<sup>1</sup>, Dragan Čockalo<sup>1</sup>, Mihalj Bakator<sup>1</sup>, Mila Kavalić<sup>2</sup>, Stefan Ugrinov<sup>1</sup>

<sup>1</sup>University of Novi Sad, Technical Faculty "Mihajlo Pupin", Zrenjanin, Serbia

<sup>2</sup>Faculty of Technical Sciences, Novi Sad, Serbia

e-mail: [verica.gluvakov@tfzr.rs](mailto:verica.gluvakov@tfzr.rs), [dragan.cockalo@tfzr.rs](mailto:dragan.cockalo@tfzr.rs), [mihalj.bakator@tfzr.rs](mailto:mihalj.bakator@tfzr.rs),  
[mila.kavalic@tfzr.rs](mailto:mila.kavalic@tfzr.rs)

**Abstract:** Marketing represents one of the key business concepts and a significant management activity, and sustainable business becomes key to achieving a competitive advantage consisting of effective processes, productivity improvement, cost reduction and corporate social responsibility. In modern business conditions, to ensure the future of the company, it is necessary to implement the principles of sustainable development in all forms of activity in order to prove that products, services and processes can contribute to the creation of a sustainable environment. From these principles, new marketing strategies and concepts have been developed, among which is the concept of green marketing, which implies the implementation of an ecological approach in the activities of the organization, from research and development to production and distribution. This paper presents a literature review in order to make universal conclusions and highlights the importance of green marketing in sustainable business.

**Key words:** green marketing, sustainability, business

### INTRODUCTION

Green marketing is a phenomenon that has gained significant importance on the modern market. The concept of green marketing originates from the 1990s, and gained importance in the early 2000s, after which it began to be applied in various industries. Today, many companies globally are successfully implementing green marketing practices. Green marketing is the process of developing products and services and promoting them to satisfy customers who prefer products of high quality, performance and convenience at an affordable price, which at the same time have no harmful impact on the environment. It includes a wide range of activities such as product modification, production process changes, modified advertising and packaging changes in order to reduce the harmful impact of products and their consumption and disposal on the environment. Companies around the world strive to reduce the impact of products and services on the climate and other environmental parameters. According to the American Marketing Association, green marketing is the marketing of products that are assumed to be environmentally safe [1]. This concept refers to a holistic marketing concept in which the production, consumption and disposal of products and services occur in a way that is less harmful to the environment with a growing awareness of the implications of global warming, non-biodegradable solid waste and the harmful impact of pollutants. While „going green“ may seem expensive for companies in the short term, it proves to be a cost-effective solution in the long term. Companies that apply the concept of green marketing have increased the rate of targeting consumers who are concerned about the environment and, through that concern, such consumers are interested in integrating environmental issues into their purchasing decisions. Therefore, the traditional marketing mix (4P) has been modified into a green marketing mix consisting of green products, prices, promotion and distribution.

The green marketing mix is significantly and positively related to the perception of brand quality, and its characteristics are [2]:

- Green product – environmental and social performance in production, use and disposal is significantly improved compared to conventional products. Production strategies for green products are recycling, reuse, reduction of packaging, durability, repairability and transport safety. These products are characterized by eco-labels that can improve sales and product image, as well as make consumers more aware of environmental issues and help protect the environment. The use of eco-labels increases consumer knowledge which is an important factor in environmental conscious behavior.
- Green price – green pricing represents the pricing of green products that compensates consumers' price sensitivity against their willingness to pay more for the product's environmental performance. Green price combined with green promotion has a positive effect on consumer satisfaction, which affects consumer loyalty.
- Green place – refers to management tactics related to distribution, production to consumption and reverse logistics that lead to cost and time savings, increased revenue, reduced inventory costs, better inventory management and better customer service.
- Green promotion – implies environmental advertising and marking on consumer purchases. Successful green strategy depends on effective communication and companies should provide complete, accurate and understandable information about their products. Green advertising should emphasize the environmental benefits of products, promote sustainable lifestyles, enhance the green brand image and reduce the information asymmetry typical of green products.

Effective green marketing requires the application of good marketing principles to make green products desirable to consumers. Managers, in addition to products, should identify green systems and processes. The business of organizations of the future will be based on sustainability. Rising prices, pollution and resource consumption drive innovation towards healthier and more efficient high-performance products and sustainable services depend on authentically communicating and delivering the consumer's desired value to the market [3]. It is equally important to monitor the changes that occur in individuals, which are related to the emergence of the segment of green consumers. Creating a database and monitoring the behavior of green consumers are the basis for further and faster development of the green marketing strategy at all levels of society.

Corporate sustainability is defined as a business approach focused on creating long-term value for the company, through consideration of all dimensions of the relationship to its economic, social and natural environment. Creating an ecological, „green strategy“ focused on the environment and including all aspects of environmental responsibility is considered as an very important step towards sustainable development [4]. Considering the goals of sustainable development, companies develop innovative business models that bring a competitive advantage to improve the sustainability performance of organizations. The process of building a sustainable business model is an innovative part of the business strategy. Such a model can meet the economic, environmental and social goals of the organization, and the popularity and success rate of sustainable business models have increased in all application domains along with the increasing use of advanced technologies [5].

A sustainable economic system is increasingly desirable and for its realization it is necessary to innovate business models by adopting sustainable solutions. As the level of productivity of a country determines the sustainable level of prosperity that an economy can reach and maintain over a longer period of time, the development of the competitiveness of the market economy implies the improvement of general factors of competitiveness in accordance with the principles of sustainable development. In modern organizations, it is important to develop the ability of quick and successful transition to new business models, which represent an important source of competitive advantage and improvement of the company's sustainable performance. Therefore, sustainable development as a long-term process is important for survival, and it is considered the only concept of balanced development in the future [6].

## **MATERIAL AND METHODS**

### **The subject and the problem of research**

This paper will deal with the analysis of the concept of green marketing in sustainable business, by considering different literature sources and studies. Also, this paper will try to indicate the importance of green marketing as a sign of sustainability.

### **Research goal**

The main goal of this paper is to present the role and importance of green marketing concept in sustainable business, as well as to examine the aspects of that role.

### **Research question**

Based on analyzed theories, we will try to answer the following question:

- What is the role of green marketing in sustainable business development?

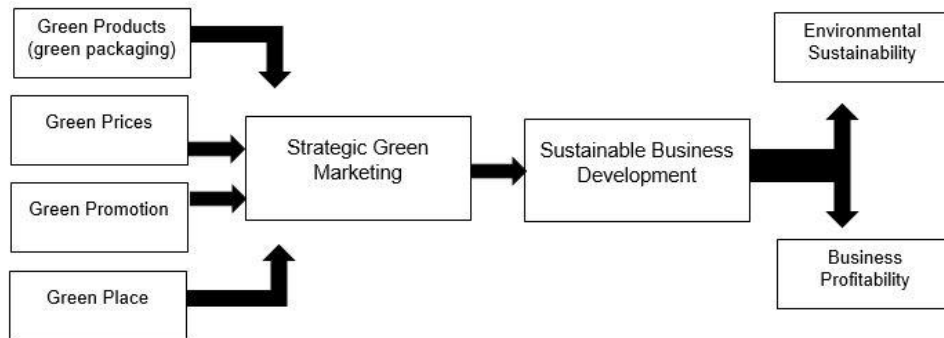
### **Research method**

This is a form of theoretical research in which universal conclusions are made by considering previous conducted research, studies and literature. Research will consider results of as many other authors as possible in order to make conclusions.

## **RESULTS AND DISCUSSION**

Green marketing strategies contribute to sustainable business by developing products that meet consumer needs without harming the environment and maintain a commitment to sustainable development. Companies should adopt a proactive approach in green marketing to gain a competitive advantage by positioning products in the mind of customers. In order for business to be sustainable, it is necessary to include suppliers, distributors and business partners. One of the main reasons for focusing on green marketing is the development of sustainable business, promoting environmentally friendly packaging, sustainable business practices and marketing campaigns that can create environmental awareness among consumers. Green marketing provides various advantages in sustainable business development, and a company promoting green marketing needs to make several adjustments in its internal functioning, such as restructuring its business processes. Important benefits of green production are cost reduction, waste reduction, reduction of raw material usage and energy saving costs, resulting in increased business profits. Green marketing has created an opportunity for companies to increase their market share by introducing environmentally friendly products. For business to be sustainable, green marketing strategy must focus on green brand positioning, appropriate market segmentation, green pricing, green supply chain, reduced waste, green promotion strategy, green marketing mix and green supplier partnership [7]. The concept of green marketing is very broad, offering business incentives and growth opportunities, and although modifying business and production processes may involve initial costs, it will save money in the long term. Companies that develop new and improved products and services with environmental impacts in mind give themselves access to new markets, significantly increase profits and achieve competitive advantages over those who do not represent environmentally responsible alternatives [8]. The benefits of green marketing for sustainable business are shown in Figure 1 [7].





*Fig. 1. Framework of sustainable business development*

Another benefit in the field of green marketing is the tendency of companies to maintain their competitive position. In many cases, companies observe competitors promoting their environmental behavior and try to imitate it. In some cases, such competitive pressure has led the entire industry to modify itself and thereby reduce its harmful behavior towards the environment. Many companies are beginning to realize that they are members of the wider community and must behave in an environmentally responsible manner. This results in environmental issues being integrated into the company's corporate culture. Therefore, companies that can reduce harmful waste can achieve significant savings. Due to the minimization of waste, companies are often forced to rethink their production processes. In those cases, they often develop more efficient production processes that not only reduce waste, but also reduce the need for some raw materials. This serves as a double saving for the company. In other cases, companies try to find different solutions instead of minimizing waste. In those cases, they try to find markets or uses for their waste materials, where one company's waste becomes an input to another company's production [8].

In a business environment where consumers determine the destiny of a company, green marketing provides a proactive strategy for companies to serve the market by placing environmentally friendly products and services that reduce or minimize any harmful impact on the environment. The primary responsibility of managers is to innovate and adopt new marketing strategies that would protect the global ecosystem as well as satisfy customers. In addition to the above, significant reasons for adopting green marketing include future opportunities and competitive advantage, corporate social responsibilities (CSR), government pressure, increased customer consciousness and deterioration of climatic conditions [9].

Sustainable development requires sustainable marketing, that is, marketing efforts that are not only competitively sustainable, but also environmentally sustainable. The critical role of marketing in sustainable development involves meeting the needs of the present without compromising the ability of future generations to meet their own needs. In response to the challenge of simultaneously advancing economic development and environmental protection as sustainable development requires, companies have developed and adopted green marketing strategies and other corporate strategies. Among the key strategies are, in addition to the mentioned marketing mix, changing consumers from a culture of consumption to environmentally concerned consumers, adopting an eco-marketing orientation as a business philosophy, government intervention, inventory life cycle analysis and partnering for success. Green marketing focuses on undertaking all marketing activities while protecting the environment. On the other hand, sustainable development requires that future generations inherit the natural environment in the same or better condition as the previous generations inherited it. This requires the protection and improvement of the environment. Therefore, it can be said that sustainable development is a dependent variable of green marketing and other factors. The application of green marketing solves challenges with positive outcomes of improved organizational performance and a better physical environment that will lead to sustainable development [10].

An increasing number of public and private sector companies are concerned about the environment and believe that green marketing is relevant to sustainable development. Also, it

is perceived as a promotional tool for building customer trust. The results of certain study [11] showed that companies should embrace environmental protection as a market opportunity, not just as a compliance with increasing environmental pressures and laws. Green marketing should become the norm in developing countries, not the exception because it has the potential to significantly contribute to saving the environment and society from pollution and contribute to sustainable development. Green marketing should not be considered just another approach to marketing, but should be implemented much more strongly, because it has an ecological and social dimension. With the threat of global warming, it is extremely important that green marketing becomes the norm, not the exception. Recycling of paper, metal, plastic and similar materials, as well as production raw materials in a safe and ecologically harmless way should become systematized and universal.

## **GUIDELINES AND RECOMMENDATIONS**

Implementation of the concept of green marketing as a sign of sustainable business requires careful planning and a strategic approach. Based on the research and analysis presented in this paper, the following guidelines and recommendations are offered for organizations seeking to successfully integrate sustainability into their marketing strategies:

- Companies should develop a clear sustainable identity which should be authentic and consistently communicated in order to build trust with consumers.
- Companies should be transparent about their sustainable practices, products and results.
- Companies should play an active role in educating consumers about sustainable choices and the benefits of such choices.
- Companies should regularly assess the impact of their marketing campaigns on consumers and society and adjust their approach accordingly.
- Companies should consider collaborating with relevant sustainable initiatives, non-governmental organizations and other partners to enhance their sustainable impact and expand their reach.
- Companies should stay informed about the latest trends and practices and be ready to adapt their strategies according to changes in the social and environmental environment.

In sum, companies can successfully use the concept of green marketing as a tool for promoting sustainable business and achieving long-term benefits for both your business and society as a whole.

## **CONCLUSION**

Based on the analyzed literature, it can be concluded that green marketing has a key role in promoting sustainable development in business. Through informing, shaping awareness and creating demand for sustainable products and services, green marketing enables organizations not only to achieve business success, but also to contribute to environmental preservation and social progress, key aspects of sustainable development (RQ:1). Green marketing not only informs consumers about the environmental and social benefits of products, but also encourages their decisions that favor sustainability. Through carefully applied marketing strategy, organizations can raise awareness of the importance of sustainable practices, educate consumers about their opportunities to contribute to environmental conservation, and motivate them to support sustainable products and services. Green marketing as an integral part of business strategy is becoming an increasingly important factor in achieving sustainable business development.

## REFERENCES

- [1] Mishra, P., Sharma, P.: Green marketing: Challenges and opportunities for business, *BVIMR Management Edge*, 7(1), 2014.
- [2] Dangelico, R.M., Vocalelli, D.: "Green Marketing": An analysis of definitions, strategy steps, and tools through a systematic review of the literature, *Journal of Cleaner production*, 165, pp. 1263-1279, 2017.
- [3] Ghoshal, M.: Green Marketing-A changing concept in changing time, *BVIMR Management Edge*, 4(1), pp. 82-92, 2011.
- [4] Ivanović, V., Krstić, B.: Dimenzije održivog razvoja i društvene odgovornosti preduzeća u konceptu balansne karte performansi, *Society of Economist „Ekonomika“*, pp. 85-107, 2017.
- [5] Nosratabadi, S., Mosavi, A., Shamshirband, S., Zavadskas, E. K., Rakotonirainy, A., Chau, K. W.: Sustainable business models: A review, *Sustainability*, 11(6), pp. 1663, 2019.
- [6] Geissdoerfer, M., Vladimirova, D., Evans, S.: Sustainable business model innovation: A review, *Journal of cleaner production*, 198, pp. 401-416, 2018.
- [7] Rathore, B.: Impact of Green Marketing on Sustainable Business Development, Cardiff Metropolitan University, Presentation, 2022.
- [8] Sarkar, A.: Green marketing and sustainable development challenges and opportunities, *International Journal of Marketing, Financial Services & Management Research*, 1(9), pp. 120-134, 2012.
- [9] Das, S. M., Dash, B. M., Padhy, P. C.: Green marketing strategies for sustainable business growth, *Journal of Business Management & Social Sciences Research*, 1(1), pp. 82-87, 2012.
- [10] Kinoti, M. W.: Green marketing intervention strategies and sustainable development: A conceptual paper, *International journal of business and social science*, 2(23), pp. 263-273, 2011.
- [11] Garg, A.: Green marketing for sustainable development: an industry perspective, *Sustainable Development*, 23(5), pp. 301-316, 2015.



## ROLE OF GREEN HUMAN RESOURCE MANAGEMENT IN SMALL AND MEDIUM ENTERPRISES IN CREATING SUSTAINABLE BUSINESS CONCEPT

**Stefan Ugrinov<sup>1</sup>, Dragan Čočkalo<sup>1</sup>, Mihalj Bakator<sup>1</sup>, Mila Kavalić<sup>2</sup>, Verica Gluvakov<sup>1</sup>**

<sup>1</sup>University of Novi Sad, Technical Faculty "Mihajlo Pupin", Zrenjanin, Serbia

<sup>2</sup>University of Novi Sad, Faculty of Technical Sciences, Novi Sad, Serbia

e-mail: [verica.gluvakov@tfzr.rs](mailto:verica.gluvakov@tfzr.rs), [dragan.cockalo@tfzr.rs](mailto:dragan.cockalo@tfzr.rs), [mihalj.bakator@tfzr.rs](mailto:mihalj.bakator@tfzr.rs),  
[mila.kavalic@tfzr.rs](mailto:mila.kavalic@tfzr.rs), [stefan.ugrinov@tfzr.rs](mailto:stefan.ugrinov@tfzr.rs)

**Abstract:** This paper conducts a comprehensive literature review to examine the role of Green Human Resource Management (GHRM) in Small and Medium Enterprises (SMEs) concerning the development of sustainable business concepts. GHRM encompasses various strategies, including recruitment, training, employee engagement, and sustainability communication, all of which are critical in enhancing environmental performance and fostering a culture of sustainability within SMEs. Through an extensive analysis of existing literature, this review highlights key insights and trends in the field of GHRM in SMEs. It explores how GHRM practices have been conceptualized and applied in different contexts and their impact on the creation of sustainable business concepts. The findings from this literature review underscore the significance of GHRM in aligning SMEs with sustainability goals, providing a synthesis of existing knowledge and identifying gaps for future research. This review is a valuable resource for practitioners, policymakers, and scholars interested in understanding the theoretical and practical dimensions of GHRM in the context of SMEs and sustainability.

**Keywords:** Green Human Resource Management, Sustainability, Small and Medium-sized Enterprises, Eco-consciousness, Employee engagement, Environmental impact

### INTRODUCTION

Organizations are currently shifting their strategies and goals to be more environmentally conscious as the significant literature focused on larger firms rather than SMEs despite SMEs highly impacting the environment due to their commercial activities [1]. As engines of innovation, employment, and economic growth, SMEs wield considerable influence in shaping societal and environmental outcomes. In response to the imperatives of sustainability, the convergence of SMEs with Green Human Resource Management (GHRM) presents an essential avenue for aligning organizational practices with ecological responsibility. Accordingly, the top management of SMEs reconsiders their objectives and broadens the scope of their operations by including green HRM practices to improve environmental performance [2]. Organizations and employees both benefit from the adoption of GHRM practices because it boosts employee morale and productivity [3]. As the world confronts pressing challenges like climate change and resource depletion, SMEs embracing GHRM hold the potential to lead by example. By fostering employee engagement, optimizing resource utilization, and positioning themselves as eco-conscious entities, SMEs can not only mitigate their environmental footprint but also elevate their competitive standing in an increasingly sustainability-conscious market.

Amidst this shift towards environmental consciousness, it is imperative to recognize that the landscape of business is rapidly evolving. Consumers are increasingly making choices based on a company's commitment to sustainability, and investors are factoring in environmental, social, and governance (ESG) criteria when making decisions. SMEs that adopt GHRM practices align themselves with these evolving market dynamics, not only appealing to a growing eco-conscious customer base but also attracting socially responsible investors. The benefits of such alignment extend beyond mere financial gains; it enhances the overall

reputation and brand image of SMEs, positioning them as responsible corporate citizens in the eyes of the public and stakeholders.

Furthermore, the adoption of GHRM practices within SMEs has a ripple effect throughout their supply chains and networks. These SMEs often collaborate with other small businesses, suppliers, and service providers, amplifying the impact of sustainable practices. As they demand eco-friendly inputs and services, they contribute to the broader adoption of sustainability principles across industries. Thus, exploring the interconnectedness of SMEs in driving sustainability through GHRM is not only insightful but also critical in understanding the broader implications of these practices in today's globalized business environment.

## **MATERIAL AND METHODS**

### **The subject and the problem of research**

This paper will deal with the analysis of the role of green human resource management in small and medium enterprises in creating sustainable business concepts, by considering different literature sources and studies. Also, this paper will try to indicate the importance green human resource management practices in creating green work climate and green employee behavior.

### **Research goal**

Primary goal of this paper is to showcase role of green human resource management practices in creating sustainable business concept.

### **Research question**

Based on analyzed theories, we will try to answer the following question: How does green human resource management practices in SMEs create sustainable business concept?

### **Research method**

This is a form of theoretical research in which universal conclusions are made by considering previous conducted research, studies and literature. Research will consider results of as many other authors as possible in order to make conclusions

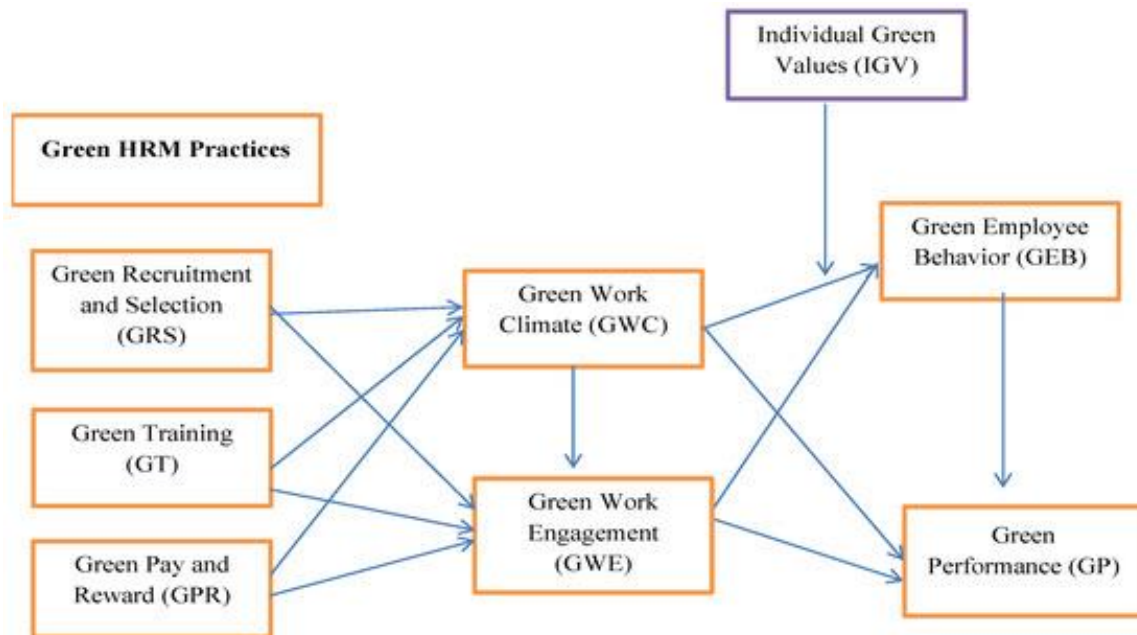
## **RESULTS AND DISCUSSION**

GHRM involves practices such as green recruitment and selection (GRS), green training (GT), and green pay and reward (GPR) to increase green employee performance [4]. GHRM in the organizational setting can improve green performance (GP) by recruiting environmentally concerned employees, providing green training, encouraging employees to be involved in green activities by establishing green reward structures, and creating a platform where employees can engage in green initiatives. Aim of green training as a process is to help employees better understand environmental awareness, sustainable practices, green technologies, corporate social responsibility and sustainable.

Circular economy also plays big role in GHRM. Its core concept is based on reducing waste and maximizing resource efficiency. In addition, a green work climate (GWC) is essential for increasing green work engagement (GWE) and performance [5]. GWC, GWE, and green employee behavior (GEB) are among the significant constructs in enhancing GP [6].

The relationship between GHRM practices, GWC, GWE, GEB, and GP has been built on the basis of abilities, motivation, and opportunities (AMO) theory [7]. According to AMO theory, HRM is carried out by increasing employee ability by motivating employees to become high-performers and boosting employee performance by providing them with a platform through which they can avail opportunities and become more productive. Based on the grounds of AMO theory, the objective of green performance can be achieved if employees are provided

with GHRM practices such as GT, are recruited on the basis of green values, and are rewarded conditionally by carrying out an effective performance management system [8].



*Fig. 1. Connection and influence of GHRM practices*

Improving environmental performance requires maximizing the incorporation of training, teamwork, monetary and non-monetary rewards, and sustainable goals [9]. It encompasses the collective efforts, values, and norms within an organization that prioritize environmental responsibility and contribute to a greener and more sustainable workplace. Creating a green work climate requires a holistic approach that involves leadership commitment, employee engagement, and ongoing efforts to integrate sustainability into various aspects of the organization's operations and culture.

GHRM involves the policies and practices that motivate employees to participate in activities that promote socially responsible green behavior to create an environmentally conscious and resource-efficient organization [10]. In line with this, several studies have found a positive relationship between GRS and GWC. GRS has been recognized as a key constituent of GHRM practices. Some authors outlined GRS in three parts: employees' green awareness, green employer branding, and green criteria to attract candidates [11]. Firstly, the most crucial part of GRS is employees' green awareness, and it includes personality qualities such as green conscientiousness awareness and agreeableness that allow sustainable goals to be met [12]. Employees who value a green environment have been discovered to have an active improvement in their environmental knowledge, hence providing a GWC [13]. GEB involves both in-role and extra-role green behavior [14]. Green employee behavior can manifest in various ways, such as reducing energy consumption, minimizing waste generation, using eco-friendly products, promoting recycling, and participating in conservation programs. These are the kinds of activities that would be expected of an employee and, as a result, are part of a person's formal work responsibilities [15]. According to HRM behavioral research, a green organizational climate influences employee work attitudes and behavior [16]. Employee outcomes of green behavior are highly dependent on a green work climate, according to HRM behavioral research [17].

Promoting green employee behavior requires a supportive organizational culture, leadership commitment, and ongoing efforts to make environmentally friendly practices convenient and accessible for employees. Encouraging green behavior not only benefits the environment but also fosters employee engagement, collaboration, and a sense of purpose in contributing to a better world.

Work engagement, for example, has been found to improve employees' GP by helping them better understand GHRM principles and giving them the power to apply positive environmental solutions [18]. Employees propagate proactive environmental measures when they are incorporated into their day-to-day roles [19]. As a result, creating an engaging atmosphere has a positive impact on employee performance, allowing employees to focus on improvement projects such as eliminating inefficient tasks [20]. Therefore, minimizing and reusing raw materials improves recycling, reduces resource consumption, lowers prices, and improves overall GP [21]. Employees are encouraged to actively engage in eco-friendly initiatives, such as participating in tree planting drives, waste reduction campaigns, and energy-saving challenges. Green employee behavior involves a shift in everyday practices, such as using reusable water bottles, reducing paper usage by opting for digital documents, and turning off lights and electronic devices when not in use.

## **GUIDELINES AND RECOMMENDATIONS**

Based on literature review done in this paper we can conclude that green human resource management in small and medium enterprises plays a significant role in creating sustainable business model. Following results of research we can give following recommendations to small and medium enterprises who are considering introducing GHRM practices in their companies:

- Small and medium enterprises should consider introducing GHRM practices because that is one of the best way to achieve sustainable business model.
- During recruitment process companies should focus on green recruitment and selection because that's one the best ways to be sure that new employees goals align with goals of their company.
- Green training and green pay are essential in constantly improving employee performance and motivation, therefore improving performance of company too.
- SMEs should focus on implementing GHRM practices because result of that is green work climate and green work engagement. Both of these play huge role in achieving sustainable business concept.

As we can reasons for implementing GHRM practices in SMEs are twofold. First is achieving sustainable and successful business concept and second is preserving the environment.

## **CONCLUSION**

As SMEs embrace green HRM, they navigate a transformative journey that converges human potential and environmental consciousness. The evolving landscape underscores the importance of leadership commitment, employee engagement, and the seamless integration of green initiatives across HR functions. By fostering an environment of continuous learning, innovation, and collaboration, SMEs can harness the collective power of their workforce to drive tangible sustainability outcomes. In the years to come, the success of SMEs will be indelibly intertwined with their ability to champion green human resource management. The trajectory of sustainable development hinges upon their capacity to integrate eco-centric values into organizational DNA, inspire green employee behavior, and pioneer resilient practices that endure beyond profitability. As SMEs embark on this odyssey, they wield the potential to not only enhance their competitive edge but also contribute to a healthier, more harmonious planet for generations to come.



## REFERENCES

- [1] Song, W.; Yu, H.; Xu, H. Effects of green human resource management and managerial environmental concern on green innovation. *Eur. J. Innov. Manag.*, 24, 951–967, 2020.
- [2] Shafaei, A.; Nejati, M.; Yusoff, Y.M. Green human resource management. *Int. J. Manpow.*, 41, 1041–1060, 2020.
- [3] Roscoe, S.; Subramanian, N.; Jabbour, C.J.; Chong, T. Green human resource management and the enablers of green organizational culture: Enhancing a firm's environmental performance for sustainable development. *Bus. Strategy Environ.*, 28, 737–749, 2019.
- [4] Pham, N.T.; Tučková, Z.; Jabbour, C.J.C. Greening the hospitality industry: How do green human resource management practices influence organizational citizenship behavior in hotels? A mixed-methods study. *Tour. Manag.*, 72, 386–399, 2019.
- [5] Graves, L.M.; Sarkis, J.; Gold, N. Employee pro-environmental behavior in Russia: The roles of top management commitment, managerial leadership, and employee motives. *Resour. Conserv. Recycl.*, 140, 54–64, 2019.
- [6] Chen, S.; Jiang, W.; Li, X.; Gao, H. Effect of Employees' Perceived Green HRM on Their Workplace Green Behaviors in Oil and Mining Industries: Based on Cognitive-Affective System Theory. *Int. J. Environ. Res. Public Health*, 18, 4056, 2021.
- [7] Renwick, D.W.; Redman, T.; Maguire, S. Green human resource management: A review and research agenda. *Int. J. Manag. Rev.*, 15, 1–14, 2013.
- [8] Iftikar, T.; Hussain, S.; Malik, M.I.; Hyder, S.; Kaleem, M.; Saqib, A. Green human resource management and pro-environmental behavior nexus with the lens of AMO theory. *Cogent Bus. Manag.*, 9, 2124603, 2022.
- [9] Pham, N.T.; Thanh, T.V.; Tučková, Z.; Thuy, V.T.N. The role of green human resource management in driving hotel's environmental performance: Interaction and mediation analysis. *Int. J. Hosp. Manag.* 2020, 88, 102392
- [10] Pham, N.T.; Tučková, Z.; Jabbour, C.J.C. Greening the hospitality industry: How do green human resource management practices influence organizational citizenship behavior in hotels? A mixed-methods study. *Tour. Manag.*, 72, 386–399, 2019.
- [11] Muisyo, P.K.; Qin, S. Enhancing the FIRM'S green performance through green HRM: The moderating role of green innovation culture. *J. Clean. Prod.*, 289, 125720, 2021.
- [12] Yong, J.Y.; Yusliza, M.Y.; Ramayah, T.; Fawehinmi, O. Nexus between green intellectual capital and green human resource management. *J. Clean. Prod.* 2019, 215, 364–374.
- [13] Islam, T.; Khan, M.M.; Ahmed, I.; Mahmood, K. Promoting in-role and extra-role green behavior through ethical leadership: Mediating role of green HRM and moderating role of individual green values. *Int. J. Manpow.*, 42, 1102–1123, 2020.
- [14] Dumont, J.; Shen, J.; Deng, X. Effects of green HRM practices on employee workplace green behavior: The role of psychological green climate and employee green values. *Hum. Resour. Manag.*, 56, 613–627, 2017.
- [15] Chen, S.; Jiang, W.; Li, X.; Gao, H. Effect of Employees' Perceived Green HRM on Their Workplace Green Behaviors in Oil and Mining Industries: Based on Cognitive-Affective System Theory. *Int. J. Environ. Res. Public Health*, 18, 4056, 2021.
- [16] Bhutto, T.A.; Farooq, R.; Talwar, S.; Awan, U.; Dhir, A. Green inclusive leadership and green creativity in the tourism and hospitality sector: Serial mediation of green psychological climate and work engagement. *J. Sustain. Tour.*, 29, 1716–1737, 2021.
- [17] Shoaib, M.; Abbas, Z.; Yousaf, M.; Zámečník, R.; Ahmed, J.; Saqib, S. The role of GHRM practices towards organizational commitment: A mediation analysis of green human capital. *Cogent Bus. Manag.*, 8, 1870798, 2021.
- [18] Ari, E.; Karatepe, O.M.; Rezapouraghdam, H.; Avci, T. A Conceptual Model for Green Human Resource Management: Indicators, Differential Pathways, and Multiple Pro-Environmental Outcomes. *Sustainability*, 12, 7089, 2020.

- [19] Tian, Q.; Robertson, J.L. How and When Does Perceived CSR Affect Employees' Engagement in Voluntary Pro-environmental Behavior? *J. Bus. Ethics*, 155, 399–412, 2017.
- [20] Su, X.; Xu, A.; Lin, W.; Chen, Y.; Liu, S.; Xu, W. Environmental leadership, green innovation practices, environmental knowledge learning, and firm performance. *Sage Open* 2020, 10, 2158244020922909
- [21] Ren, S.; Tang, G.; Jackson, S.E. Effects of Green HRM and CEO ethical leadership on organizations' environmental performance. *Int. J. Manpower*. 42, 961-983, 2020.



## GREEN MANAGEMENT AND GREEN ORGANIZATIONAL CULTURE IN MODERN BUSINESS

Dragana Kovač<sup>1</sup>, Edit Terek Stojanović<sup>1</sup>, Maja Gaborov<sup>1</sup>, Igor Vecštejn<sup>1</sup>

<sup>1</sup>University of Novi Sad, Technical Faculty "Mihajlo Pupin", Zrenjanin, Serbia

e-mail: [milosavljevd@yahoo.com](mailto:milosavljevd@yahoo.com)

**Abstract:** The problem we are facing is the increasing pollution of the environment. Issues of environmental protection are becoming increasingly important for organizations in modern business. On the one hand, there are laws and standards that require the minimization of environmental damage, and on the other hand, there are customers, who are increasingly aware of environmentally friendly products and requirements for such products. Therefore, care for the environment has a significant impact on the competitiveness of companies. In order for the company to turn to environmental protection, it is necessary to manage it in that way and to form an organizational culture that will be oriented towards environmental protection. This paper will describe green management, green organizational culture, as well as their impact on the competitiveness of companies.

**Key words:** green management, green organizational culture, green innovation, green performance

### INTRODUCTION

Environmental protection issues are becoming increasingly important for companies, as decision makers are faced with stricter environmental regulations and standards and with increased public sensitivity [1, 2]. Growing awareness and concern for environmental sustainability encourages organizations to integrate sustainability into their corporate strategies and activities. Organizations face increasing pressure to be environmentally friendly from stakeholders (consumers, investors, banks, NGOs, etc.) in order to reduce negative environmental impacts [3]. In order to respond to these demands, ensure survival and increase their competitiveness, organizations are forced to identify and implement innovative and sustainable solutions within their business [4].

One of the innovations in response to these demands is green management. Green management represents a proactive strategy for reducing negative environmental impacts, while increasing economic efficiency [5]. Green management is an initiative that aims to continuously improve the basics of environmental management, such as the development of personnel responsibility for environmental activities, environmental management systems and environmental communication, as well as the preservation of biodiversity [6]. Green management practices can be applied in any industry, from manufacturing to retail, hospitality to transportation. Organizations adopting green management practices can realize a number of benefits, including cost reduction, improved brand reputation, increased customer loyalty, improved employee morale [7].

One of the variables that has an impact on green innovation is green organizational culture. Green organizational culture is a system of values, beliefs, ideas, attitudes, which has the ultimate goal of promoting economic and ecological development [4]. A strong green organizational culture helps employees understand the organization's environmental strategy. Through activities and policies, organizations generate values of environmental protection, thus achieving a competitive advantage [8]. Organizations with a well-designed organizational culture can actively improve their green innovations, which not only affect the minimization of production waste and environmental pollution, but also strengthen the image and reputation of the organization, increase productivity and achieve competitive advantage [9, 10]. The adoption of green practices throughout the organization results in the transformation of the organizational culture into a green organizational culture. Designing a green organizational culture is a very important matter that requires the attention of senior

management. It is necessary to encourage employees to accept a green organizational culture and to behave in accordance with it, such as: turning off the lights in rooms that are not in use, using reusable packaging, coming to work by collective transport, which leads to raising environmental awareness and improving the image organizations in the public.

## GREEN MANAGEMENT

Green management has emerged as an important managerial topic for organizations, in order to achieve profit and market share on the one hand and commit to environmental protection on the other [11]. Green management is an approach to organizational management that seeks to reduce the impact of business operations on the environment, while simultaneously improving business efficiency and profitability. The focus of green management is on sustainability, and it includes making decisions and taking actions that are environmentally responsible, socially beneficial and economically sustainable [7]. Green management can also be recognized as a real tool for handling the complex properties of the business environment and for defining its development goals. One of the directions of building economic development is the greening of the economy through the support of investments in order to protect the environment and create green jobs in this area. The goal of green management is to support environmental protection [12].

In order to successfully apply green management practices, it is necessary to apply the following implementation steps [7, 13]:

- assessment of the current impact on the environment - analysis of energy consumption, water, waste generation and other factors that affect the environment, as well as an assessment of which factors can be reduced;
- set goals for the future - setting specific, measurable and achievable goals that will reduce the impact on the environment;
- develop a green management plan - a description of the specific actions that the organization will undertake in order to achieve the set goals. This plan should contain time frames, responsibilities and necessary resources for the implementation of the plan;
- implementation of green management practices – implementation of specific actions identified in the plan. It can be, for example energy-efficient lighting, use of reusable materials, recycling, waste reduction, etc.;
- monitoring and measuring performance - in order to achieve the goals, it is necessary to measure the environmental performance. This includes monitoring energy consumption, waste generation and other environmental factors, as well as assessing the financial and operational impact of green management practices;
- communication and engagement - apart from the actual implementation in the organization, it is important that green management becomes part of the organizational culture (yes, the organizational culture is "green"), and it is important to communicate and engage with employees, stakeholders and customers. This includes training programs, awareness raising, regular reporting on environmental performance.

The implementation of green management practices in the organization is shown in Fig. 1.



**Fig. 1.** Implementation of green management practices

The advantages of green management are numerous. Organizations that implement green management and show their commitment to the environment affect cost reduction, through

---

energy savings, stimulate innovation, can discover new sources of income or even create a new ecological product [13]. Organizations that adopt green management practices are also perceived as socially responsible, which has an extremely positive effect on improving reputation and increasing customer loyalty. This implies that a successfully implemented green management practice is a key determinant of an organization's competitive position [10].

In addition to all the mentioned advantages, it should also be pointed out that organizations face numerous challenges when implementing green management. Those challenges are primarily reflected in the initial costs, which include investment in new technology, infrastructure, and training. Then, the resistance to changes that occurs among employees, especially the elderly or those with a lower level of education who are not ready to learn new things. Then the complexity of the actual implementation and application of green management practices, because it requires changes in several areas of business [7]. Certainly, organizations that apply the above-mentioned steps of implementing green management will have a better market positioning in the future.

## **GREEN ORGANIZATIONAL CULTURE**

### **Concept and importance of green organizational culture**

Climate change, global warming, technological progress, increased industrial activity have made organizations reconsider and transform their activities and processes towards environmental responsibility. To address environmental issues, organizations must focus on adopting environmental practices [14]. In order for the implementation of green management practices to be successful, it is necessary to transform the organizational culture into a green organizational culture. Organizational culture refers to common values, beliefs, principles that guide the behavior of employees [15]. The adoption of green practices throughout the organization results in the transformation of the organizational culture into a green organizational culture. The definition of green organizational culture is adapted to the definition of organizational culture. It refers to common assumptions, symbols, rituals and social patterns, which influence the behavior of employees in the organization. It consists of a combination of standards and common values that are consistent with the characteristics of the organization [16, 17, 18]. Terms to describe the concept of green organizational culture are diverse, such as: environmentally friendly organizational culture, environmentally friendly culture, sustainability-oriented culture, etc., which are mainly based on the extension of organizational culture to the green context [19]. Therefore, green organizational culture is defined as shared values, beliefs, norms, attitudes, symbols and social stereotypes about organizational management of the environment and shape the standard behavior expected from the individual [15]. Green organizational culture is the extent to which the assumptions, values, symbols and artifacts of an organization reflect the desire or need to operate in a sustainable manner [20].

An ecologically oriented organizational culture depends on several factors. The implementation of green values to the greatest extent is conditioned by the support of the top management [21]. A green culture develops in an organization if employees are focused on the environment and engage in activities that minimize the impact on the environment. Environmentally focused cultural changes result in new ideas and perspectives, leading to a sustainable organization [18]. To promote a green organizational culture and remain sustainable, organizations are focusing on adopting environmentally friendly practices. The task of managers in such organizations is to ensure that all employees attach great importance to the policy of environmental protection and sustainability, through various environmental protection activities. The human resources management sector plays a very important role in the implementation and development of a green organizational culture [22]. Green human resource management implies practical activities, such as: green recruitment and selection, green training and development, green performance management, green salary and compensation for the general mission and goals of the organization's green

management. Green human resource management should create a green organizational culture, because key values, beliefs and behaviors of employees are found and acquired during recruitment, training, evaluation and reward systems [22, 23].

There are many tangible and intangible benefits from an organizational culture that is environmentally and socially responsible and committed to sustainability. Green teams and green initiatives have been shown to improve employee engagement and morale. Research has shown that happy and engaged employees are more productive, more loyal to the organization and more active in the community [24]. Green organizational culture strives to protect consumers and the environment, through the production of clean (ecological) products, saves energy, uses clean technology and minimizes waste [19]. Green organizational culture represents a source of competitive advantage for the organization because it focuses on the preservation of natural resources and the minimization of waste materials, which creates a positive image for the organization on the market. In addition, this kind of organizational culture is difficult to imitate, so it is unique in the market [25].

### **Green organizational culture, green innovation and environmental performance**

One of the variables that has a great impact on green innovation is green organizational culture. A well-defined green culture of an organization facilitates and encourages green innovation [1]. Green innovations are innovations in products and production processes, which help to reduce the negative impact and affect the preservation of the environment [25]. Green innovation emphasizes how the organization can reduce its negative impact or improve the impact on the environment that innovations in the organization, production processes and products. These innovations are most often new or modified product processes, systems and practices that contribute to environmental sustainability [26, 27]. Thus, green or sustainable innovation can be applied to the design of products, processes and technologies related to energy saving or in processes that promote energy efficiency. Green product innovation represents a completely new or modified product, which has improved basic characteristics, technical specifications or any other components that affect energy saving, changing pollution emissions and enabling its recycling [4]. Green organizational culture positively influences the attitudes of managers and employees towards green innovation. In organizations with a strong green organizational culture, managers will strive to develop and implement green innovations as part of their environmental protection policies and practices [25, 28].

A green organizational culture leads to a change in the way of thinking in the organization. Environmental protection is more valued, and it can be said that a green organizational culture has a positive effect on environmental performance. Environmental performance measures the company's performance by taking into account factors such as the reduction of emissions of harmful gases, waste, pollution, improved recycling, economy in the use of resources, etc. [29]. Environmental performance helps an organization save costs through reduced energy consumption and compliance with environmental laws and regulations. Also, it makes it possible to avoid fines from governments for non-compliance with environmental regulations, fulfill the environmental requirements of interested parties, including customers and shareholders, and positively contribute to the ecological balance [18].

Organizations that have a well-designed green organizational culture can dynamically improve their green innovation. This can be achieved through innovations that minimize waste and pollution and reduce energy consumption. Thereby, they influence the improvement of the environmental performance of the organization. Thus, it can be said that a green organizational culture promotes green innovation and improves the environmental performance of the organization [27].

### **CONCLUSION**

Organizations operating nowadays are increasingly oriented towards environmental protection. On the demand side are customers, who increasingly turn their preferences

towards more environmentally friendly products, while on the other hand, environmental protection laws and standards are at a much higher level. In order to respond to these demands, organizations must "green" their operations. As one of the solutions, the transition to green management is offered. By switching to green management, organizations through their management are more careful about saving energy and reducing waste and pollution, thus saving money, but also better positioning themselves on the market. It is very important that by implementing green management it becomes part of the organizational culture of the organization. This also means that the organizational culture becomes green. A green organizational culture is a source of competitive advantage because it is unique and difficult to imitate. Organizations with a strong green organizational culture encourage green innovation and thereby influence green performance. In order for organizations to "green" their management and organizational culture, certain funds (initial investments) are needed, and this is exactly what prevents many from executing this plan. Various state incentives can be offered as a solution, such as financial incentives, tax breaks, loans with lower interest rates, and similar.

## REFERENCES

- [1] Aina, M., Bustaram, I., Amar, S. S., Linarsih, Y., Norsain, The Role of Green Culture Organizations in realizing Green Innovation, Green Performance and the Micro, Small and Medium Enterprises Sustainable Competitive Advantage, *International Journal of Multicultural and Multireligious Understanding (IJMMU)* Vol. 9, No. 10, 2022.
- [2] Yu, W., Ramanathan, R., Nath, P., Environmental pressures and performance: an analysis of the roles of environmental innovation strategy and marketing capability, *Technological Forecasting and Social Change*, Vol. 117, pp. 160-169, 2017.
- [3] Hoffman, A. J., *Competitive Environmental Strategy: A Guide to the Changing Business Landscape*, Island Press, Washington DC, USA, 2017.
- [4] Chandra, K., Arafah, W., Basri, Y. Z., Analysis of the Effect of Green Organizational Culture on Organizational Performance and Competitive Advantages of Green through Green Innovation in Manufacturing Industries, *Journal of Hunan University (Natural Sciences)* Vol. 48., No. 6., 2021.
- [5] Raut, R. D., Luthra, S., Narkhede, B. E., Mangla, S. K., Gardas, B. B., Priyadarshinee, P., Examining the performance oriented indicators for implementing green management practices in the Indian agro sector, *Journal of Cleaner Production*, Vol. 215, pp. 926-943, 2019.
- [6] Sulich, A., *The Green Management, Vision 2025: Education Excellence and Management of Innovations through Sustainable Economic Competitive Advantage*, 2021.
- [7] MBA Knowledge Base, What is Green Management?, <https://www.mbaknol.com/modern-management-concepts/what-is-green-management/> [accessed on 25.09.2023]
- [8] Qi, G., Zeng, S., Li, X., Tam, C., Role of internalization process in defining the relationship between ISO 14001 certification and corporate environmental performance, *Corporate Social Responsibility and Environmental Management*, Vol. 19 No. 3, pp. 129- 140, 2012.
- [9] Chen, Y. S., Lai, S. B., Wen, C. T., The influence of green innovation performance on corporate advantage in Taiwan, *Journal of Business Ethics*, Vol. 67 No. 4, pp. 331-339, 2006.
- [10] Aggarwal, P., Agarwala, T., *Green Organizational Culture: An Exploration of Dimensions*, *Global Business Review*, 2021.
- [11] Lun Venus, Y. H., Green management practices and firm performance: A case of container terminal operations, *Resources, Conservation and Recycling*, Vol. 55, Iss. 6, pp. 559-566, 2011.



- [12] Sulich, A., Green Management in Sustainable Economic Development, Proceedings of the Conference Green & Digital Cities Business, Engineering, Art, Architecture, Design, Political Science & Technology, pp. 108-120, 2019.
- [13] Mind Tools Content Team, Green Management, <https://www.mindtools.com/aevwa71/green-management> [accessed on 25.09.2023.]
- [14] Paillé, P., Chen, Y., Boiral, O., Jin, J., the impact of human resource management on environmental performance: an employee level study, *Journal of Business Ethics*, Vol. 121, No. 3, pp. 451-455, 2014.
- [15] Schein, E. H., *Organizational culture and leadership*, John Wiley, 1992.
- [16] Chang, C. L. H., Lin, T. C., The role of organizational culture in the knowledge management process, *Journal of Knowledge Management*, Vol. 19, No. 3, pp. 433–455, 2015.
- [17] Norton, T. A., Zacher, H., Ashkanasy, N. M., Pro environmental organizational culture and climate, In J. Barling, & J. L. Robertson (Eds.), *The psychology of green organizations*, Oxford University Press, pp. 332-348, 2015.
- [18] García-Machado, J. J., Martínez-Ávila, M., Environmental performance and green culture: The mediating effect of green innovation. An application to the automotive industry, *Sustainability*, Vol. 11, No. 18, 2019.
- [19] Liu, X., Lin, K-L., Green Organizational Culture, Corporate Social Responsibility Implementation, and Food Safety, *Frontiers in Psychology*, Vol 11, 2020.
- [20] Harris, L. C., Crane, A., The greening of organizational culture: Management views on the depth, degree and diffusion of change, *Journal of Organizational Change Management*, Vol. 15, No. 3, pp. 214–234, 2002.
- [21] Afum, E., Agyabeng-Mensah, Y., Owusu, J. A., Translating environmental management practices into improved environmental performance via green organizational culture: Insights from Ghanaian manufacturing SMEs, *Journal of Supply Chain Management System*, Vol. 9, No. 1, pp. 31–49, 2020.
- [22] Amini, M., Bienstock, C. C., Narcum, J. A., Status of corporate sustainability: A content analysis of Fortune 500 companies, *Business Strategy and the Environment*, Vol. 27, No. 8, pp.1450–1461, 2018.
- [23] Khammadee, P., Ninaroon, P., The effects of green human resource management, green organizational culture and green service innovation on environmental performance, *Journal of Positive School Psychology*, Vol. 6, No. 3., pp. 9741-9747, 2022.
- [24] Bill Zujewski, *Green Culture Guide: How to Build a Workforce Committed to Sustainability*, 2022, <https://greenbusinessbureau.com/green-practices/employees/green-culture-guide-how-to-create-a-workforce-committed-to-sustainability/> [accessed on 25.09.2023]
- [25] Küçükoglu, M.T., Pinar, R.I., Positive influences of green innovation on company performance, *Procedia - Social and Behavioural Sciences*, Vol. 195, pp. 1232-1237, 2015.
- [26] Wang, C. H., How organizational green culture influences green performance and competitive advantage: The mediating role of green innovation, *Journal of Manufacturing Technology*, Vol. 30, No. 4, pp. 666-683, 2019.
- [27] Gürlek, M., Tuna, M., Reinforcing competitive advantage through green organizational culture and green innovation., *Service Industries Journal*, Vol. 38, No. 7-8, pp. 467-491, 2018.
- [28] Fatoki, O., Green organizational culture and environmental performance: The role of green innovation, *Journal of Legal, Ethical and Regulatory Issues*, Review Article, Vol. 24, Iss. 6S, 2021.
- [29] Hadjri, M., Perizade, B., Farla, W, Organizational culture, and environmental performance: An empirical study, *Proceedings of the 2019 International Conference on Organizational Innovation (ICOI 2019)*, 2019.



## DIGITAL INNOVATIONS AND DIGITAL TRANSFORMATION OF BUSINESS ORGANIZATIONS

**Biljana Maljugić<sup>1</sup>, Srđana Taboroši<sup>1</sup>, Dijana Tadić Stanić<sup>1</sup>, Marija Matotek Anđelić PhD<sup>2</sup>, Nenad Dajić<sup>3</sup>**

<sup>1</sup>University of Novi Sad, Technical Faculty "Mihajlo Pupin", Zrenjanin, Serbia

<sup>2</sup>Technical College of Applied Studies in Zrenjanin, Republic of Serbia

<sup>3</sup>Gradska narodna biblioteka Žarko Zrenjanin, Zrenjanin, Serbia

e-mail: [biljanamaljucic28@gmail.com](mailto:biljanamaljucic28@gmail.com)

**Abstract:** Digitized society sets more and more demands for the development of digital innovations. The paper presents the role of digital innovations, as well as integrated solutions aimed at digital transformation. Increasing business performance, competitiveness and sustainability of the company is achieved by establishing new business models. Digital transformation is based on the interaction of digital technologies, business and society. In the digital environment, attention is focused on innovations in the protection and security of big data.

**Key words:** Digital Technologies, Digital Innovation, Digital Transformation, Business Organizations

### INTRODUCTION

Technological progress in the daily activities of the human population brings certain conveniences, benefits, increasing satisfaction in products, services, faster access and accessibility to needs. The effects of technological progress affect the prestige, development and sustainability of business organizations. For these reasons, there is an increasing necessity for digital innovations and digital transformations of companies. Digital technologies provide the possibility of adapting and improving the infrastructure in the application of Information Technologies (IT). In this way, digital technologies create space for the development of digital innovations in the direction of changes in business processes, business systems, structures, IT architecture, i.e. digital transformation of companies.

Drechsler et al. [1] state that digital innovations do not take place only in the direction of connecting new elements of organization and technology, as was the case until now. Today, companies use digital innovations to introduce significant changes in previous elements, such as the establishment of a hierarchical structure, organizational culture, competencies, and resources. Digital innovations affect changes in processes that comprehensively lead to the digital transformation of a business organization [1].

### DIGITAL INNOVATIONS

#### Defining Digital Innovation

Khin and Ho [2, p. 5] define digital innovation as "the development of new products, services, or solutions by using digital technology". Big Data (BD), Internet of Things (IoT), Cloud Computing, augmented and virtual reality, artificial intelligence and cyber-physical systems are digital technologies that are applied in innovation. In general, digital innovations using digital technologies are recognized in the creation of market offers of business processes and models. With their research, Khin and Ho [2] confirmed that digital orientation and digital capability have positive effects on digital innovations and thus improve the financial and non-financial performance of companies.

Software is the most important component in driving and diversifying digital innovation. It is the basis of certain processes, products or services. Given the rapid changes in the digital and economic environment, the diffusion of digital innovations besides IT includes other companies and industries. Successful innovative digital achievements can be singled out, as for example according to Ciriello et al. [3] in the automotive industry Tesla Inc. In which digital technologies are used for wireless software updates and remote diagnostics to automatically identify problems and book service center appointments [3].

The explanation of digital innovations is related to the digitization of information that can be transformed and transferred to any devices. By further reprogramming, digital information can be adapted into new digital solutions. So the basis of digital technologies with high scalability and low entry barriers creates unlimited space for the development of digital innovations [3]. In the digital connection of products and services. In the field of marketing in the creation of value through digital innovations of network cooperation between users, suppliers, customers. In service system engineering, analytics and automation, robotic process automation are just some of the possibilities of digital transformation into service design innovations [3].

### **The Role of Digital Innovations**

In an extensive review of the scientific literature, Di Vaio et al. [4] confirmed that, in a long-term perspective, tools for digital transformation contribute to the process of value creation, the sustainability of business entities through digital innovations through Knowledge Management Systems (KMS). The implementation of digital tools (IoT and BD) in KMS improves corporate management and provides a competitive advantage. The role of KMS is significant in the allocation and sharing of knowledge, in the optimization of technology and resources, support in making important strategic and management decisions, as well as in measuring the company's impact on the environment, which is very important in the perception of stakeholders, good reputation and sustainable business operations of the company.

In the context of Industry 4.0. digitization of production and business processes brings certain benefits in the productivity of the company [5, 6], resource efficiency and waste reduction [5], innovation performance [6], with the fact that attention must also be directed to the labor market [5, 7] and preservation of the environment [5]. Adapt the education process to Industry 4.0 and educate staff for new market needs [7]. In every sense, sustainability should be viewed from the economic, social and ecological aspects [5].

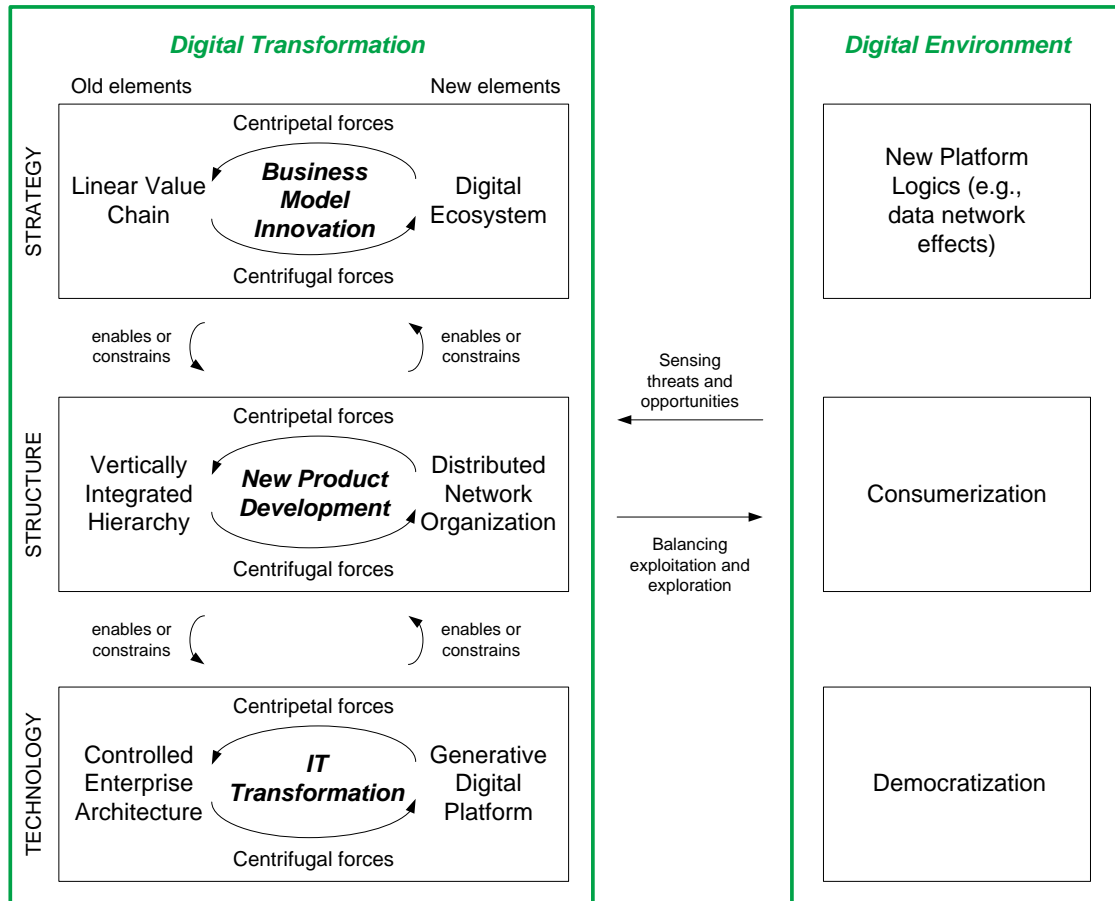
Industry 4.0 favors the development of social and technological innovations, but it reduces the lifespan of products. In order to accelerate the development of innovations without relying only on internal resources, some companies establish open innovation strategies and cooperation with external stakeholders. Digital trust is very important in this endeavor [6].

### **DIGITAL TRANSFORMATION**

In the creation of digital transformation, the driving force of innovation, i.e. IT consumers from the digital environment, stands out. The phenomenon of IT consumption was defined by Gregory et al. [8] according to Drechsler et al. [1, p. 6] as "the process whereby the changing practices and expectations of consumers, shaped by the wide adoption of digital technologies in everyday life, will influence the IT-related activities of workers and managers in organizations". Consumers, both employees and customers, users of digital technologies encourage digital innovations through interactions. With their demands, they affect the transformation of the company's elements. On strategy, structure, culture, technological platforms. In addition to the aforementioned statements, one part of the specificity of digital contamination is democratization, which due to greater competition is characterized by an increase in the number of startup ventures, as well as a new business logic created by companies [1, p. 6].

Digital transformations of companies imply the acceptance of new elements by all members of the organization, the introduction of a new business model. In the implementation,

organizational learning is necessary for the successful implementation of changes and the transition from old elements to new elements of technology and organization [1]. Establishing a balance between the mentioned old and new elements within the company, with the aim of successful digital transformation, was the topic of discussion at the round table session of the Professional Development Workshop (PDW) at ICIS 2019 in Munich, Germany [1]. Figure 1. presents a graphic representation of the required resources for digital transformation within the company due to external factors of the digital environment.



**Fig. 1.** Digital Transformation from the Standpoint of an Incumbent Firm  
 Source: [1, p. 6]

The experts concluded that the model presented in Figure 1. is appropriate at the level of a business organization, but that digital innovations should be viewed more broadly, from the perspective of the transformation of the entire society [1].

Nadkarni and Prügl [9] present similar views, that for changes in the company and effective digital transformation, new business models, organizational structure, technology and people are equally important. Digital transformation can be seen as one of the challenges for company managers, and the answers can be found in quality digital opportunities and qualified personnel, skills development [9].

The authors Van Veldhoven and Vanthienen [10] with their research and the "Three axes" framework (Figure 2.), show that digital transformation can be observed through the interaction of changes in: digital technologies, business and society.

The axis of digital technologies follows the main developments of technologies and the chronology of transformation management [10], so that today development activities take place with integrated solutions, applications for connecting large amounts of data, analytics, cloud computing, and the Internet of Things (SMACIT) [10, 9], with further development

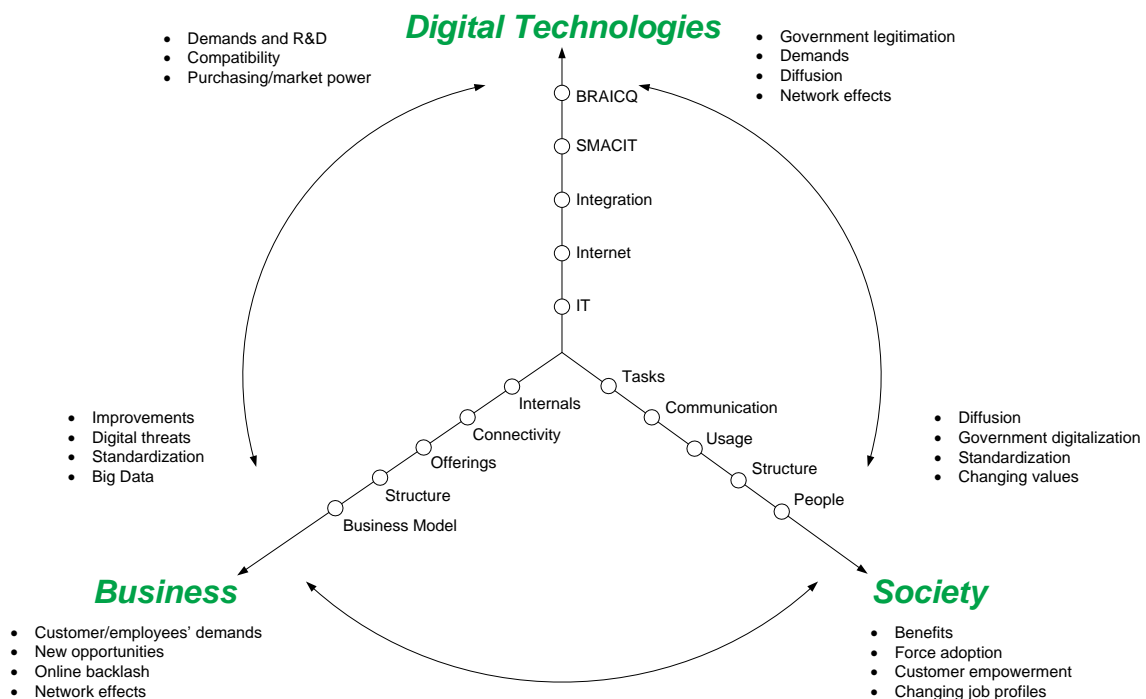
opportunities in the areas of blockchain, robotics, Artificial Intelligence (AI) and Cognitive and Quantum Computing (BRAICQ) [10].

In a digitized society, changes in business follow the progress of digital technologies, so that due to these influences, business is increasingly improved. From automated systems and digitized processes to digital products and services. Which confirms the increasing number of digital innovations in creating resilience and agility of companies for business in a changing market. The digital transformation of companies takes place from adapted organizational structures to the establishment of new business models [10].

New technologies, so-called cross-boundary digital technologies (such as IoT, 3D printing, Big Data Analytics) initiate the transformation of companies with the application of significant changes in business models, strategy, culture, industrial structure and thus go beyond the internal optimization of business processes. Furthermore, with the need to integrate into the organizational architecture of the company, it is necessary to enable adequate integration of technology (agile digital infrastructure: flexible IT structure, platforms, scalability) and transformation [9].

Observing society, it is noticed that digitalization, with its rapid rise, has brought changes in activities in people's private lives and in the work environment. In communication, in the daily needs of citizens, in the use of digital products and services, faster access and distribution of products, to performing certain tasks and working from home [10].

A graphic representation of the digital transformation framework based on the interaction of digital technologies, business and society is presented in Figure 2.



**Fig. 2.** The interaction-based digital transformation framework  
 Source: [10, pp. 629-644]

## Data Protection

In the perspective of further development of technology and society, the necessity of improving cyber-security and data protection appears. With digitization, the storage of big data relies on cloud technology. Big data management is subject to risks from different data access capabilities. For these reasons, data security management has the epithet of digitization priority.

Rawat et al. [11] through an extensive research of the literature of scientific research papers, pointed out how big data can be protected in the field of Cybersecurity. Awaysheh et al. [12] presented a new framework for big data security through knowledge mapping in Cloud Computing (BigCloud).

Digital technologies have made progress and brought many benefits to the healthcare sector. However, the question arises of the security of big data of healthcare systems, which have recently been increasingly burdened by cyber threats. One of the proposed solutions is the Fuzzy Analytic Hierarchy Process (Fuzzy AHP) because it has been shown to be more efficient than the classic AHP and a more sustainable approach for assessing the security of big data [13].

There are security solutions for possible threats and vulnerabilities in the banking sector. Models that would enable greater protection of electronic signatures, with a proposal for greater security of the Smart Online Banking System (SOBS) for the application of biometric fingerprints that would reduce possible threats to the lowest possible level [14].

## CONCLUSION

The time of Industry 4.0 and modern business processes have reduced the physical and at the same time improved the mental work of people. The consequences of Industry 4.0, such as comments "job loss" and old habits, make up for changes, which are inevitable in the development of technology and human society, turning everything old and lost into new and better.

The authors Khin and Ho [2] emphasize the importance of implementing digital solutions in order to better digital transformation of business organizations and industries, as well as improving business performance in the environment of the digital economy.

Not a small number of companies and enterprises, which have digital and human resources, conduct business outside their home locations in order to communicate faster and reduce costs. Carrying out work tasks remotely or from home is increasingly common in business practice [15].

Digital technologies are an inexhaustible resource for creating digital innovations. With technological progress, the development of digital tools, software, digital communications, digital products and services, consumers - digital society create a better quality of life for themselves with all the benefits of human intelligence.

## REFERENCES

- [1] Drechsler, K., Gregory, R., Wagner, H. T., Tumbas, S., At the crossroads between digital innovation and digital transformation, Communications of the Association for Information Systems, Vol. 47, No. 1, p. 23, 2020.
- [2] Khin, S., Ho, T. C., Digital technology, digital capability and organizational performance: A mediating role of digital innovation, International Journal of Innovation Science, Vol. 11, No. 2, pp. 177-195, 2018.
- [3] Ciriello, R. F., Richter, A., Schwabe, G., Digital innovation, Business & Information Systems Engineering, Vol. 60, pp. 563-569, 2018.

- [4] Di Vaio, A., Palladino, R., Pezzi, A., Kalisz, D. E., The role of digital innovation in knowledge management systems: A systematic literature review, *Journal of business research*, Vol. 123, pp. 220-231, 2021.
- [5] Ghobakhloo, M., Industry 4.0, digitization, and opportunities for sustainability, *Journal of cleaner production*, Vol. 252, p. 119869, 2020.
- [6] Mubarak, M. F., Petraite, M., Industry 4.0 technologies, digital trust and technological orientation: What matters in open innovation?, *Technological Forecasting and Social Change*, Vol. 161, p. 120332, 2020.
- [7] Tadić, D. M., The impact of Industry 4.0 on changes in education, *Tehnika*, Vol. 77, No. 2, pp. 257-263, 2022.
- [8] Gregory, R. W., Kaganer, E., Henfridsson, O., Ruch, T. J., IT Consumerization and the Transformation of IT Governance, *MIS Quarterly*, Vol. 42, No. 4, pp. 1225–1253, 2018.
- [9] Nadkarni, S., Prügl, R., Digital transformation: a review, synthesis and opportunities for future research, *Management Review Quarterly*, Vol. 71, pp. 233-341, 2021.
- [10] Van Veldhoven, Z., Vanthienen, J., Digital transformation as an interaction-driven perspective between business, society, and technology, *Electronic Markets*, Vol. 32, No. 2, pp. 629-644, 2022.
- [11] Rawat, D. B., Doku, R., Garuba, M., Cybersecurity in big data era: From securing big data to data-driven security, *IEEE Transactions on Services Computing*, Vol. 14, No. 6, pp. 2055-2072, 2019.
- [12] Awaysheh, F. M., Aladwan, M. N., Alazab, M., Alawadi, S., Cabaleiro, J. C., & Pena, T. F., Security by design for big data frameworks over cloud computing, *IEEE Transactions on Engineering Management*, Vol. 69, No. 6, pp. 3676-3693, 2021.
- [13] Attaallah, A., Alsuhabi, H., Shukla, S., Kumar, R., Gupta, B. K., Khan, R. A., Analyzing the Big Data Security Through a Unified Decision-Making Approach, *Intelligent Automation & Soft Computing*, Vol. 32, No. 2, 2022.
- [14] Ghelani, D., Hua, T. K., Koduru, S. K. R., Cyber Security Threats, Vulnerabilities, and Security Solutions Models in Banking, *Authorea Preprints*, 2022.
- [15] Taborosi, S., Poštin, J., Terek Stojanović, E., Rajković, J., Berber, N., Nikolić, M., The Influence Of Cultural and Personal Properties on Job Performances and Organizational Commitment In Teleworkers, *The South East European Journal of Economics and Business*, Vol. 18, No. 2, pp. 1-20, 2023.





## ONLINE MARKETING AUTOMATION WITH PYTHON-BASED SOCIAL BOT

Vuk Amižić<sup>1</sup>, Ljubica Kazi<sup>1</sup>, Dalibor Šeljmeši<sup>1</sup>, Jovana Borovina<sup>1</sup>

<sup>1</sup>University of Novi Sad, Technical Faculty "Mihajlo Pupin", Zrenjanin, Serbia

<sup>1</sup>e-mail: [vuk.amizic@tfzr.rs](mailto:vuk.amizic@tfzr.rs)

**Abstract:** This work represents a short review of techniques in online marketing, online marketing automation and use of web scrapers in order to increase the reach of customers, increase sales and profit as well as making fully functional online bot whose goal is to log into Instagram, post, comment and follow targeted audience.

**Key words:** online marketing automation, web driver, web scraping, digital marketing, social media marketing, social media bot

### INTRODUCTION

Online marketing plays a key role for selling various types of products. It is of great importance to find target audience and keep them interested in your products. With help of technology and social media, reaching desired audience can be very fast and productive. Besides the advertisements and promotions, keeping the possible customers engaged with social media seller profile can be profitable and boost the overall popularity and income of the store. Limited by the time and human resources, the automation of social media profiles can be achieved in order to keep in touch with customers, expand the area of influence, save time and cut the expenses needed to run the business.

One way for online marketing automation can be achieved through selenium web driver, whose goal could be predefined to serve as automated application in order to scrape the web and social medias, to reach, engage and promote business owner's store.

### RELATED WORK

According to [1], online marketing is also called internet marketing and e-marketing, and it includes several methods and techniques such as online advertising, email-marketing, search engine optimization, affiliate marketing, social media marketing and viral marketing.

According to [2], one of the most important topic companies should focus on is the customer behaviour, because it is necessary to understand how customers evaluate and make decisions.

According to [4], web scraping can be useful to keep an eye on various things such as competitor's prices.

According to [5], social media provide marketers with the ability to target audiences and consumers based on site users' personal interests and what their friends like.

According to [7], Indeed, online social networks have profoundly changed the propagation of information by making it incredibly easy to share and digest information on the internet.

According to [8], 600 million potential customers are on Facebook, retailers are flocking to the site and aggressively experimenting with new communication strategies.

According to [8], five ways to of connecting to customers via Facebook are

- Promotions
- Crowd sourcing
- Check-ins
- Games

- Social shopping

According to [10], online marketing consists of many different types of campaigns such as:

- Search Engine Optimisation (SEO)
- Search Engine Marketing (SEM)
- E-mail marketing
- Content marketing
- Trade shows
- Social media
- Website

According to [10], marketing automation gives the ability of tracking every part of content, storing info about people who engage with content as well as ability to gather and build database of people who engaged with content of the seller.

According to [11], universal access to the Internet, advancement of new technologies, expansion of mobile gadgets and continuously changing marketing models all combine to emphasise the need for integrated marketing automation systems in running effective promotion campaigns.

According to [11], Marketing automation platforms include systems for customer relationship management and sales lead management as well as other analytical platforms for monitoring and evaluation of marketing campaigns.

According to [12], The central component of any marketing automation solution is the client repository. This holds information on prospects, customers and ex-customers, allowing the relationship with the individual to be managed through each stage in the customer life cycle.

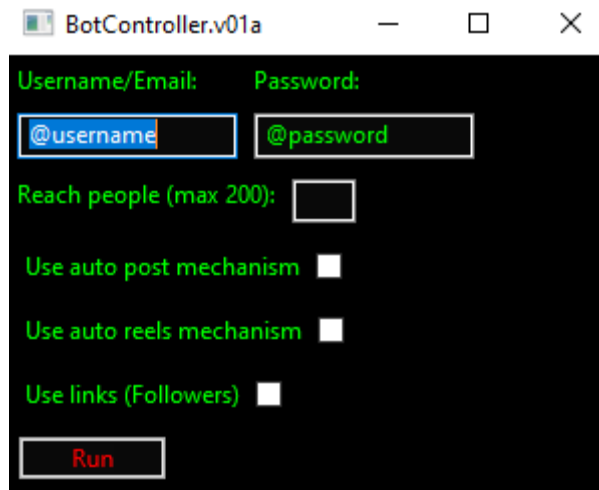
According to [13], One of the bottlenecks of marketing automation is the restricted availability of tech and data experts. Therefore, the industry increasingly provides "no code" or at least "low code" solutions for setting up automation plans. "No code" means that the user needs no programming skills; "low code" refers to few programming skills

## **THE PROPOSED SYSTEM**

### **Usability and user interface**

The goal of the SocialBot software is to achieve fast and reliable content management and engagement with users over the social media such as Instagram. Key features are ability to log in, post comments, posts and follow other Instagram users based on the provided .CSV file that stores targeted Instagram accounts.

User interface for the proposed system of online marketing automation consists of several important options designed for fine tuning and tweaking of the desired target audience and several different types of the engagement with possible customers.



*Fig. 1. User interface*

Key features of user interface consists of several important elements required for social media automation bot to work properly and those are:

- Username/Email
- Password
- Number of people to reach
- Auto post feature
- Auto reels feature
- Use links feature

Fields for **username** and **password** refer to valid instagram account.

The **number of people to reach** means the actual number of follow requests to be sent to targeted audience via user prompted links, which are stored in a separated CSV file.

**Auto post mechanism**, as well as **auto reels mechanism** represents TBD feature whose goal is to automate posting of pictures, videos and offers of various product types.

Use links feature consists of simple coma separated value file which includes user given links to various instagram accounts, form where the followers will be gathered and engaged.

Once the parameters are set, the user can click with left mouse button on the "Run" button from the user's interface, and application will start running.

## Implementation

Implementation of the online marketing automation application consists of several important segments:

- Controller.py
- SocialBot.py code
- comments.csv
- followerssource.csv

Controller.py presents the code for the user interface where shapes of windows, input fields, labels, buttons and button functions are defined as well as validation mechanism. It is required to perform validation checks, and prepare input parameters for further actions.

```
#Main window finalisation

theBox.Add(RowA, flag=wx.ALL, border=1)
theBox.Add(RowB, flag=wx.ALL, border=1)
theBox.Add(ColumnC, flag=wx.ALL, border=1)

self.panel.SetSizer(theBox)

self.Centre()
self.Show()

def Run(self, e):
    #Release the beast
    self.widget = e.GetEventObject()
    print('Username/Email:', self.usernameInput.GetValue())
    print('Password:', self.passwordInput.GetValue())
    print('Reach out people:', self.ReachPeopleInput.GetValue())

def BlockAscii(self, e):
    key=e.GetKeyCode()
    if ord('0') <= key <= ord('9') or key in (8, 127, 235, 314, 316):
        limit=200
        userInput=self.ReachPeopleInput.GetValue()
        #print(userInput)
        e.Skip()

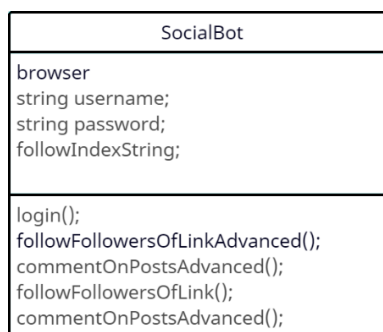
app=wx.App()
window=Window("BotController.v01a")
app.MainLoop()
```

**Fig. 2.** Part of Controller.py

After defining user interface, it is necessary to develop a good object oriented model which will be the actual SocialBot.py whose functions are focused to scrape the web and instagram with previously assigned parameters trough Controller.py and CSV files.

Key functions of the SocialBot are:

- login function
- followFollowersOfLinkAdvanced function
- commentOnPostsAdvanced function
- followFollowersOfLink function
- commentOnPostsAdvanced function



**Fig. 3.** SocialBot Class model



Web scraping is commonly achieved through XPath scraping. The language of XPath itself is designed to select nodes and compute values from an XML and HTML document, and is the one of the languages that allows extraction of web data.

Handling of XPath is done by presenting the XML or HTML document as a tree, where the root node is not the part of the document itself, but the parent of the document's element node of <html> tag, in case of HTML document.

In order to perform successful XPath web scraping, it is required to analyze desired website and write algorithm good enough to perform desired actions, but also to handle the errors that could be encountered in case of updated classes and id's of the targeted website that are needed for XPath to work correctly.

According to [6] geckodriver used through Selenium requires Selenium version of 3.11 or greater, due to implementation of **W3C WebDriver standard** instead of Selenium's old wire protocol which is used by older drivers.

Interface of the SocialBot is achieved through wxPython. According to [9], wxPython is a cross-platform GUI toolkit for the Python programming language. It allows Python programmers to create programs with a robust, highly functional graphical user interface, simply and easily. It is implemented as a set of Python extension modules that wrap the GUI components of the popular wxWidgets cross platform library, which is written in C++.

CSV files, also known as "Comma Separated Values" are files which can be easily edited and used in various different types of programming and scripting languages. They are lightweight and easy to read, which can boost productivity and adaptation to different scenarios. Besides the input parameters, they can serve as storage for specific mined data, which can help with further analytics of performed actions over desired websites, social media accounts and engagements with followers.

## CONCLUSION

SocialBot project can save both time and money while engaging with real world customers, which can result in increased sales, better time management and overall automation process of several different selling account of various social media platforms. While engaging with different social media accounts and possible customers, a data mining operation can be performed to identify patterns and relationships that can help to solve business problems through data analysis, and boost sales.

SocialBot can be upgraded to support more browsers and social media platforms, and perform more human-like actions when posting and commenting over the internet. Interface can be redesigned to be more user-friendly, with improved validations and features for more complex and advanced targeting. Further tweaking of SocialBot speed of actions can help to prevent flagging IP addresses as bot proxy network, which will prevent possible ban of the social media accounts.

## REFERENCES

- [1] Bostanshirin, Soheila. "Online marketing: challenges and opportunities." Proceedings of SOCIOINT14-International Conference on Social Sciences and Humanities, Istanbul, September. 2014.
- [2] Schwarzl, Susanne, and Monika Grabowska. "Online marketing strategies: the future is here." Journal of International Studies 8.2, 187-196, 2015.
- [3] Nyamathulla, S., P. Ratnababu, and Nazma Sultana Shaik. "A Review on Selenium Web Driver with Python." Annals of the Romanian Society for Cell Biology, 16760-16768, 2021.
- [4] Lawson, Richard. Web scraping with Python. Packt Publishing Ltd, 2015.
- [5] Nadaraja, Rubatheer, and Rashad Yazdanifard. "Social media marketing: advantages and disadvantages." Center of Southern New Hampshire University, 1-10, 2013.

- [6] Gecko web driver for web automation with mozilla firefox web browser: <https://firefox-source-docs.mozilla.org/testing/geckodriver/index.html>
- [7] Opreana, Alin, and Simona Vinerean. "A new development in online marketing: Introducing digital inbound marketing." *Expert Journal of Marketing* 3.1 (2015).
- [8] Saravanakumar, Murugesan, and T. SuganthaLakshmi. "Social media marketing." *Life science journal* 9.4, p.p. 4444-4451, 2012.
- [9] wxPython: <https://wxpython.org/index.html>
- [10] Sweezey, Mathew. *Marketing automation for dummies*. John Wiley & Sons, 2014.
- [11] Świeczak, Witold. "Marketing automation processes as a way to improve contemporary marketing of a company." *Marketing Instytucji Naukowych i Badawczych* 3 71-84, 2013.
- [12] Doyle, Shaun. "Software review: The components of a marketing automation solution in a multi-channel real-time environment." *Journal of Database Marketing & Customer Strategy Management* 8, 87-92, 2000.
- [13] Skiera, Bernd. "Challenges of Marketing Automation: Linking MarTech & SalesTech." *NIM Marketing Intelligence Review* 14.2, 11-17, 2022.





## FOSSIL FASHION: TEXTILE MATERIALS FROM THE OIL AND THE ENVIRONMENTAL RESPONSIBILITY

**Valentina Bozoki<sup>1</sup>, Ineta Nemeša<sup>1</sup>, Marija Pešić<sup>1</sup>, Nadiia Bukhonka<sup>1</sup>, Dejan Bajić<sup>1</sup>**

<sup>1</sup>University of Novi Sad, Technical Faculty "Mihajlo Pupin", Zrenjanin, Serbia  
e-mail: [valentina.bozoki10@gmail.com](mailto:valentina.bozoki10@gmail.com)

**Abstract:** In this paper, the significant influence of petroleum on the manufacture of textile materials and its effects on the environment are discussed. Focusing on various facets of this subject, we examine alternative materials and sustainable production methods, investigate the pollution and negative effects of plastics and synthetic fibers on the environment. This paper also explores the global dimension of the problem and the role of innovation and technology in reducing the impact of petroleum materials. Through these thematic analyses, the work calls for awareness raising, consumer education and global cooperation as key factors in achieving a more sustainable use of textile materials and a more responsible attitude towards the environment.

**Key words:** petroleum, textile materials, sustainable

### INTRODUCTION

Oil has evolved into a fundamental component of modern life in the age of pervasive industrial production and the consumer culture. Its function extends well beyond providing energy for our houses and vehicles, deeply affecting many aspects of our everyday life. The textile industry is one of the most noticeable sectors where oil is important. However, with the growing global interest in preserving the natural environment, the question arises about the impact of these materials on the ecology and sustainability of our planet. The bulk of today's clothing is created from fossil fuels; nearly two-thirds (69%) of the materials used to make clothing come from limited resources like crude oil and natural gas. Polyester dominates here, making up more than half (56%) of the textiles we use today, well outpacing nylon, acrylic, and elastane [1]. In the continuation of this paper, we will delve deeper into how petroleum is used to create synthetic textile materials and how these materials affect the environment. We will consider alternatives to petroleum materials, including sustainable materials and recycling. This paper aims to provide a deeper insight into the issue of the impact of oil on textile materials and environmental responsibility and to encourage thinking about the ways in which we can reduce the negative impact of oil materials on our planet and support sustainable fashion.

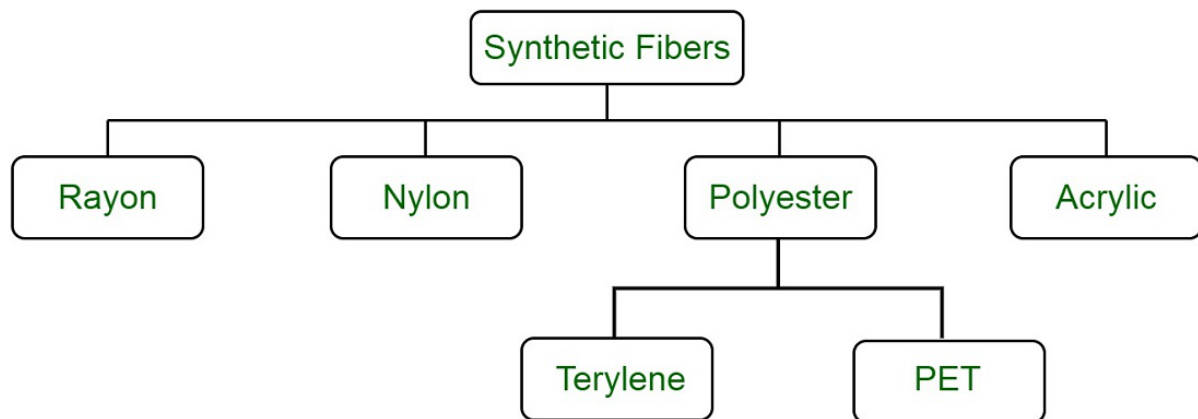
### THE ROLE OF OIL IN TEXTILES

The textile industry, as one of the most important branches of production worldwide, depends on different raw materials to create diverse and functional materials. Among these raw materials, oil plays a key role. Oil is the basic resource for the production of synthetic textile materials such as polyester, nylon (polyamide), acrylic and others. Synthetic materials are popular for their durability, strength and ability to retain their shape [1].

Petrochemicals undergo extensive processing to create synthetics. Most frequently, polymer chips or granules are melted and then extruded to create very long, fine filaments that are wrapped together to make nylon and polyester yarns. PET, which is a byproduct of the production of crude oil and natural gas, is often used to make polyester. The textile industry, which uses 15% of all plastic, is the greatest consumer of plastic after packaging and construction since the majority of garments on the market are made of plastic. As a result, the issue of synthetics is tightly related to the problems with plastics at all points in their lifecycle,

from production to use to disposal, and is also firmly tied to the growing issue of plastic pollution [1].

Nylon, polyester, acrylic, and polyolefin account for around 98 percent of the total volume of synthetic fiber manufacturing, making them the most important synthetic fibers. Polyester alone is given responsibility for 60% of the total. The majority of these fibers are acknowledged as having promise as profitable commercial goods. The categorization of synthetic fibers may be seen in Fig. 1. [2].



*Fig. 1. The categorization of synthetic fibers*

Technical textile materials used in clothing for sports activities, outdoor adventures and military purposes are often made from petroleum derivatives. These materials provide protection from the elements as well as certain performances such as water or fire resistance. In addition to their functional use, petroleum products are frequently employed in the fashion industry to create premium apparel and accessories. Another petroleum-derived substance called elastane gives tights and other items of clothing more elasticity and flexibility. Petroleum-based ingredients are frequently found in the dyes and inks used to print on and decorate textiles [3]. Although petroleum is a crucial component in the development of diverse and useful textile materials, it is vital to take into account its effects on the environment and investigate alternatives that can lessen these effects. In the parts that follow, we will go into further depth about this.

## **ENVIRONMENTAL IMPACT OF SYNTHETICS**

The textile industry, which plays a key role in everyday life, cannot be imagined without the use of various materials. However, in recent decades, synthetic textile materials, which are often produced from petroleum or its derivatives, have become an indispensable part of the fashion industry. Synthetic materials provide durability, functionality and design variety, but their use has a profound environmental impact on our planet.

One of the most significant problems associated with synthetic materials is microplastic pollution. During the production, wearing and washing of clothing made from synthetics, tiny pieces of plastic, known as microplastics, are released into the environment. These microplastics can end up in rivers, lakes and oceans, posing a serious threat to animals that feed on the microscopic organisms and ecosystems as a whole [4].

Microfibers are released from synthetic fabrics during washing, with waste water being the main channel for leakage into the aquatic environment. Microfibers are spread in water, air, and soil throughout the production of textiles, wearing of clothing, and end-of-life disposal, however. Although microfiber shedding lessens with each wash, it also increases with the aging of textiles and the wear and tear on clothing. Fast fashion is therefore responsible for a disproportionately high amount of microfiber release because the majority of its clothing are

made of synthetic fibers and undergo several initial washes due to their short lifespan and rapid deterioration [5].

The production of synthetic textile materials requires large amounts of water and the use of chemicals such as dyes and fixatives. Wastewater from factories often ends up in water bodies, causing water pollution and seriously harming local ecosystems. Polyester, nylon, and spandex are examples of synthetic fibers that are generated from synthetic materials, which are often created by chemical processes. Synthetic fibers are not biodegradable since they are manufactured from polymers that are present in natural gas and petroleum byproducts. These fabrics can be likened to plastic in that they will eventually break down into smaller bits, although it may take them up to 200 years to completely degrade in landfills [6].



*Fig. 2. Microplastics*

The production of synthetic materials requires enormous amounts of energy, often with the use of fossil fuels. This leads to the emission of greenhouse gases and contributes to the global problem of climate change. Most of the world's energy still comes from fossil fuels such as coal, oil and natural gas. Using these resources to power factories that produce synthetic materials generates greenhouse gas emissions, such as carbon dioxide (CO<sub>2</sub>) and methane (CH<sub>4</sub>). These gases contribute to climate change and global warming. The production of synthetic materials often involves processes that require high temperatures and cooling. These processes require a significant amount of energy, especially in factories that use outdated technology [7].

## **SUSTAINABLE PRODUCTION**

As a result of the environmental and social issues connected to traditional textile manufacturing processes, sustainable production has become a crucial topic in the textile industry. With this strategy, we hope to reduce the harm that textile production does to the environment, preserve resources, and support moral and ethical manufacturing practices.

Resource efficiency is one of the guiding concepts of sustainable manufacturing. This entails lowering the amount of energy, water, and raw materials used during production. To reduce waste and resource depletion, textile businesses are increasingly implementing techniques like closed-loop systems, where materials are recycled and reused. The use of environmentally friendly and ethically obtained resources is prioritized in sustainable production. Some examples of sustainable textile materials are organic cotton, hemp, Tencel (produced from wood pulp obtained sustainably), and recycled fibers. These materials frequently follow fair labor standards and are grown or produced in a way that has no negative impact on the environment [8].

Detergents, finishing agents, and dyes used in the creation of textiles can all have a negative impact on the environment. Sustainable production places a strong emphasis on using safe,

non-toxic substitutes and on implementing effective wastewater treatment systems to reduce chemical contamination. Textile producers are increasingly relying on renewable energy sources like solar and wind power to lessen their carbon footprint. Energy-efficient construction is a priority when designing sustainable manufacturing facilities, and several tactics are employed to constantly monitor and reduce carbon emissions [8].

Beyond environmental issues, sustainability in the textile sector also includes moral labor standards. This entails making certain that employees receive fair pay, have safe working conditions, and have their rights upheld throughout the supply chain. In order to do this, ethical certifications like Fair Trade and different labor norms are essential. The shift to a circular economy model is a crucial component of sustainable manufacturing. This entails creating items and materials that can be recycled, repurposed, or reused in order to cut down on waste and increase the lifespan of textiles. Recycling initiatives for clothing and textiles are spreading more widely [9].

For production to be sustainable, there must be transparency across the supply chain. More and more companies are disclosing details on the sources of their raw materials, their production methods, and their dedication to sustainability. Consumers are better able to make educated decisions because to this transparency, which also helps companies that share their



*Fig. 3. Sustainable fashion*

values [9].

In the textile sector, sustainable manufacturing is a multidimensional strategy that takes ethical, social, and environmental concerns into account. The industry can lessen its negative effects on the environment and help to create a future that is more responsible and sustainable by implementing these ideas and practices. It also meets the rising customer demand for environmentally friendly and morally responsible products, making it an essential part of the contemporary textile business [9].

## **CONCLUSION**

The textile industry, as one of the largest and most influential industries in the world, plays a key role in our lives. However, this industry also brings with it numerous environmental and social challenges. The discussion on sustainable fashion and sustainable textile production is a response to these challenges and explores ways in which we can transform this industry towards a more positive impact on the planet and society. Synthetic materials, often derived from petroleum, play a key role in the textile industry, but also have a significant environmental

impact due to microplastics, high energy consumption and the need for chemicals. These materials often form the foundation of many fashion pieces, including clothing, footwear and accessories. Sustainable fashion, on the other hand, is an approach to fashion that focuses on reducing the negative impact on the environment and society. These include the use of sustainable materials, recycling, waste reduction, use of renewable energy and ethical work practices. Sustainable fashion is not only a trend, but also a response to the growing concern of consumers for the planet and people.

## REFERENCES

- [1] FOSSIL FASHION: The hidden reliance of fast fashion on fossil fuels, (2021), Available at: [https://changingmarkets.org/wp-content/uploads/2021/01/FOSSIL-FASHION\\_Web-compressed.pdf](https://changingmarkets.org/wp-content/uploads/2021/01/FOSSIL-FASHION_Web-compressed.pdf)
- [2] Types of Synthetic Fibers, (2021), Available at: <https://www.geeksforgeeks.org/types-of-synthetic-fibers/>
- [3] Milanović, D. (n.y.). Organizational structures. Available at: [http://ie.mas.bg.ac.rs/data\\_store/upload/458\\_hendaut\\_2\\_-\\_prof\\_dr\\_d\\_milanovic.pdf](http://ie.mas.bg.ac.rs/data_store/upload/458_hendaut_2_-_prof_dr_d_milanovic.pdf)
- [4] What Are Synthetics?, (2022), Available at: <https://inthewash.co.uk/laundry-and-ironing/what-are-synthetics/>
- [5] Microplastics from textiles: towards a circular economy for textiles in Europe, 2023, Available at: <https://www.eea.europa.eu/publications/microplastics-from-textiles-towards-a>
- [6] What happens to our clothes at the end of their lives? , (n.y.), Available at: <https://www.theslowlabel.com/blogs/stories/what-happens-to-our-clothes-at-the-end-of-their-lives>
- [7] Fashion's continued reliance on synthetic materials made from fossil fuels is exacerbating the climate crisis, (n.y.), Available at: <https://www.collectivefashionjustice.org/synthetics>
- [8] What is sustainable fashion and why is it important?, (n.y), Available at: <https://www.linkedin.com/pulse/what-sustainable-fashion-why-important-mirasol-floren-cpa-cma>
- [9] What is Sustainable Fashion? Why Does it Matter and How to Achieve it, (2023), Available at: <https://emeritus.org/blog/sustainability-sustainable-fashion/>





## METHODOLOGY FOR CALCULATING THE REQUIRED VOLUME OF CEMENT FOR CEMENTING THE EXPLOITATION CASING AT WELL B-10

**Milan Marković<sup>1</sup>, Dejan Bajić<sup>1</sup>, Branislava Radišić<sup>1</sup>**

<sup>1</sup>University of Novi Sad, Technical Faculty "Mihajlo Pupin", Zrenjanin, Serbia  
e-mail: [milanzrmarkovic@gmail.com](mailto:milanzrmarkovic@gmail.com)

**Abstract:** This scientific research paper presents a methodology for calculating the necessary volume of cement solution for the efficient cementation of the exploitation column on the B-10 well (fictitious name, due to the confidentiality of the actual data). The study aims to provide an accurate cement volume calculation based on the relevant data of the B-10 well, taking into account the specific characteristics of the well and the need for single-stage cementation. In addition to a detailed budget, the work includes a review of the relevant professional literature on the different types of cementation, with special emphasis on single-stage cementation. Also, the research partly focuses on protective pipes exploring their specific purposes and role to guarantee the successful realization of the envisaged interventions and bring the drill to its destination with the most favorable economic results. The results of this research provide a clear understanding of the process of calculating the required volume of cement for the B-10 drill and at the same time contribute to a wider understanding of single-stage cementation and the role of protective pipes in the oil and gas drilling industry. This methodology has practical applications, and this method of calculation can be applied to other wells.

**Keywords:** cement solution, cementation, exploitation casing, single-step cementation, casing

### INTRODUCTION

In today's world, the oil and gas industry plays a key role in meeting the world's demand for energy. The process of drilling and exploitation of wells is essential for this industry, and one of the key steps is the cementation of protective pipes. Cementation of protective pipes is essential for the stability of the well and provides a guarantee for the successful realization of the envisaged interventions and bringing the well to its target with the most favorable economic results. The precise volume of the cement solution is crucial. Poor choice of volume can cause inefficient cementation and serious risks. This work focuses on the development of a method for calculating the volume of cement for the B-10 drill. In addition, we will analyze types of cementation, especially single-step cementation, and the role of protective pipes. The research aims to contribute to the efficiency of drilling cementation and improve safety in the oil and gas industry. Calculated volume plays a key role in this process, and our methodology will help engineers make informed decisions for better results.

### MATERIAL AND METHODS

#### How did the cementation process come about?

The use of cement in oil wells dates back to 1903 when the Union Oil Company mixed and dumped cement into a well in California to isolate a water zone and then resumed drilling through the set cement after a waiting period of 28 days. Then, the cement was placed in the wellbore using a standard dump bailer system. About seven years later, A.A. Perkins introduced the now common two-plug cementing method in California using cast iron plugs and displacing the cement and top plug with steam pressure. Over the decades, technological advancement, competition between service companies, and more complex wellbores have transformed cementing into a very specialized field that requires optimum design, planning, and preparation as well as the most up-to-date technology and guidelines to obtain the best results [6].

## **The purpose of cementing casing**

Casing cementation is the process of imprinting cement paste into the ringed space between the casing and the borehole channel wall [5, 12].

The main purpose of cementing casing is as follows [2, 8, 12]:

- Separation of individual perforated layers, and prevention of the collision of layered fluids with the ringed space behind the casing. It is of particular importance that the cement ring separates the production layers from the watered layers lying above or below the production layers;
- Prevention of corrosive action of layered fluids on the built-in casing;
- Fixing of the column of casing in the channel of the borehole;
- In the drilling phase preventing the addition of layered fluids to the well, or loss of mud in the drilled layers.

The cement sheaths play an important role in the integrity of a well throughout its life. To guarantee cement sheath integrity one should consider the cement sheath properties, taking into account the effects of well operations, the cement slurry design and testing, the cement slurry placement, and the cement sheath evaluation [1].

## **Types of cementation**

The following types of cementation in oil and gas wells are distinguished [6, 12]:

1. Primary cementation and
2. Cementation under pressure (remonted cementation).

### **Primary cementation**

Primary cementation is the cementation of a built-in series of casing in a borehole along the entire length of the installation, or only in one part, depending on the conditions in the borehole and the purpose of the casing [10, 11, 12].

The primary purpose of primary cementation is [11, 12]:

- isolation of problematic zones (with mud losses, abrasions, or rock mass bubbles) behind the casing to be able to continue drilling deeper formations;
- isolation of the normal pore pressure zone immediately before entering the elevated pore pressure zone;
- the insulation with cement stone of production layers located above or below the production layers;
- the prevention of corrosive action of layered fluids on the built-in casing;
- fastening columns of casing in the channel of the borehole.

Primary cementation can be [12]:

1. Single-step cementation and
2. Two-step cementing

### **Single-step cementation**

Single-step cementation is the raising of the cement slurry to a planned height in the interspace between the casing and the wall of the borehole in one operation, following the sequence of procedures [12]:

- After installing the casing in the borehole, the borehole channel is cleaned by rinsing, i.e. the clay coating is removed from the walls of the borehole by scrapers and centralizers, to achieve better contact with the cement-wall borehole;
- On the cementation head, the first bottom plug is released and a cement slurry is pressed that pushes the plug up to the impact plate on which the plug stops. Then the pressure builds up, piercing the membrane at the tip, and the cement slurry passes through the tip, the impact plate, the casing shoe, and into the interspace;



- On the cementation head, the second upper plug is released, which is pushed up to the first plug with mud or water. The second plug cleans the inside of the casing from the residual cement slurry, and when it settles on the first plug it prevents further imprinting of the mud inside the column. An increase in surface pressure indicates that the second plug has settled on the first, which also marks the end of the primary cementation.

### Construction of the borehole

In the construction of the casing, the primary task is to select a technically correct and purposeful drilling rig, which is a guarantee of the successful realization of the envisaged interventions and bringing the drilling rig to its destination with the most favorable economic results [12].

Installation of casing involves lowering into the borehole channel columns of pipes that have a smaller outer diameter than the borehole diameter. The space between the casing and the walls of the borehole is filled with cement [12].

The casing built into the borehole has several important functions, both during drilling and during the life of the well. In general, the functions of casing are as follows [3, 12]:

- Separation and isolation of different types of formations to minimize problems during drilling or maximize production during exploitation;
- the provision of access to all planned tools and equipment to continue drilling and enable drilling exploration and acquisition operations;
- Provide for the installation of safety devices at the borehole mouth, both during drilling and for testing and production of the borehole;
- Isolate troublesome formations—these can be unstable (sloughing, swelling, or unconsolidated) formations, zones with high or incurable lost circulation, or a depleted pressure zone above the production horizon [4].

The API grade of the casing denotes the steel properties of the casing. The grade has a letter, which designates the grade, and a number, which designates the minimum yield strength in thousands of psi. A table of API casing grades and properties is listed below [3]:

**Table 1.** API quality chart [3]

API Grade	Yield Strength (min), psi	Tensile Strength (min), psi
H-40	40,000	60,000
J-55	55,000	75,000
K-55	55,000	95,000
C-75	75,000	95,000
L-80	80,000	100,000
N-80	80,000	100,000
C-90	90,000	105,000
C-95	95,000	105,000
P-110	110,000	125,000

We distinguish the following types of casing: introductory, surface, technical, lost, and exploited casing [12].

## RESULTS AND DISCUSSION

### Water and Cement Ratio

The optimum water-to-cement ratio for a cement slurry is the result of a balance between opposing trends. On the one hand, low water-to-cement ratios generate dense, high-strength set cements. Tests have suggested that the maximum cement strength is obtained at a water–cement ratio of about 0.25 liters of water per kilogram of cement. This is the minimum amount of water necessary to fully chemically react and hydrate the cement particles. The well design

will normally fix a range for the slurry density. This will be influenced by the height to which the cement is to be lifted, e.g. 150 m inside the previous shoe, and the available pore/fracture pressure window. The slurry density will normally be higher than the mud density [2]. The American Petroleum Institute (API) sets specifications for the following cement classes: As well as the Classes A, B, C, D, E, F, G, and H the API recognizes grades of sulfate resistance: ordinary, moderate sulfate and high sulfate resistance [9, 12].

### Calculation for the required volume of cement solution for single-step cementation

The formula for calculating the volume of the cement solution:

$$V = \left(\frac{R}{2}\right)^2 * \pi * H \quad (1)$$

Where is it:

R – the outer/inner diameter of the protective pipes or the borehole channel diameter [m] and  
H – depth of borehole/deepness of installed casing [m]

Facts about the drill:

- depth of drilling 1250m,
- the top of the cement for the exploitation of the exploitation casing should be 600m,
- An exploratory casing built at 1248m, while its outer diameter is 139.7mm, and the inner 125.7mm,
- casing float shoe (stop plate) installed at 1226m,
- a technical casing built up to 700m and cemented to the top, an outer diameter of 244,5mm, and an inner diameter of 225mm,

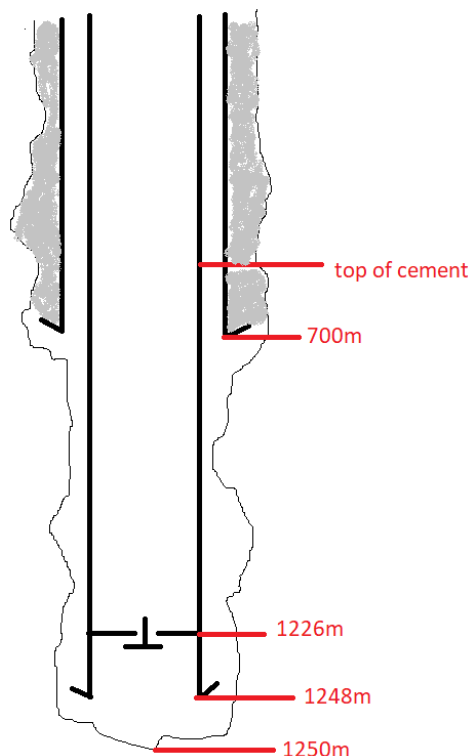


Fig. 1. Figure before cementation

- Calculation of the average bore diameter based on the data obtained by the caliper (values are in inch, so it is necessary to convert the result obtained to mm):

od 1250m – 1100m	11"	→	(1250m-1100m)* 11" = 1650
od 1100m – 1000m	10"	→	(1100m-1000m)*10" = 1000
od 1000m – 900m	8 $\frac{1}{2}$ "	→	(1000m-900m)*8 $\frac{1}{2}$ " = (100*8)+(100* $\frac{1}{2}$ ) = 850
od 900m – 870m	9"	→	(900m-870m)*9" = 270
od 870m – 825m	9 $\frac{1}{2}$ "	→	(870m-825m)* 9 $\frac{1}{2}$ " = (45*9)+(45* $\frac{1}{2}$ ) = 427,5
od 825m – 810m	8 $\frac{1}{2}$ "	→	(825m-810m)* 8 $\frac{1}{2}$ " = (15*8)+(15* $\frac{1}{2}$ ) = 127,5
od 810m – 700m	10"	→	(810m-700m)*10" = 1100

$$\frac{(1650 + 1000 + 850 + 270 + 427,5 + 127,5 + 1100)}{(150 + 100 + 100 + 30 + 45 + 15 + 110)} = \frac{5425}{550} = 9,86''$$

$$9,86'' * 25,4mm = 250,44mm \quad \rightarrow \quad 1'' = 25,4mm$$

The first step is to calculate the necessary volume of cement, to perform the cementation from the place where the casing float shoe (stop plate) is placed to the bottom:

R<sub>1</sub> – an internal diameter of the operating casing of 125,7 mm (converted to m), and  
 H<sub>1</sub> – height = 1250m-1226m = 24m

$$V_1 = \left(\frac{R_1}{2}\right)^2 * \pi * H_1$$

$$V_1 = \left(\frac{125,7 * 10^{-3}m}{2}\right)^2 * 3,14 * 24m = 0,3m^3 = 0,3 * 10^3 dm^3 = 300l$$

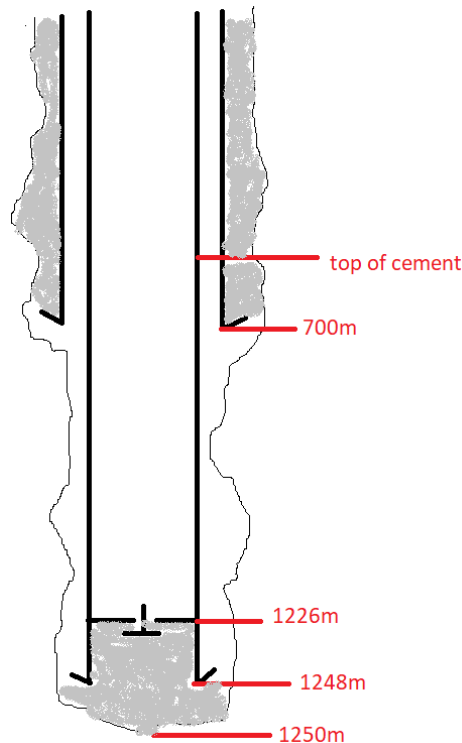


Fig. 2. Cemented from the stop plate to the bottom

The second step is to calculate the necessary volume of cement, to perform the cementation from the bottom to the height of the installed technical casing:

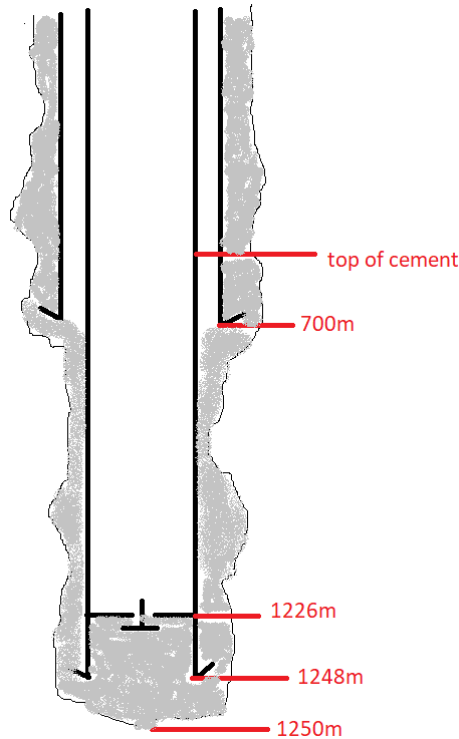
R<sub>2</sub> – an external diameter of the operating casing of 139,7 mm (converted to m),

$R_3$  – mean diameter of the borehole 250.44mm (converted to m),  
 $H_2$  – height = 1250m-700m = 550m

$$V_2 = \left( \left( \frac{R_3}{2} \right)^2 - \left( \frac{R_2}{2} \right)^2 \right) * \pi * H_2$$

$$V_2 = \left( \left( \frac{250,44 * 10^{-3}m}{2} \right)^2 - \left( \frac{139,7 * 10^{-3}m}{2} \right)^2 \right) * 3,14 * 550m = 18,653m^3$$

$$= 18.653 * 10^3 dm^3 = 18653l$$



**Fig. 3.** Cemented from the bottom to the height of the installed technical casing

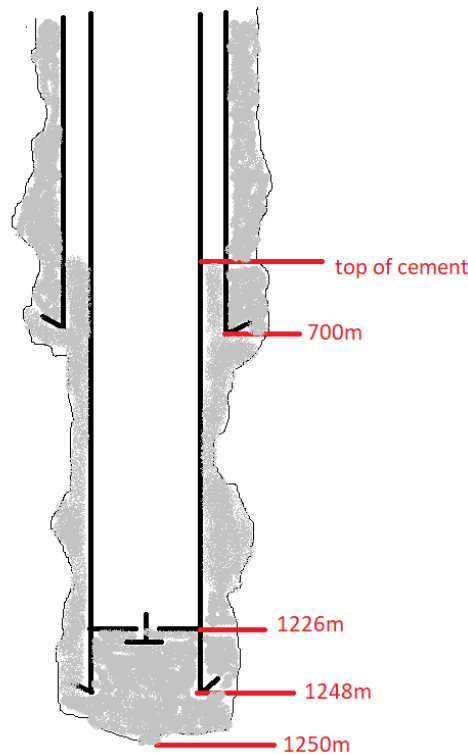
The third step is to calculate the necessary volume of cement, to perform a cementation of 700m – 600m (overlap of technical and operational casing):

$R_4$  –internal diameter of the technical casing of 225 mm (converted to m),  
 $R_5$  – the outer diameter of the exploitation column is 139,7 mm (converted to m),  
 $H_3$  – height = 700m-600m = 100m

$$V_3 = \left( \left( \frac{R_4}{2} \right)^2 - \left( \frac{R_5}{2} \right)^2 \right) * \pi * H_3$$

$$V_3 = \left( \left( \frac{225 * 10^{-3}m}{2} \right)^2 - \left( \frac{139,7 * 10^{-3}m}{2} \right)^2 \right) * 3,14 * 100m = 2,442m^3 = 2,442 * 10^3 dm^3$$

$$= 2442l$$



**Fig. 4.** Cemented through technical and operational columns at a height of 100 m

Finally, the total volume of cement should be calculated:

$$V_{ukupno} = V_1 + V_2 + V_3 = 300l + 18653l + 2442l = 21395l$$

### Cement Bond Log – CBL

The cementation's quality is measured after drilling and is part of the drilling completion program. Such measurements are made by acoustic method and they provide data on the bonding of cement linings, casing columns, formations, and cement linings. It is very important to determine the quality of the cementation performed, as this can prevent problems that may arise in the longer life of the well. It should be noted that poorly executed cementation can lead to water pollution in shallow layers. Digital CBL is an ultrasonic probe simulator for measuring the quality of cement cladding in cemented boreholes. The digital CBL is designed to enable the simulation of cement coating quality measurements in rotation measurements.

### CONCLUSION

This scientific research work presents a methodology for calculating the required volume of cement solution for the efficient cementation of the exploitation casing on the B-10 well. The research aimed to provide an accurate cement volume calculation based on the relevant data of the B-10 well, taking into account the specific characteristics of the well and the need for single-step cementation. The work also included a review of the relevant professional literature on different types of cementation, with special emphasis on single-step cementation. The research also focused on the casing and its role in guaranteeing the successful realization of the envisaged interventions and the economic efficiency of the drilling. The calculations are detailed for the different segments of the drill hole cementation, including cementation from the place of placing the casing float shoe to the bottom, from the bottom to the height of the installed technical casing, and overlapping of the technical and operational casing. The total volume of cement is calculated based on these segments.

This methodology has practical applications and can be applied to other wells. Cementation quality is essential for the safety and longevity of the well, and this research provides tools for

engineers to make informed decisions and improve the process of well cementation in the oil and gas industry. The paper also mentions measuring the quality of the cement cladding, which is key to preventing future problems and preserving the integrity of the borehole. The digital CBL (Cement Bond Log) is an important tool for such measurements. In conclusion, this work provides a deep understanding of the process of calculating the required cement volume for the B-10 well and at the same time contributes to a wider understanding of cementation and the role of casing in the oil and gas industry.

## REFERENCES

- [1] J.L. De Paula, V.F. Rodrigues, and R. Vicente, Cement Sheath Evaluation in Nonconventional Environment—Case History, *Petróleo Brasileiro*, This paper was prepared for presentation at the 2007 SPE Annual Technical Conference and Exhibition held in Anaheim, California, U.S.A., 11–14 November 2007, p. 1, Anaheim, 2007
- [2] Leković Branko<sup>1</sup>, Karović-Maričić Vesna<sup>1</sup>, Danilović Dušan<sup>1</sup>, CASING CEMENTING IN DIFFICULT GEOLOGICAL CONDITIONS, UNDERGROUND MINING ENGINEERING 27 (2015) 65-74, UNIVERSITY OF BELGRADE - FACULTY OF MINING AND GEOLOGY, p. 66, Belgrade, 2015
- [3] Baker Hughes INTEQ, Drilling Engineering Workbook, A Distributed Learning Course, Baker Hughes INTEQ Training & Development 2520 W.W. Thorne Houston, TX 77073 United States of America 713-625-4415, pp. 90-94, Houston, 1995
- [4] John Finger and Doug Blankenship, Handbook of Best Practices for Geothermal Drilling, SANDIA REPORT SAND2010-6048 Unlimited Release Printed December 2010, pp. 27-29, Albuquerque and Livermore, 2010
- [5] Letvenčuk, Ivona, PRIPREMA I IZVOĐENJE CEMENTACIJE ZAŠTITNIH CIJEVI, Undergraduate thesis / Završni rad, University of Zagreb, Faculty of Mining, Geology and Petroleum Engineering / Sveučilište u Zagrebu, Rudarsko-geološko-naftni fakultet, p. 1, Zagreb, 2022
- [6] ALEXANDER ANYA, AN OVERVIEW OF PRIMARY CEMENTING IN OIL AND GAS WELLS, SUPERVISING FACULTY: DR. MARSHALL WATSON, pp. 2-3, 2015
- [7] Bojan Dakić, Dragan Stupar, Miodrag Brkić, Miloš Živanov, Laboratorijski prototip: Simulator sonde za merenje kvaliteta cementne obloge u zacevljenim bušotinama – digitalni CBL, U okviru projekta III43008, pp 1-2, 2012
- [8] JOURNAL OF PETROLEUM TECHNOLOGY(JPT), Subsea Technology/Cementing Operations, CEMENTING IN AREAS PRONE TO SHALLOW SALTWATER FLOWS, p. 840, 1997
- [9] The ChevronTexaco and BP Cement Manual, Proprietary - for the exclusive use of BP & ChevronTexaco, Cement Manual, pp. 62 and 151, 2002
- [10] Erik B. Nelson and Dominique Guillot, Well Cementing Second Edition, Schlumberger 225 Schlumberger Drive Sugar Land, Texas 77478 www.slb.com, pp. 1-2, Texas, 2006
- [11] Erik B. Nelson, Well Cementing, Schlumberger Educational Services 300 Schlumberger Drive Sugar Land, Texas 77478, p. 298, Texas, 1990
- [12] Dr Renato Bizjak, TEHNOLOGIJA BUŠENJA SA PROJEKTOVANJEM, NIS NAFTAGAS Novi Sad, pp. 139-141, 231-233, 244 Novi Sad, 2004



## **AUTOMATED DECISION SUPPORT SYSTEMS USING ARTIFICIAL INTELLIGENCE IN QUALITY ENGINEERING WITHIN THE AUTOMOTIVE INDUSTRY**

**Sondra Preascilla Ioana Văcărescu<sup>1,2</sup>, Nicolae Paraschiv<sup>1</sup>, Valentina Emilia Balas<sup>3,1,4</sup>**

<sup>1</sup>Petroleum-Gas University of Ploiesti, Romania

<sup>2</sup>Continental Automotive Romania

<sup>3</sup>Aurel Vlaicu University of Arad, Romania

<sup>4</sup>Romanian Academy of Scientist

e-mail: [priscilla.vacarescu@yahoo.com](mailto:priscilla.vacarescu@yahoo.com)

**Abstract:** Data is vital in business, with positive impact in: the improvement of customer relationships (increased customer satisfaction), sales increase, for the development of new products. The constraint is that data analysis can take up to several hours daily, consuming valuable from employee; time that could be spent tackling other tasks.

The purpose of any Automated Decision Support System is to provide the necessary IT support to mitigate the effects of the limits and restrictions (cognitive, communication, time, etc.) faced by the human decision-maker during the activities they carry out to solve those decision problems that they are characterized by importance and complexity.

In this paper we propose to solve a specific problem from the automotive industry.

**Key words:** data management, data analysis, artificial intelligence.

### **INTRODUCTION**

A group of authors stated that the automated decision support system with the aid of the artificial intelligence (deep learning algorithms, neural network) eliminates the occurrence of errors, wrong interpretation of the data with final impact on the company key performance indicators or customer satisfaction [1-9]. The purpose of this paper is to identify all the influential factors, risks that might occur if the analysis would be performed by operators, and use artificial intelligence instead (neural network, deep learning algorithms) to have a fast problem solving, obtain an accurate prognosis, to define preventive actions for the increase of the customers satisfaction. In the second chapter of the paper, the determination of the possible causes via Ishikawa diagram [10] was used, the third part describes the results and discussions for the system automation. At the end of the paper we present the conclusions. Reports by Gartner and Deloitte identify it as technology trend and highlight the benefits that can be achieved when artificial intelligence is combined with data management. According to Gartner, the automation and machine learning can reduce the manual data management tasks up to 45%.

### **MATERIAL AND METHODS**

Currently, in the automotive industry, the analysis of the data related to cost of non conformance or customer incidents is performed in an internal data base using pre-defined formulas able to generate graphics, charts, etc.

For the consecutive analysis of all aspects of decision-making, the classification given by H. Simon and A. Newell will be used, which can elucidate the situation for our purposes [3].



- Well-structured and quantitatively formulated problems, in which essential dependencies are highlighted as well as they can be expressed by numbers and symbols, which ultimately get numerical evaluations.
- Unstructured problems or qualitatively expressed problems, which they contain only the description of the most important resources, features and properties, the quantitative dependencies between which are absolute unknown.
- Weakly structured problems are those problems, which contain both quantitative and qualitative elements and qualitative moments prevails.

A. Newell believes that the problem is well structured by measuring the satisfaction by following criteria [3]:

- can be described in terms of variables (scaling or vectors), which have numerical values; objectives can be defined with the help of objective functions
- clear and well-defined (eg maximizing income or minimizing expenses); there are algorithms for obtaining the numerical solution.

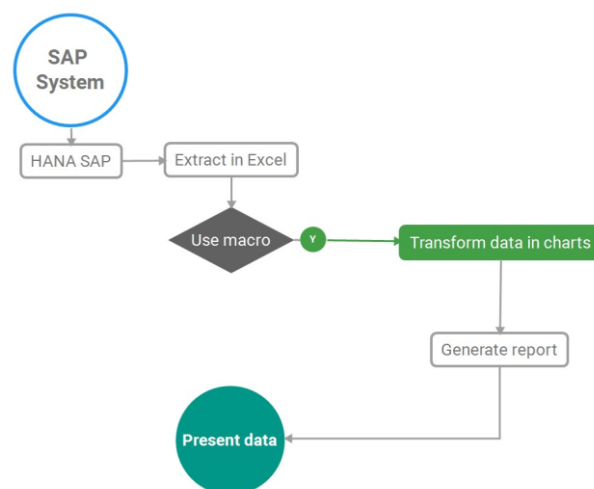
Practically, the data are included in external databases, therefore several steps that have to be taken for a complete analysis. Automated decision making in the given architecture is not possible, due to restriction within the intellectual property or cyber security. Therefore data exports have to be performed, as described below, in the automotive industry for the component suppliers.

For customer incidents, the technical data related to the defect product is included in the customers data base. In order to maintain a one to one view with the customer data base, each supplier of components, has to introduce the customer data in the internal system.

The most utilized system in the industry is Systeme Anwendungen und Produkte (SAP). The data are exported in HochleistungAnalyseAnwendung (HANA) system, which allows a data visualization as [12]:

- Trend of incidents on a selected time scale
- Parts per million
- Source of defect

For more complex analysis the data has to be extracted, and analyzed offline of the Systeme Anwendungen und Produkte (SAP) system, as presented in the Fig. 1.



**Fig.1** Structure of the extraction from the SAP system

The risks that might occur by the data analysis of an operator are included in the Ishikawa diagram [10] presented in Fig.2.

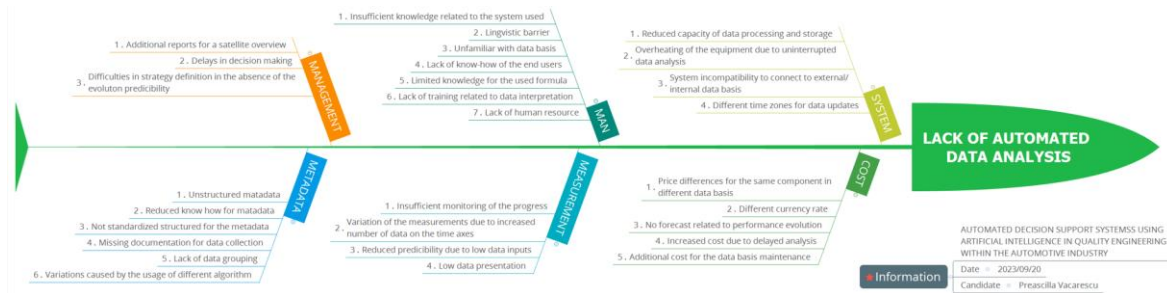


Fig.2 Ishikawa diagram

In case of several field incidents with the same behaviour or same type of defect, incidents that appear at the end user (in field – according to industrial naming), the data as customer incident date, production date of the vehicle, vehicle identification number, etc., have to be extracted and statistical prognosis calculated. One possibility is to perform a Weibull analysis with data extracted from data base, Fig.3 and technical data presented in Table 1 and Table 2 in excel files (as for this case study):

Fig. 3 Data base

Table 1. Tehnical data

VIN	Vehicle Production Date	Registration date	Repair date	MIS	TIS	Mileage in km	m/month
V2CXMBN234	11.10.22	20.09.22	20.10.22	30	0.98	110	110
ZBSJHEEA232	21.10.22	02.11.22	04.11.22	2	0.07	12	223
FCJAFSVF134	19.08.22	25.08.22	03.09.22	8	0.26	40	381

VIN=vehicle identification number; TIS=time in service; MIS= months in service

Table 2. Potential affected volumes

Month/Year	Produced	Sold
22-Aug	25678	25342
22-Sep	25678	25342
22-Oct	25678	25342
22-Nov	25678	25342
22-Dec	25678	25342

The Weibull analysis prognosis presents the prognos of the potential returned parts during the warranty period of time forthe vehicle, as shown in the Fig. 4 below.

Right censored data respected by method of Johnson (survivors according mileage distribution estimated) [14]:

- Maximum likelihood (MLE) 2-parameters Weibull distribution fit;
- The slope, b is aproximately 0,27 is pointing to an early failure behavior;

- Assumption of prognosis is that 100% failed parts have been returned by the customer.

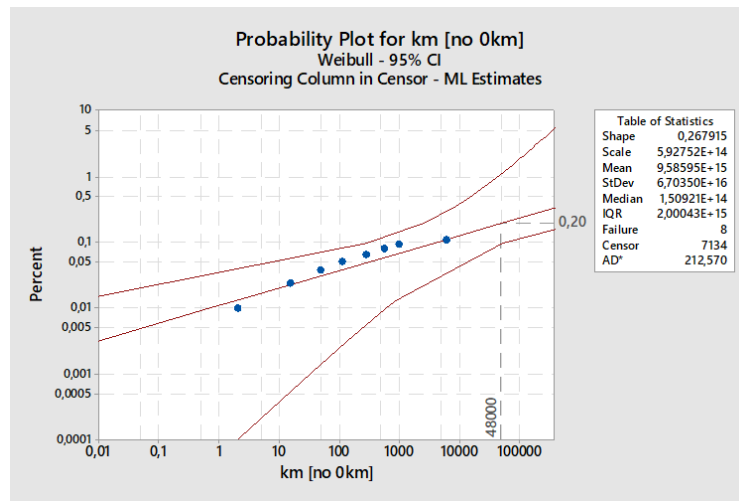


Fig. 4. Weibull prognosis

Table 3 presents the prediction related to the potential returned products within the warranty period. In the formula used for the prognosis calculation, it was taken into consideration that one vehicle has a distance range of 2000 km/month. The calculation within Table 3 estimates that in the first year, the range of the distance for one vehicle will be 24000 km, so that 172 parts might be affected by the defect. This would mean 1641 parts per million. The prognosis also shows us that the defect rate will in the second year will be 209 possible returned parts and 231 pieces in the third year. The evolution presented below revealed that the defect will manifest in the first year of the vehicle's lifetime, while in the next two years the potential return rate will decrease. Usually, the warranty return period in the automotive industry is three years of the vehicles' lifetime. Therefore, all the prognoses are calculated within this period.

Table 3. Results of prognosis

x(km)	H(t) - 2pW	2000km/month	calculated parts
24000	1641	12	172
48000	1975	24	207
72000	2201	35	231

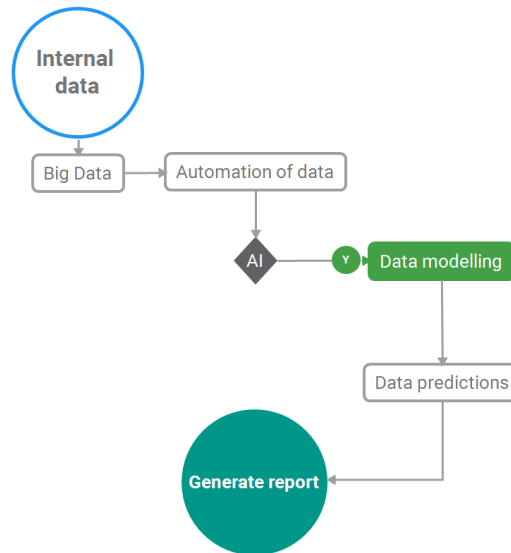
## RESULTS AND DISCUSSIONS

The above presented workflow is showing that the big majority of the data from customers within the automotive industry are stored in customer portals. These include: product name, description, date of production, failure date, mileage, technical behavior, defect quantity. As above mentioned, up to 90% of the data have to be included in the suppliers data base, to create one to one view (for commercial reasons). The HochleistungAnalyseAnwendung (HANA) system used by many companies within the automotive industry is capable to present charts, evolution trend, etc. In many areas of the automotive industry for prognosis as Weibull analysis, the data can be exported in an excel file. Afterwards, the customer data as vehicle identification number, months in service, time in service is corellated with product behavior have to be taken into consideration for the prognosis calculation in tools as Minitab. For the Weibull calculation the data from customer portal transferred to the suppliers internal system is not sufficient; the delivered quantity per month is also essential. Cases might occur when the same defect might appear on other similar platforms, and the classical calculation cannot predict or foreseen the risk in correaltion with other technical inputs.

Having in view that only for one prognosis, two data bases are used, and at least three excel files and one Minitab tool, not to mention the days invested in these analysis, and the

experience of the operator, we can conclude that an automated decision making system using artificial intelligence (AI), machine learning (ML) using artificial neural network (ANN) would be the best option.

In order to reduce the non-productive time spent with the manual analysis of the data, to eliminate the human errors, the automation of the decision-making data analysis is vital and the future process flow is described as in Fig. 5.



**Fig. 5.** Automated decision using AI

## CONCLUSION

The scope of this paper is to automate the data analysis from customer portal in correlation with the internal data system. In this way, patterns related to defect appearance, source of defect, equipment / process weaknesses can be easily observed. Moreover, AI using ANN and machine learning, can make predictions in order to define the preventive actions to eliminate any negative impact on the business. Nevertheless, the prediction related to the appearance of one defect, can be extrapolated on other products, with the same hardware layout, software or same functionality (same product platforms, customer carlines). On a bigger scale, the prognosis could be applied also in other company locations with similar technological infrastructure.

In the future we would like to develop an automated decision support system to improve the actual process within the automotive industry.

Robust strategies can be applied on management level to enhance the business profitability. Nevertheless, the human resources can be developed in different areas to add value to the business.

## REFERENCE

- [1] Balas, V.E. – "Teoria Sistemelor", Editura Universității Aurel Vlaicu Arad, 2013.
- [2] Balas, V.E., Hemachandran K, Rodriguez R.V., Subramaniam U. – "Artificial Intelligence and Knowledge Processing", CRC Press 2023.
- [3] F.G.Filip "Sisteme suport pentru decizii" Editura tehnică, București, 2007
- [4] Balas, V. E, Semwal, V. B. , Khandare, A. , Patil, M. – "Intelligent Computing and Networking", Springer 2021.
- [5] Gaidric, C., "Luarea deciziilor. Metode și tehnologii", Știința, Chișinău, 1998.
- [6] Paraschiv, N.– "Programarea aplicațiilor de timp real". Sionteze Editura Universitatii Petrol – Gaze, din Ploiești, 2018

- [7] Paraschiv, N. – "Achiziția și prelucrarea datelor", Editura Universității Petrol – Gaze din Ploiești, 2013.
- [8] Balas, V.E., Solanki V.K. , Raghevendra, Kumat R. – "Recent Advances in Internet of Things and Machine Learning. Real-World Applications", Intelligent Systems Reference Library 2015, Springer 2022.
- [9] Balas, V. E, Semwal V. B. , Khandare A. , Patil M. – "Intelligent Computing and Networking", Springer 2021.
- [10] Ishikawa, Kaoru, (Translator: J. H. Loftus);" Introduction to Quality Control"; 448 p, 1990. ISBN 4-906224-61-X OCLC 61341428
- [11] [Artificial Intelligence and Knowledge Processing: Improved Decision-Making and Prediction](#)
- [12] <https://www.sap.com/products/technology-platform/hana.html>
- [13] <https://www.integrate.io/glossary/automate-data-management-processes/>
- [14] <https://www.itl.nist.gov/div898/handbook/eda/section3/eda3668.htm>



## THE STUDY OF WATER PARAMETERS IN AN AQUAPONIC SYSTEM

**Daniel Alexuță<sup>1,2</sup>, Marius M. Bălaș<sup>1,2</sup>**

<sup>1</sup>Petroleum-Gas University of Ploiesti, Romania

<sup>2</sup>Aurel Vlaicu University of Arad, Romania

e-mail: [alexutadaniel@yahoo.com](mailto:alexutadaniel@yahoo.com)

**Abstract:** This article highlights the key parameters encountered in aquaponic systems that can assess water quality. By implementing such systems, the Sustainable Development Goals set by the United Nations in 2015 can be achieved, contributing to new opportunities for various research fields that may be opened. Furthermore, by adopting these cultivation methods, product quality and freshness can be improved. A small-scale installation has been created to allow data collection, and there are plans for its future automation using an Arduino board. By implementing fuzzy logic and utilizing the collected data, the aim is to model water quality, addressing the challenges that arise when implementing such a system.

**Key words:** aquaponics, water parameters, monitoring parameters

### INTRODUCTION

Aquaponic systems have a lower impact on the ecosystem because they have self-regulating capacity, and there is no need for the use of pesticides, herbicides, or fertilizers, as the system does not require them. According to a study [1], 70% of the globally consumed water in food production could be saved with up to 30-70% if efficient irrigation systems were used and up to 90% if aquaponic systems were used. Over the past 200 years, freshwater fish have contributed more to food security than any other form of aquaculture production [2]. Several Sustainable Development Goals (SDGs) have been highlighted for the study of aquaponics, citing five principles from the sustainable development goals established by the United Nations in 2015:

- SDG2: Zero Hunger;
- SDG7: Clean Energy for All;
- SDG8: Decent Work and Economic Growth;
- SDG12: Responsible Consumption and Production;
- SDG14: Life Below Water, Protecting Marine Life [3].

The most important water parameters are introduced as follows: pH, temperature, dissolved oxygen (DO), electrical conductivity (EC), salinity, and water alkalinity.

The ideal pH for the hydroponic component is close to 6.0. Roots may be damaged at pH values below 4.5, which can create nutritional deficits in plants [4]. Aquatic systems are typically sensitive to pH variations in the water. The pH range needed for the nitrification process is between 7.0 and 9.0, with enhanced efficiency noted in the range of 8.4 to 8.8 [5]. Since they act as nutritional buffers, bases like potassium and calcium should be given priority for adjusting pH in the aquatic system [5, 4]. Fish health can be dramatically impacted by small alterations (0.3) over a short time (18–24 hours) [4].

Most other water-related characteristics in the aquatic system are correlated with water temperature. The ideal temperature for the nitrification process is between 17 and 34 °C [4]. The nitrification process will not be successful if the water temperature is below this range, because the productivity of the bacteria decreases. The ideal temperature range for the hydroponic component is 18–30 °C [4]. The danger of disease is decreased when fish are kept at the proper temperature. The ideal temperature is from 22 to 32 degrees Celsius for tropical fish, whereas 10 to 18 degrees Celsius is needed for cold-water fish species. The

ideal temperature range for other species is 5 to 30 °C [4]. Increased water temperatures can limit plants' ability to absorb calcium.

The three creatures that coexist in the aquatic environment—fish, bacteria, and plants—depend on the amount of DO in the water. Sustaining aquatic life depends a lot on the volume of water but also parameters such as dissolved oxygen, pH, temperature and others that can influence these parameters [6]. The parameter with the most rapid and significant effects on aquaponics has been reported to be oxygen, which is dissolved in water in extremely small concentrations (parts per million, or ppm). In natural settings, green plants and aquatic algae use photosynthesis to create oxygen. Any aquaponic system must be monitored since the dissolved oxygen levels can change significantly over only 24 hours. Because warmer water may store less oxygen, temperature and DO are closely related. Fish consume more DO while they eat, and in some situations, additional DO may be required. The presence or absence of dissolved oxygen in the water influences the nitrification process because it is an oxidizing process, the lack of this element in the water can significantly affect this process. Low oxygen levels make microorganisms less able to break down ammonia and nitrites, potentially raising threats to the health of fish and plants. The range of 4 to 8 mg/l is ideal for nitrifying bacteria. During respiration, plants take in oxygen through their leaves, but they must also take in oxygen through their roots. Plants in the hydroponic component require high DO concentrations, usually >3 mg/l [4].

In the case of aquaponic systems, electrical conductivity (EC), a measure of a medium's capacity to conduct electric current, is closely related to salinity [7]. As a result, the fish population is most vulnerable to EC changes. Low levels may be an indication of unbalanced systems because it is also related to how fresh the water is [7]. High EC levels are a sign of contaminated water and can kill off fish populations. However, to aid fish in maintaining osmotic equilibrium, a low salt concentration is preferred. The average range for fish is between 100 and 2000 mille Siemens per centimeter (mS/cm), however a greater range (30 to 5000 mS/cm) is acceptable [8]. The amount of positively charged calcium and magnesium salts present in the water solution is measured as water hardness. Low water hardness levels just stress fish, however excessive levels can be fatal because they raise the pH of the water, which reduces nitrification rates and plant nutrient uptake. Between 50 and 150 mg/l is the ideal range for water hardness, but most species can tolerate >10 mg/l [8]. TDS or EC measurements can be used to determine the quality of the water [9].

Salinity is a measure of the quantity of salt in the water [7] and has an impact on fish density and growth [10]. Similar to TDS, salinity is frequently determined by measuring electrical conductivity. Various fish species require different salinity ranges. For common carp, the most popular adoption was made by Garg and Bhatnagar in 1996, and it ranges from 0 to 2 ppt (parts per trillion) [11].

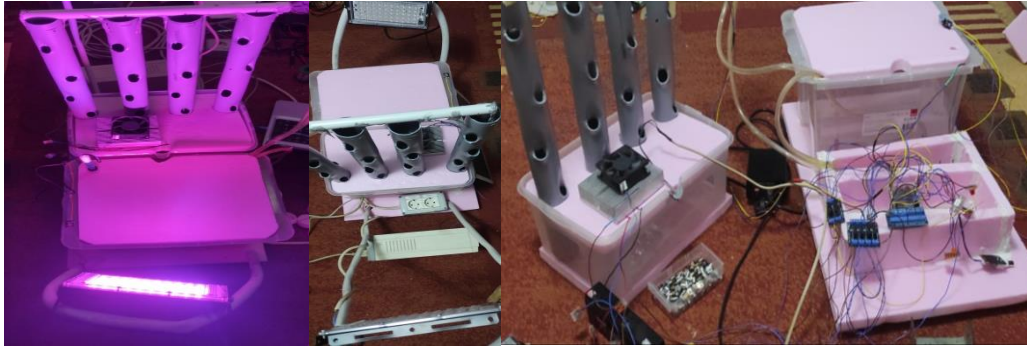
The concentration of bases, carbonate and bicarbonate in aquatic systems, is measured by the alkalinity of the water. Alkalinity measures negative ions, whereas hardness measures positive ions, which is why hardness and water alkalinity. Alkalinity is typically described as the water's power to neutralize acids or its resistance to pH fluctuations. Low concentrations suggest that even trace amounts of acids can result in considerable pH alterations [11], and high alkalinity concentrations can convert non-hazardous ammonia into toxic ammonia. The range of acceptable alkalinity is 50 to 150 mg/l CaCO<sub>3</sub> [8].

## **MATERIAL AND METHODS**

As the complexity of the aquaponic system increases, monitoring and control become necessary. Monitoring and controlling water quality will be accomplished by implementing intelligent driving and prediction algorithms.

Figure 1 depicts a small-scale aquaponic installation through which we aim to monitor and control such a system. Currently, it is in the prototype stage, and we have collected some data. However, since it is not fully operational yet, it is still in the development phase.





**Fig. 1.** Aquaponic Installation

The small-scale installation has been set up to enable data collection for water quality monitoring, and simultaneously, attempts have been made to automate this installation using Arduino development boards. Currently, the automation project is in progress, and data has been collected using sensors and devised presented in Figures 2 and 3.



**Fig. 2.** pH-W218 Device, Monitoring Temperature, pH, ORP, TDS, and more.



**Fig. 3.** BLE-9100 Device, Monitoring Dissolved Oxygen.

Figure 4 presents the aquaculture system and the pH-w218 device that allows data collection in the cloud, while Figure 5 shows an interface enabling the visualization of collected data on a smartphone through an IoT (Internet of Things) connection. Figure 6 displays the smartphone application, which, via Bluetooth, collects data about dissolved oxygen from the aquaculture system.



**Fig. 4.** Monitoring the water quality parameters in the aquaculture system.



**Fig. 5.** Monitoring water quality parameters in the aquaculture system on a smartphone.



**Fig. 6.** Monitoring the dissolved oxygen level in the aquaculture system on a smartphone.

## RESULTS AND DISCUSSION

Understanding aspects related to water quality is very important for successful management leading to good fish production. A falling or rising of water quality parameters beyond the optimum values will have adverse effects. Maintaining a good water quality is an essential activity.

In Table 1, the data collected from the pH-W218 device over a 12-day period on a small-scale system presented in Figure 3.1 are presented. Similarly, in Table 2, data collected from the same fishery system but for the dissolved oxygen parameter are presented.

These data will be compared with the optimal values discussed in the specialized literature, and in the future, through this installation and with the help of these data collection devices, we will attempt to create control and prediction algorithms and try to validate them using these installations.

**Table 1.** Data Collected from the pH-W218 Device

Date	Temperature (°C)	TDS (ppm)	Proportion (S.G)	Salinity (ppm)	pH (0-14)	ORP (mV)	EC (us/cm)	CF (CF)
2023-08-19	25.5	458	0.997	534	8.49	267	916	9.16
2023-08-20	26.2	460	0.997	536	8.54	275	920	9.20
2023-08-21	26.5	455	0.997	531	8.62	283	911	9.11
2023-08-22	26.7	445	0.997	519	8.58	308	890	8.90
2023-08-23	26.7	443	0.997	516	8.47	338	885	8.85
2023-08-24	27.0	443	0.997	516	8.51	366	886	8.86
2023-08-25	26.5	433	0.997	505	8.45	384	867	8.67
2023-08-26	27.1	436	0.997	508	8.50	389	872	8.72
2023-08-27	27.0	428	0.996	499	8.48	383	856	8.56
2023-08-28	27.0	430	0.996	501	8.62	383	859	8.59
2023-08-29	27.0	446	0.996	520	8.74	376	892	8.92
2023-08-30	25.9	451	0.996	526	8.72	382	903	9.03
2023-08-31	24.7	484	0.996	565	8.93	367	968	9.68

**Table 2.** Data Collected from the BLE-9100 Device

Date_Time	DO(mg/L)	DO(%)	Temperature (°C)
2023-09-13 09:25:38	3.96	47.8	24.2
2023-09-13 09:24:38	3.99	47.9	24.2
2023-09-13 09:23:38	3.84	46.0	24.2
2023-09-13 09:22:38	3.70	44.5	24.2
2023-09-13 09:21:38	3.89	46.2	24.2
2023-09-13 09:20:38	3.78	45.1	24.2
2023-09-13 00:04:24	6.29	75.9	24.3
2023-09-13 00:02:42	5.48	65.9	24.5
2023-09-13 00:01:42	5.52	65.9	24.5
2023-09-13 00:00:42	5.48	65.8	24.5
2023-01-03 18:21:17	4.28	47.7	20.8
2023-01-03 18:20:47	4.30	47.9	20.6
2023-01-03 18:20:17	2.99	33.5	20.7
2023-01-03 18:19:47	3.03	33.9	21.2
2023-01-03 18:19:07	3.85	43.4	21.4
2023-01-03 18:18:37	4.05	45.8	21.7
2023-01-03 18:18:07	5.47	61.3	22.2
2023-01-03 18:17:37	8.48	100.6	24.0
2023-01-03 18:17:05	9.83	116.5	23.9

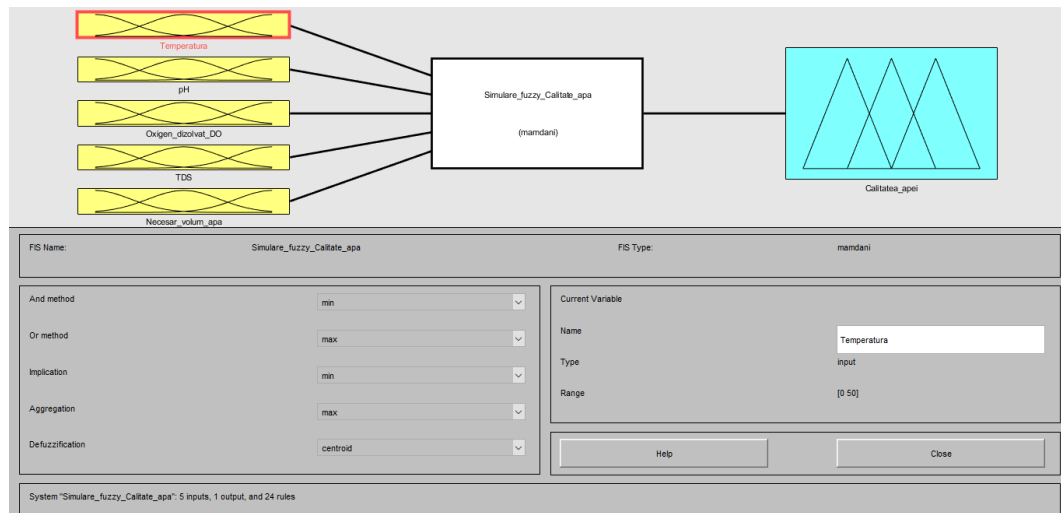
These data were collected from a tank with a volume of 11 liters, housing 10 fish of the crab species, each with a weight ranging between 0.5 to 2 grams.

An interesting tool based on fuzzy logic was developed using natural language for water quality classification. We designed a fuzzy logic system due to uncertainties and nonlinear nature of the water medium in aquaponics. The farmers can evaluate the water quality using the model we developed and to maintain the water quality within acceptable limits.

To assess and manage water quality in aquaponic systems, a fuzzy logic model was developed. This model considers the linguistic variables associated with each parameter, including Very Low (VL), Low (L), Medium (M), High (H), and Very High (VH).

The output of the fuzzy classification model depends on the choice of fuzzy sets, enabling flexible and adaptable monitoring of water quality.

Figure 7 shows the main window of the fuzzy inference system in the Matlab Fuzzy Toolbox for water quality monitoring.



**Fig. 7.** Main window of the fuzzy inference system for water quality

## CONCLUSION

An aquaponic system has been constructed on a small scale to facilitate data collection, and a fuzzy logic model has been proposed to model water quality within the aquaponic system. Aquaponic systems have the potential to address global food security challenges while promoting sustainability and responsible resource use. Monitoring and maintaining optimal water quality parameters are critical for successful aquaponics. The fuzzy logic model presented in this study offers a flexible and adaptable approach to water quality assessment, contributing to the advancement of aquaponic research and practice. Embracing these cultivation methods not only enhances food production but also supports the achievement of key Sustainable Development Goals, ensuring a more sustainable and food-secure future for all.

## REFERENCES

- [1] Simke, A., Aquaponics Presents a New Way to Grow Sustainable Fish and Veggies., 2020
- [2] Naylor, R.L., Hardy, R.W., Buschmann, A.H., Bush, S.R., Cao, L., Klinger, D.H., Little, D.C., Lubchenco, J., Shumway, S.E., Troell, M. A., Retrospective Review of Global Aquaculture 2021, 591, 551–563, 2020.
- [3] FAO., The State of World Fisheries and Aquaculture: Sustainability in Action, 1st ed.; The State of World Fisheries and Aquaculture (SOFIA); Food and Agriculture Organization of the United Nations (FAO): Rome, Italy; ISBN 978-92-5-132692-3, 2020.
- [4] Somerville, C., Cohen, M., Pantanella, E., Stankus, A., Lovatelli, A., Small-scale

- aquaponic food production. Integrated Fish and Plant Farming. FAO Fisheries and Aquaculture Technical Paper No.589, 2014.
- [5] Rakocy, J.E., Aquaponics-integrating fish and plant culture. In: Aquaculture Production Systems. Wiley-Blackwell, Oxford, UK, pp. 344e386, 2012. <https://doi.org/10.1002/9781118250105.ch14>.
- [6] Sallenave, R., Understanding Water Quality Parameters to Better Manage Your Pond. College of Agricultural, Consumer and Environmental Sciences. New Mexico State University Guide W-10, p. 4, 2012.
- [7] Nagayo, A.M., Mendoza, C., Vega, E., Izki, R.K.S. Al, Jamisola, R.S., An automated solar-powered aquaponics system towards agricultural sustainability in the Sultanate of Oman. In: 2017 IEEE International Conference on Smart Grid and Smart Cities (ICSGSC). IEEE, pp.42e49, 2017. <https://doi.org/10.1109/ICSGSC.2017.8038547>.
- [8] Stone, N.M., Thomforde, H.K., Understanding Your Fish Pond Water Analysis Report, Cooperative Extension Program. University of Arkansas at Pine Bluff, Pine Bluff, 2004.
- [9] Brand, G.W.A.X., Can you determine water hardness from conductivity or total dissolved solids measurements, 2011. <http://www.globalw.com/support/hardness.html>.
- [10] Bhatnagar, A., Devi, P., Water quality guidelines for the management of pond fish culture. Int. J. Environ. Sci. 3, 1980e2009, 2013. <https://doi.org/10.6088/ijes.2013030600019>.
- [11] Garg, S.K., Bhatnagar, A., Effect of varying closes of organic and inorganic fertilizers on plankton production and fish biomass in brackish water fish ponds. Aqua-cult. Res. 27, 157e166, 1996. <https://doi.org/10.1111/j.1365-2109.1996.tb0098.x>.





## AUTOMATED SYSTEMS IN SMART AGRICULTURE

**Marius Susa<sup>1</sup>, Nicolae Paraschiv<sup>1</sup>**

<sup>1</sup>Petroleum-Gas University of Ploiesti, Romania

e-mail: [susa.marius96@gmail.com](mailto:susa.marius96@gmail.com)

**Abstract:** Based on the reasoning presented by experts that artificial intelligence is a scientifically crucial tool to address current global problems and agriculture in particular, in this article, I will try to highlight the importance and role of artificial intelligence and especially Unmanned Aerial Vehicles (UAVs), whose rapid integration into practice will provide the results that Precision Agriculture needs, because Unmanned Aerial Vehicles are indispensable equipment for a modern agricultural operation.

Drones are used to give farmers a panoramic view of their crops. This allows them to detect problems such as pests, weeds, and diseases at an early stage. This allows for early intervention, which can save time and money. The Normalized Difference Vegetation Index (NDVI) is commonly used to monitor crop health and productivity. It can help farmers identify areas of the field that may be stressed or nutrient deficient.

**Key words:** smart agriculture, precision agriculture, NDVI, drones

### INTRODUCTION

Over the past decade, the agricultural industry has seen an increasing number of new technologies that are revolutionizing the way farming is done. These advances have enabled more efficient, sustainable, and profitable farming methods that help feed the world's growing population [1].

The term 'smart agriculture' is used to describe a wide range of technologies and practices that contribute to greater efficiency, sustainability and profitability in agriculture. These include the use of drones, automated irrigation systems and sophisticated analytics to monitor and manage crops [2].

Precision Agriculture (PA) is the most intelligent agricultural management system. Precision Agriculture, also known as satellite agriculture or agriculture 4.0, involves the introduction of a range of powerful tools, technologies and machinery to streamline the farming process, reduce costs and ensure production control [3]. This modern method helps growers become more familiar with their cropland and identify both potential soils and the presence of weeds or signs of disease or pest infestation [4]. A comprehensive and detailed analysis of environmental factors at the various stages of the production process (fertilization, planting, spraying and harvesting) makes the entire cultivation process more efficient [5].

### MATERIAL AND METHODS

Advanced analytics are used to track and monitor the health of crops. This technology can provide detailed information on soil conditions, weather patterns, and other environmental factors that can affect crop yields [6].

This information can be used to make better crop selection, seeding, and harvesting decisions. Many authors and researchers support and desire the mass use of drones in agriculture, believing that it would also add a new quality to Precision Agriculture. At the same time, there are other, more cautious authors who fear that the huge amount of data obtained by drones poses a problem, both in its appropriate processing and in its practical application [7].

A drone with GPS and photographic equipment can quickly and efficiently record and map the production area of the farm, accurately and repeatedly show the condition of the surface with

pests, the occurrence of plant diseases, the lack of moisture in the soil and similar processes in the area occupied by the farm [8].

And this is at the exact locations (latitude and longitude) and immediately allow timely and rapid response of the farm staff, which can dramatically streamline and reduce production costs, including the number of workers needed. Suitable types of mini-aircraft agricultural drones are used for regular monitoring/surveying of the condition of crops in agriculture, with the help of which the farmer has a wide and precise view "from the sky" of a given area. The next step is mapping, i.e. creating a precise digital image of the cultivated area, which is usually visualized using the tools of Geographical Information System (GIS) with so-called smart maps [9]. Figure 1 represents the illustration of GIS data being used in Precision Agriculture. When images are taken with multiple camera types and different wavelengths of the solar spectrum, the condition of agricultural crops can be assessed relatively reliably by calculating the Normalized Difference Vegetation Index (NDVI) [10].



**Fig. 1.** Illustration of GIS data being used in Precision Agriculture [11]

Drone can be used to remotely determine various plant parameters that can influence quick decisions: the average Green-Red Ratio Vegetation Index (GRVI), which reflects the green and red regions of the spectrum, Normalized Green-Red Difference Index (NGRDI), the Leaf Area Index (LAI), characterizes the land area covered by green leafy plants, Normalized Difference Vegetation Index (NDVI) is the ratio of reflectance in the near-infrared and red regions of the electromagnetic spectrum, Visible Vegetation Index (VVI) for the amount of vegetation in an image [12].

One of the most frequently used in practice is Normalized Difference Vegetation Index.

Normalized Difference Vegetation Index is a numerical indicator of plant health that reflects the extent and quality of vegetation cover in a given area of a field. Figure 2 represents Normalized Difference Vegetation Index soil image. Normalized Difference Vegetation Index is calculated from satellite images and depends on the degree of absorption and reflection of light waves.

The Normalized Difference Vegetation Index varies throughout the season. Its values differ at each stage of plant development. At the beginning of the growing season the index increases, during the flowering period it stops and as the plant matures the Normalized Difference Vegetation Index decreases.



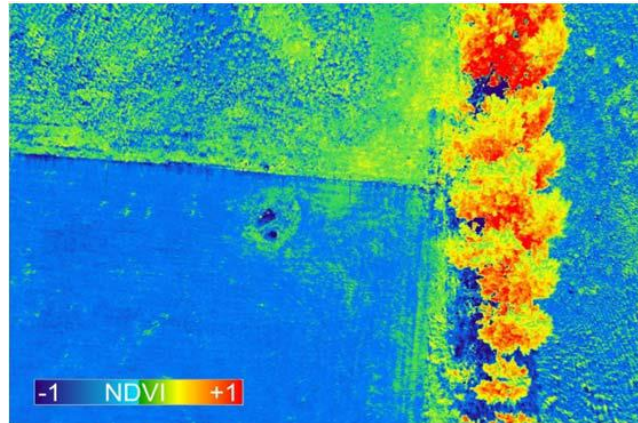


Fig. 2. NDVI image of soil [13]

Depending on soil fertility, weather conditions and cultivation techniques, the biomass growth rate varies. Therefore, it is easy to compare the health of plants during vegetation using the average Normalized Difference Vegetation Index value: In some fields plants grow faster (better) and in others slower (worse) [14].

To analyze the health status of plants, the absorption and reflection values of red (Red) and infrared (Nir) rays should be compared. NDVI values range from 0 to 1. In Figure 3 we can see how Normalized Difference Vegetation Index is calculated.

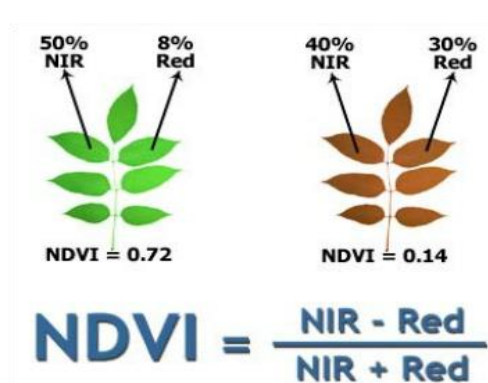


Fig. 3. Normalized Difference Vegetation Index calculation formula [15]

Because of this relationship between leaf area and NDVI value, NDVI can be used as a tool to detect crop stress caused by environmental factors and disease outbreaks. The NDVI value of diseased plants is lower than that of healthy plants, so it can be used as an indicator of plant health. Figure 4 illustrates an NDVI image showing stressed and well watered crop.

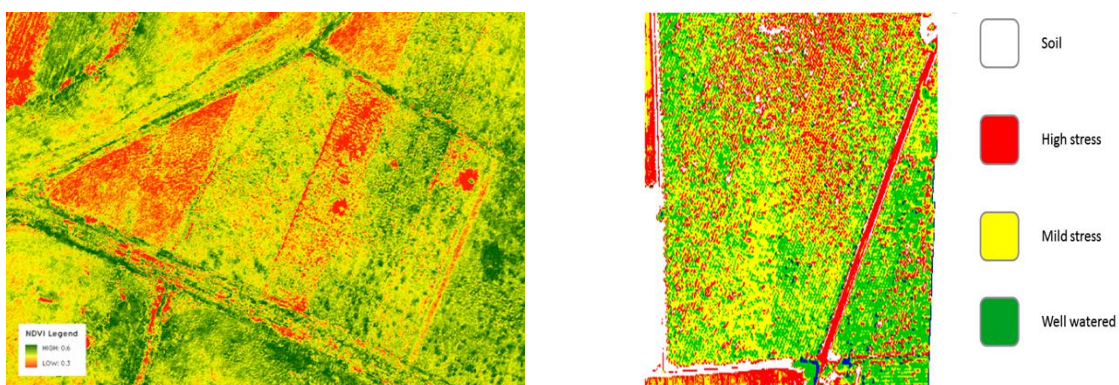


Fig. 4. NDVI image showing stressed and well watered crop [16]

## RESULTS AND DISCUSSION

These previously presented methods, collecting neural network data is done with drones automatically just like collecting NDVI data, all in idea to feed the population. According to the "The 2030 Agenda for Sustainable Development" plan, United Nations (UN) and the international community have set a goal to end hunger by 2030. However, the latest figures released by the World Health Organization (WHO) do not look encouraging enough to support the agenda, as more than 800 million people worldwide are affected by food shortages, or one in nine people. Although these numbers are alarming in themselves, the quality of food is even more shocking. In addition to availability, food quality is another serious issue and even more important [17]. Figure 4 provides a snapshot of the key challenges facing future agriculture in 2050.

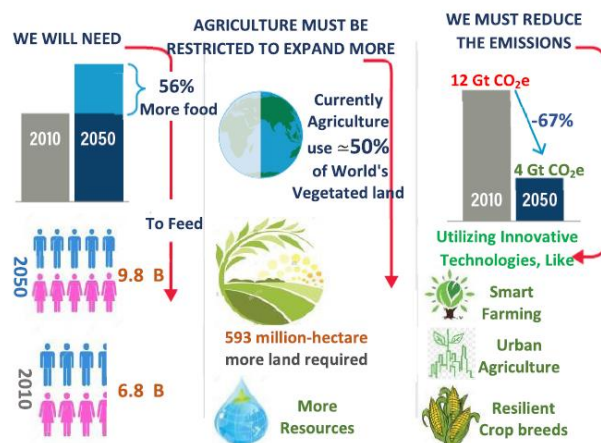


Fig. 4. Major challenges for sustainable future agriculture [18].

Research and innovation in artificial intelligence are driving forces that must be applied to agriculture as soon as possible. With the help of ambitious programs, new technologies and legal regulations, precision agriculture will meet the world's demands and food needs.

Drones are certainly a solution in terms of equipment resources and intelligent machines that need to join conventional machines and will make a significant contribution to precision agriculture.

Through robots and drones in particular, precision agriculture is one of the main beneficiaries of artificial intelligence because it is the sector that must provide food resources.

## CONCLUSION

Given this scenario, agriculture of the future is expected to evolve into a high-tech industry in which networked systems will have the luxury of artificial intelligence and Big Data facilities. The resulting systems will merge into a single entity combining agricultural machinery and management, from seeding to production forecasting. By incorporating advanced technologies such as agricultural robots, Drones, Big Data and cloud computing, Internet of things, agriculture can enter a new era of super fusion. This paper represents an introduction to the subject I will be addressing during my doctoral studies, which began last month.

## ACKNOWLEDGEMENT

The first author acknowledges Petroleum-Gas University of Ploiesti and Prof. Nicolae Paraschiv for their encouragement and support as a PhD student applying for a position reserved for Romanian diaspora students to pursue a doctoral thesis in the field of Systems Engineering with the topic on Smart Agriculture, starting in 2023.

## REFERENCES

- [1] M. Zhang, H. Li, W. Sheng, R. Qiu, Z. Zhang, Unmanned Aerial Systems in Precision Agriculture (2022).
- [2] M. Hassanalian, A. Abdelkefi. Classifications, applications, and design challenges of drones: A review. *Progress in Aerospace Sciences* 91 (2017) 99-131.
- [3] <https://www.agro.basf.ro/ro/stiri/basf-in-camp/agricultura-de-precizie-ce-este-cum-ajuta-fermierii.html>
- [4] <https://www.agro.basf.ro/ro/stiri/basf-in-camp/agricultura-de-precizie-ce-este-cum-ajuta-fermierii.html>
- [5] X. Hi, X. An, Q. Zhao, H. Liu, L. Xia, X. Sun, and Y. Guo, State-of-the art Internet of Things in protected agriculture, *Sensors*, vol. 19, no. 8, p. 1833, (2019).
- [6] O. Elijah, T. A. Rahman, I. Orikumhi, C. Y. Leow, and M. N. Hindia, An overview of Internet of Things (IoT) and data analytics in agriculture: Benefits and challenges, *IEEE Internet of Things J.*, vol. 5, no. 5, pp. 3758\_3773, (2018).
- [7] J. Lin, W. Yu, N. Zhang, X. Yang, H. Zhang, and W. Zhao, A survey on Internet of things: Architecture, enabling technologies, security and privacy, and applications, *IEEE Internet Things J.*, vol. 4, no. 5, pp. 1125\_1142, (2017).
- [8] Mico V. Oljača, Kosta Gligorijević, Miloš Pajić, Ivan Zlatanović, Milan Dražić, Dušan Radojičić, Marković Dragan, Simonović Vojislav, Marković Ivana, Milorad Đokić, Zoran Dimitrovski (2016). *Primena drona u poljoprivredi. Zbornik radova DPT-(2016)*. 1-10. Beograd
- [9] <https://www.microdrones.com/en/applications/areas-of-application/search-and-rescue/>.
- [10] Novak, K. Data collection for multi-media GIs using mobile mapping systems, *Geodetical Info Magazine*, (1993) 30-32.
- [11-12] <https://onlinelibrary.wiley.com/doi/10.1002/adsr.202300023>
- [13] <https://support.dronedeploy.com/docs/understanding-ndvi-data>
- [14] [https://www.researchgate.net/publication/344873685\\_Utilizarea\\_indicilor\\_spectrali\\_de\\_vegetatie\\_NDVI\\_din\\_imaginile\\_satelitare\\_pentru\\_delimitarea\\_zonelor\\_de\\_manage\\_mente\\_ale\\_culturilor\\_agricole\\_anuale-\\_Raport\\_S2](https://www.researchgate.net/publication/344873685_Utilizarea_indicilor_spectrali_de_vegetatie_NDVI_din_imaginile_satelitare_pentru_delimitarea_zonelor_de_manage_mente_ale_culturilor_agricole_anuale-_Raport_S2)
- [15] [https://www.researchgate.net/publication/344873685\\_Utilizarea\\_indicilor\\_spectrali\\_de\\_vegetatie\\_NDVI\\_din\\_imaginile\\_satelitare\\_pentru\\_delimitarea\\_zonelor\\_de\\_manage\\_mente\\_ale\\_culturilor\\_agricole\\_anuale-\\_Raport\\_S2](https://www.researchgate.net/publication/344873685_Utilizarea_indicilor_spectrali_de_vegetatie_NDVI_din_imaginile_satelitare_pentru_delimitarea_zonelor_de_manage_mente_ale_culturilor_agricole_anuale-_Raport_S2)
- [16] Generate 2D and 3D information, purely from images with Pix4D, Pix4D, <<https://pix4d.com/>> (14 March 2017 ).
- [17] World Population Projected to Reach 9.8 Billion in 2050, and 11.2 Billion in 2100. Accessed: Apr. 18, 2019. Available: <https://www.un.org/development/desa/en/news/population/world-population-prospects-2017.html>
- [18] [www.semanticscholar.org/paper/Internet-of-Things-\(IoT\)-Based-Smart-Agriculture%3A-Ayaz-Ammad-Uddin/67b23d81b79ce8789dbc62c9be436d8936e34020](http://www.semanticscholar.org/paper/Internet-of-Things-(IoT)-Based-Smart-Agriculture%3A-Ayaz-Ammad-Uddin/67b23d81b79ce8789dbc62c9be436d8936e34020)



## COMPARISON OF COAL TRANSPORT WITH TRUCKS AND CONVEYORS AT THE SURFACE MINE BOGUTOVO SELO

Radan Lazic<sup>1</sup>, Ljiljana Radovanović<sup>1</sup>, Ivan Palinkaš<sup>1</sup>, Jasmina Perišić<sup>2</sup>

<sup>1</sup>University of Novi Sad, Technical Faculty "Mihajlo Pupin", Zrenjanin, Serbia

<sup>2</sup>The University "Union - Nikola Tesla", Faculty of Informatics and Computer Science, Belgrade, Serbia

e-mail: [ljiljana.radovanovic@tfzr.rs](mailto:ljiljana.radovanovic@tfzr.rs)

**Abstract:** The reason for deciding to work on this topic stemmed from the fact of a good knowledge of the surface mine and the transport located on the said mine. The idea of this work is to show individually, and finally compare the transport of coal with trucks as well as the transport with belt conveyors at the surface mine Bogutovo Selo. The purpose of this paper is to find out which of the mentioned transports is more efficient and of better quality for use, or maybe both are necessary for an open pit mine, based on the results obtained, after conducting a survey among open pit mine employees.

**Key words:** biodiesel, production, energy fuel

### INTRODUCTION

Transport in surface mines is the most important and complex process in surface mining technology. The capacity of mining and disposal machines, mining productivity and ore substance production costs largely depend on its organization [1].

The main purpose of transport in surface mines is to move overburden and useful substances from the working face of the excavator to the place of unloading. Transport on surface excavations has its own specificities, which are mainly the following [1]:

- relatively short transport distances that, as a rule, do not exceed 10 km,
- excavation and disposal sites change their position in space and time, and transversal movement of transport communications is necessary ,
- there are also large climbs in order to export the ore mass to the surface,
- for the better use of mining machinery and means of transport, it is necessary to mutually harmonize the parameters of mining transport equipment, etc.

Transport on surface mines takes place according to an established cycle, the duration of which depends on the time of loading, movement of full and empty transport means, unloading, maneuvering and stoppages in transport. All these operations are performed with or without interruptions, ie. continuously, and according to the mode of action, transport on surface excavations can be divided into [1]:

- transport with intermittent action, which includes: railway transport with locomotive traction, automobile and tractor transport, scraper transport, etc.
- transport without interruption (continuous transport), which includes: transport by belt conveyors, hydraulic, railway with an endless rope, etc.
- transport without interruption (continuous transport), which includes: transport by belt conveyors, hydraulic, railway with an endless rope, etc.

The choice of the type of transport for specific surface mining conditions is determined on the basis of the elements of deposit of the ore substance, the character, shape and size of the deposit, the period of exploitation, the amount of material or cargo that needs to be transported in a certain period of time, the length of the slope of the transport roads, the

method of digging and depositing tailings, ways of receiving ore substance, climatic and other conditions, etc. [1]. When choosing a means of transport, you should also know the following elements:

- the type and physical, chemical and mechanical properties of the material to be transported (looseness of the material in a loose state, brittleness, size of pieces, temperature, etc.),
- method of loading and unloading, • working environment in which means of transport will work (dustiness, temperature changes, humidity, climate, etc.),
- dimensions of facilities or machinery where loading is carried out, i.e. the unloading or passage of transport means,
- the capacity and mode of operation of the loading machinery, as well as the excavation and disposal technology.
- direction and transport distances, etc.

### **Loading-transport systems**

A natural reaction to the growing negative impact on the business environment, represents the permanent development of the used technology and technological possibilities. In addition to the fact that significant technological progress has been achieved in certain sectors, when it comes to the existing loading and transport systems, essential progress has been absent. Existing types of equipment included in loading and transport systems have been in use for several decades. The fact is that with each new iteration, the technical and exploitation characteristics of the equipment changed (lower operating costs, higher productivity, easier and safer handling), while the technology, i.e. technological schemes of system operation, essentially remained the same.

Baucom [7] states that during the past decade, of the many technological changes in mining, the most significant impact is actually related to changes (increase) in dimensions, that is, the capacity of existing types of equipment. The author states that the general concept "Bigger is better" is generally accepted and applied anxiously by a large number of the most important mining companies. This is also confirmed by Morton [8], however, he presents the opinions of relevant experts Joseph T. (Alberta University) and Ebrahimi A. (SRK Vancouver), who think that the space for influencing productivity and reducing costs through increasing the capacity of equipment is increasingly narrowing. The reason for this lies in the fact that there are less and less large mines that can infrastructurally support more capacitive equipment. This is also confirmed by Morton [8], however, he presents the opinions of relevant experts Joseph T. (Alberta University) and Ebrahimi A. (SRK Vancouver), who think that the space for influencing productivity and reducing costs through increasing the capacity of equipment is increasingly narrowing. The reason for this lies in the fact that there are less and less large mines that can infrastructurally support more capacitive equipment.

The development of mechanization itself is accompanied by significant scientific interest in loading and transport systems. When it comes to discontinuous systems, scientific attention is most often focused on the development of new optimization algorithms to solve previously recognized problems.

The largest number of papers on the topic of discontinuous loading and transport systems is related to the excavator-truck system, while other loading and transport variants are significantly less represented.

To a significant extent, there are only works that deal with the technology of dredge line excavators [9], which is in line with the high prevalence of draglines in overburden excavation



processes. Despite their peculiarities, the mentioned topics largely overlap with each other. Burt and Caccetta [10] state that within the problem of selection of the exploitation method, the selection of the type of equipment is made at the same time. And in addition to the fact that in such cases only the type and basic capacity are determined (not the details of the equipment selection), the selection of the exploitation method already sets relatively narrow limits, that is, reduces the potential set of solutions, especially in the case of loading and transport systems. When defining the exploitation method, the selection of the type of equipment is made based on the conditions that characterize the working environment.

BazzaziOsanloo, Karimi, Bascetin, Kesimal, Bascetin [11] use fuzzy logic in the process of defining equipment in a concrete working environment. The advantage of this approach allows for the inclusion of a large number of influential factors and uncertainty, which is deeply embedded in many parameters, but also implies great experience in the process. A particularly significant impact on scientific considerations and on practice itself was the introduction of the degree of compatibility of excavation with transport equipment within the observed system (Eng. Match factor). Using a heuristic approach, Douglas [12] first introduces the degree of conformity. Using the basics of the set heuristic approach, Morgan and Peterson [13] simplified the formulation. This simplified formulation is much more widely used in practice. The main problem with the aforementioned formulations is that they imply a homogeneous fleet (same type of equipment for both loading and transport), which is often not the case. Burt [10] extends the formulation of the degree of compliance to cases of heterogeneous composition, especially of the transport and loading part of the system, and then also to the case when both components (both loading and transport) are heterogeneous.

Significant progress was made by Burt, Burt et al. [10] by introducing a model for equipment selection in conditions of multiple loading and unloading points, for the case of several considered periods. The success of the authors is reflected in the fact that by using mixed integer programming, they created a model that corresponds to reality to a significant extent, that is, it does not introduce simplifications (one system, one loading and one unloading place).

When it comes to continuous loading and transport systems, the scientific interest and consequently the number of scientific papers is significantly less. This situation is partly determined by the limited possibility of applying continuous systems. Also Stevanović, et al. [14] notes that the reduced flexibility and strict structure of continuous systems significantly reduces the set of potential solutions and thus the space for possible improvements and optimizations. Also, almost entirely, continuous loading and transport systems are functionally related to the mining of lignite coals.

Bearing this in mind, it is not surprising that the author's scientific interest and attention is primarily focused on optimizing the operation of continuous loading and transport systems in the conditions of coal mining. Stevanović [14] states that the largest part of mined coal is intended for the production of electricity in thermal power plants, which is why the goals of surface mining and thermal power plants are strongly connected. For this reason, the general feature of scientific works related to continuous systems is the simulation of the entire production process from excavation to the landfill of the thermal power plant.

This approach implies the development of robust and complex simulation algorithms for monitoring the flow and characteristics of the material (usually coal) from the mining site, through the transport system, to crushers, landfills or loading into trains for the thermal power plant.

The development of scientific and practical methods, especially supported by the development of information technologies, puts in the foreground the possibility of an integral overview of the entire process of exploitation of useful mineral raw materials.

The need for integral solutions is promoted by many authors, and the reasons for this understanding arise from the very nature of the mining activity, that is, the mutual dependence of practically all phases in the development of the project. Namely, in the process of planning surface mines, defining the exploitation system is an unavoidable and fundamentally important step. In order to obtain the conditions for defining the exploitation

system, it is necessary to optimize the limits of the surface mine, construct the final contour of the mine and define the reserves of ore and tailings, provide the location and space for the disposal site, as well as develop a detailed plan for the development of mining works.

### Surface mining Bogutovo Selo

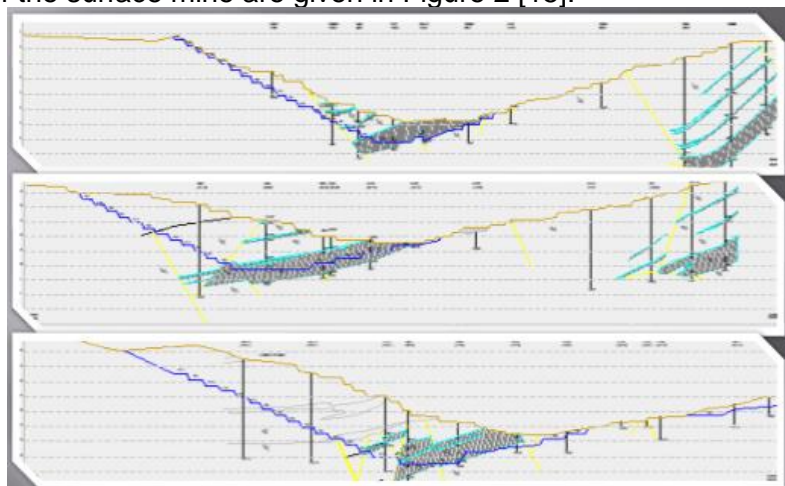
The surface mine Bogutovo Selo began to be exploited in 1978. The projected coal production capacity of the surface mine "Bogutovo Selo" Ugljevik is 1,750,000 tons per year. The Bogutovo Selo coal deposit is divided by faults into several blocks that are explored and exploited as separate fields [15]. The location of the Bogutovo Selo mine is shown in Fig. 1:



**Fig. 1.** Location of the Bogutovo Selo mine [15]

The ore bodies are composed of three complex layers: the main coal layer of almost continuous distribution, and the first and second secondary coal layers [16]. The formation with the main coal layer has a bedding direction towards the north-northeast with dip angles higher in the deeper part (20-25°) and lower in the outcrop part of the area (10-15°). The average thickness of pure coal of the main coal seam is about 17.4 m, of the first coal seam 2.43 m, and of the second coal seam 2.31 m.

The area is 2.2 [km] <sup>2</sup>. The maximum depth of the mine in the South District is 120 m. Cross profiles of the surface mine are given in Figure 2 [15]:



*Cross profile 8-8 'of open pit mine "Bogutovo Selo"*  
*Cross profile 14-14 'of open pit mine "Bogutovo Selo"*  
*Cross profile 18-18 'of open pit mine "Bogutovo Selo"*  
**Fig. 2.** Transverse profiles, 1, 2 and 3 [15]

### RESEARCH METHODOLOGY

The problem of this research is to provide an overview of trucks and belt conveyors at the surface mine Bogutovo Selo. The subject of this research is the advantages and disadvantages of both types of transport, based on the results of a survey conducted by respondents from the Bogutovo Selo surface mine. The task of this research is the



comparison of coal transport by trucks and belt conveyors at the surface mine Bogutovo Selo.

The goal of this research is to compare truck and belt conveyor transport based on the results obtained from the conducted survey and determine which one has a greater purpose.

Main hypothesis: The availability of trucks and belt conveyors as transport machines on surface mines is of great importance for the productivity of excavation and delivery of excavated material.

The sample will be ten employees at the mine, and the research site will be the surface mine Bogutovo Selo.

## EXPERIMENTAL PART

The mine and the Ugljevik Thermal Power Plant represent a joint entity within the Elektroprivreda Republika Srpska (main activity is electricity production). The projected coal production capacity of the surface mine "Bogutovo Selo" Ugljevik is 1,750,000 tons per year. Based on previous research, design and works performed on the "Bogutovo Selo" surface mine, 95% of the total quantities planned for excavation and loading can be excavated with hydraulic and rope bucket excavators, and 3.0-3.5% must be pre-drilled and to mine.

### Survey of employees at the surface mine Bogutovo Selo

10 employees at the surface mine Bogutovo Selo participated in the survey. All employees are male. In the survey there were 10 questions with offered answers, on which it was necessary to circle the one that was considered valid by the respondent. The questions were as follows:

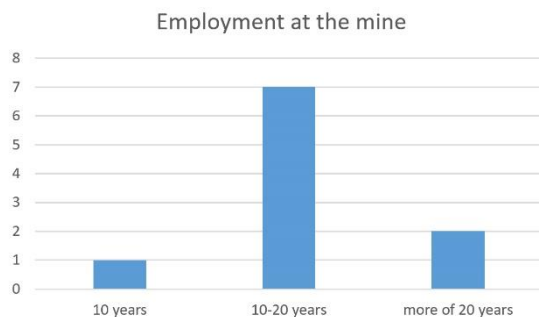
1. Question: How long have you been working on the surface mine Bogutovo Selo?

- a) About 10 years
- b) Between 10-20 years
- c) More than 20 years

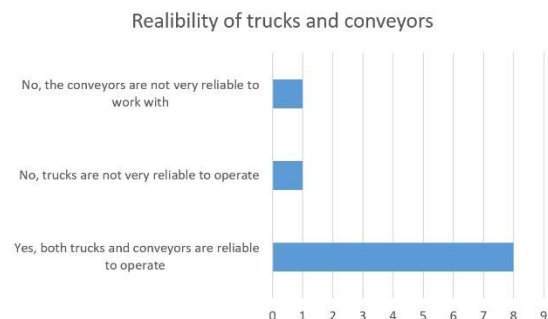
Most of the employees indicated that they had been employed between 10-20 years, while the least number of employees were up to 10 years.

2. Question: Do you think that the reliability of working with trucks and transporters on the mine is at an enviable level?

- a) Yes, both trucks and conveyors are reliable for operation
- b) No, trucks are not very reliable for operation
- c) No, conveyors are not very reliable for operation



**Fig. 3.** Years of work of employees at the Bogutovo Selo mine



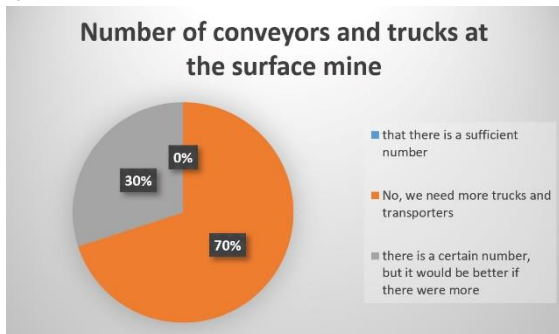
**Fig. 4.** Reliability of trucks and conveyors

We can see from graph number 2 that the employees mostly marked the answer under a, that both trucks and transporters are reliable for work at the Bogutovo Selo surface mine.

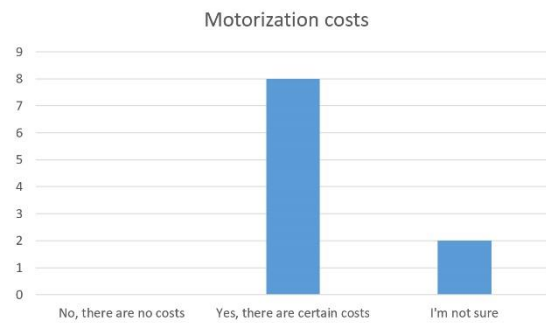
3.Question: Is there a sufficient number of trucks and belt conveyors at the surface mine to carry out their activities?

From the graph and based on the answers of the respondents, it can be seen that there is a need for trucks and transporters, that most of the respondents think so.

4. Are there large motorization costs when it comes to trucks and belt conveyors in the open pit?



**Fig. 5.** Number of trucks and transporters at the surface mine



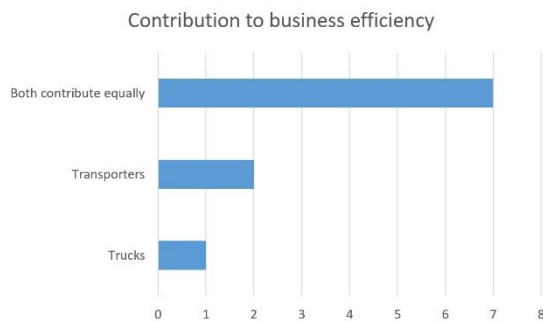
**Fig. 6.** Motorization costs

Based on the answers provided, the employees mostly indicated that there are certain costs for the motorization of trucks and belt conveyors.

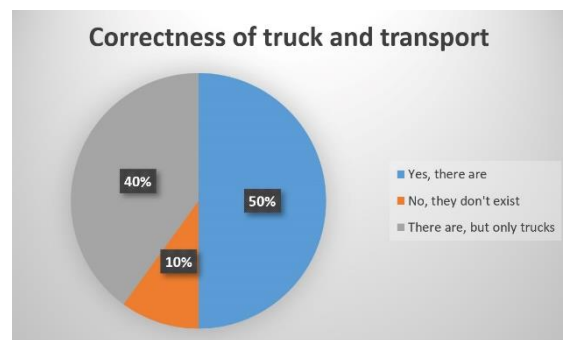
5. Do trucks or belt conveyors contribute more to business efficiency?

The respondents believe that trucks and transporters contribute equally to business efficiency.

6. Are there any trucks or conveyors on the mine that are not in operation due to malfunctions?



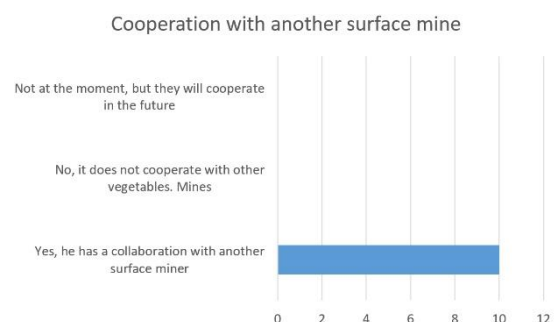
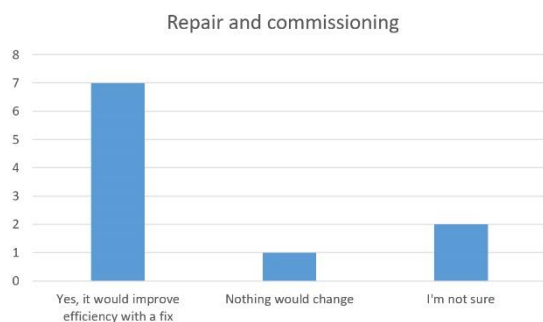
**Fig. 7.** Contribution to business efficiency



**Fig. 8.** Correctness of trucks and transporters

50% of the respondents believe that there are also trucks and transporters that are not in operation due to their lack of maintenance.

7. If there are trucks and conveyors that are not in operation at the moment, would their repair and putting them into operation improve the efficiency of operations on the mine?

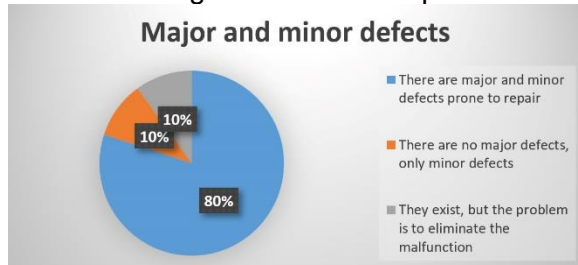


**Fig. 9.** Repair and commissioning of conveyors and trucks

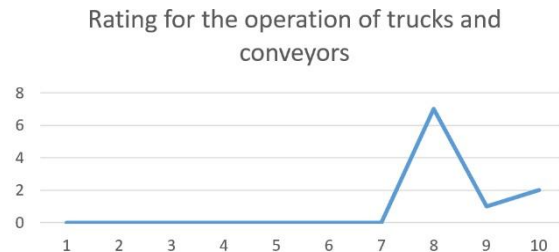
**Fig. 10.** Cooperation with another surface mine

There is a visible difference in the answers, and most of the answers were given by the respondents under a, where they believe that the efficiency of business would be improved if the trucks and transporters that are currently not in operation were repaired and reactivated on the mine.

8. Does the Bogutovo Selo mine cooperate with any other mine in the immediate vicinity in terms of renting trucks and transporters?



**Fig. 11.** Major and minor defects



**Fig. 12.** Ratings for the operation of trucks and conveyors at the surface mine Bogutovo Selo

It is clear that there is cooperation between the Bogutovo Selo surface mine and another surface mine, and all ten respondents confirmed this with their answers.

9. Are there major and minor defects on trucks and transporters that are easy to repair?

In their answers, the employees confirmed that there are defects (both major and minor) that are prone to repair, and this was indicated by the largest number of respondents.

10. Rate the operation of trucks and conveyors at the surface mine Bogutovo Selo with a score of 1-10.

From the attached graph, we can conclude that the employees, surveyed, rated the operation of trucks and transporters with a score of 8.

## RESEARCH RESULTS

Based on the survey that was conducted among 10 employees at the surface mine Bogutovo Selo, conclusions summarized from all ten graphs can be presented. The first graph showed that the maximum number of people employed in surface mining is between 10-20 years, that graph two shows the need for more trucks and transporters in order to carry out the work smoothly, then graph three shows the existence of certain costs of truck motorization and belt conveyors. Furthermore, graph four gives an insight into the fact that trucks and transporters are equally active in contributing to business efficiency, then the fifth graph shows the existence of trucks and transporters that are not in operation due to their inactivity. The sixth graphic shows the difference in the answers, and most of the answers were given to improve the efficiency of operations, if the trucks and transporters that are currently not in operation would be repaired and reactivated at the surface mine. The seventh graphic clearly shows that there is cooperation between the Bogutovo Selo open pit mine and another open pit mine, while the eighth confirms that there are malfunctions (both major and minor) that are prone to repair, and finally, the respondents rate the operation of trucks and conveyors at the Bogutovo Selo open pit mine with a score of 8 Questions 4, 5, 6, 7, 8 support and confirm the hypothesis of this research.

## CONCLUSION

Based on the theory of transport in surface mines as well as the concrete description of the surface mine Bogutovo Selo, it can be concluded that it is essential and of great importance

for an open-pit mine to have all the necessary transporters, which was confirmed in the paper and the main hypothesis set for the purpose of comparing coal transport with trucks and belt conveyors. Taking the surface mine Bogutovo Selo as the place where the employees were surveyed, it can be concluded that trucks and belt conveyors are equally useful. The recommendation is to improve the business with newer ones or to return old trucks and belt conveyors to function.

## REFERENCES

- [1] Ignjatović, D., *Machines and devices for transport in surface mines*. Script., University of Belgrade, Faculty of Mining and Geology, Belgrade, 2010.
- [2] Whittle, J., *The facts and fallacies of open pit optimisation*, Whittle Programming Pty. Ltd., Australia, 1989.
- [3] Osanloo, M., Gholamnejad, J., Karimi, B., Long-term open pit mine production planning: a review of models and algorithms. *International Journal of Mining, Reclamation and Environment*, 22 (1), 3-35, 2008.
- [4] Dagdelen, K., *Optimum multi period open pit mine production scheduling*. PhD Thesis, Colorado School of Mines, 1985.
- [5] Pana, M., Carlson, T., *Description of a computer technique used in mine planning of the Utah Mine of Kennecott Copper Corp*. 6th APCOM, 1966.
- [6] Barnes, R. J., *Optimizing the ultimate pit*. PhD Thesis, Colorado School of Mines. Arthur Lakes Library, 1982.
- [7] Baucom, J., *The Evolution of Mining Trucks is Changing Interactions and Productivity at Minesites*. Pincock, Allen and Holt, a division of Runge Inc, 2011.
- [8] Morton, J., *Is the Ultra-class Truck Dream Dead?* *Engineering and Mining Journal*, 218 (9), 32-36. 2017.
- [9] Aspinall T., Isles, P., Davidson, C., *Strip Mining*. In: MARTIN, C. H. & HARGRAVES, A. J. (eds.) *Australasian coal mining practice*. Melbourne, Australia: Australasian Institute of Mining and Metallurgy [AusIMM], 1993.
- [10] Internet source: Burt, C., Caccetta, L., *Equipment Selection for Surface Mining: A Review - Draft paper*. website: [http://www.optimizationonline.org/DB\\_FILE/2013/04/3831.pdf](http://www.optimizationonline.org/DB_FILE/2013/04/3831.pdf)
- [11] Bazzazi, A. A. Osanloo, M., Karimi, B., *A new fuzzy multi criteria decision making model for open pit mines equipment selection*. *Asia-Pacific Journal of Operational Research*, 28 (03), 279-300, 2011.
- [12] Douglas, J., *Prediction Shovel-Truck Production: A Reconciliation Of Computer And Conventional Estimates*, Technical report no. 37, prepared for: Stanford University, California, 1964.
- [13] Morgan, W., Peterson, L., *Determining shovel-truck productivity*. *Mining Engineering*, 20 (12), 76-80. 1968.
- [14] Stevanović, D., *Optimization and planning of surface mines using stochastic models*. Doctoral dissertation, University of Belgrade, Faculty of Mining and Geology, 2015.
- [15] Milošević, D., Maksimović, M., Perić, N., *Optimization of coal exploitation at the surface mine Bogutovoselo*, PP presentation, 2018.
- [16] Internet source: <https://lat.rtrs.tv/vijesti/vijest.php?id=320140>